

Contents

- 1. Documentation version history4
- 2. Preface77
- 3. Definitions and abbreviations78
- 4. Environments.....79
- 5. Suppliers' digital certificates79
- 6. Recommendation for API client.....80
 - 6.1 SYNC.....80
 - 6.2 ASYNC82
 - 6.2.1 DataHub order processing retry policy85
 - 6.2.2 Order status flows.....85
 - 6.2.3 Recommendations.....86
 - 6.3 JSON request logic.....86
 - 6.4 Change notifications87
 - 6.4.1 Register notification88
 - 6.4.2 Track status89
 - 6.4.3 Cancel notification90
 - 6.5 Meter reading declaration.....91
 - 6.5.1 Get the latest reading data91
 - 6.5.2 Post new reading data94
 - 6.6 Access Rights.....95
 - 6.6.1 Register access right95
 - 6.6.2 List all access rights.....97
 - 6.6.3 Cancel access right98
 - 6.6.4 Access right integration with data order module99
- 7. DataHub Gateway API documentation99
 - 7.1 Declaration controller.....99
 - 7.1.1 GET /gateway/supplier/v3/get-declaration-data99

7.1.2	POST /gateway/declaration/v2/reading/list	106
7.1.3	POST /gateway/supplier/send-declaration-data	114
7.2	Access right controller	120
7.2.1	POST/gateway/access-right/v2/list.....	120
7.2.2	POST /gateway/access-right	128
7.2.3	POST /gateway/access-right/{accessRightId}/cancel	134
7.3	Order controller.....	136
7.3.1	POST/gateway/order/v2/list.....	136
7.3.2	POST/gateway/order/v2/data-hr-15min-mtr-lvl.....	141
7.3.3	POST/gateway/order/v2/data-hr-15min-obj-lvl	144
7.3.4	POST/gateway/order/v2/{orderType}	150
7.3.5	GET/gateway/order/{orderId}/data-hr-15min-obj-lvl	154
7.3.6	GET/gateway/order/{orderId}/data-hr-15min-mtr-lvl	159
7.3.7	GET/gateway/order/{orderId}/bill-2s2s-b2b	162
7.3.8	GET/gateway/order/v2/{orderId}/report-obj	167
7.3.9	GET/gateway/order/{orderId}/bill-bss-b2c	171
7.3.10	GET/gateway/order/{orderId}/bill-bss-b2b	186
7.3.11	GET/gateway/order/{orderId}/count.....	199
7.3.12	POST/gateway/order/v2/data-hr-15min-mtr-lvl-acr	202
7.3.13	POST/gateway/order/v2/data-hr-15min-obj-lvl-acr.....	205
7.3.14	POST/gateway/order/data-sum-obj-lvl-acr	210
7.3.15	POST/gateway/order/v2/report-obj-acr.....	213
7.3.16	GET /gateway/order/{orderId}/data-hr-15min-obj-lvl-acr	215
7.3.17	GET /gateway/order/{orderId}/data-hr-15min-mtr-lvl-acr.....	220
7.3.18	GET /gateway/order/v2/{orderId}/report-obj-acr	224
7.3.19	GET /gateway/order/{orderId}/data-sum-obj-lvl-acr.....	227
7.3.20	POST/gateway/order/data-hr-15min-history-changes	231
7.3.21	GET/gateway/order/{orderId}/data-hr-15min-history-changes	235
7.3.22	POST/gateway/order/balance-data (will be deployed in 04.16).....	238
7.3.23	GET/gateway/order/{orderId}/balance-data (will be deployed in 04.16).....	241

7.3.24	POST/gateway/order/balance-by-generation-type (will be deployed in 04.16)	244
7.3.25	GET/gateway/order/{orderId}/balance-by-generation-type (will be deployed in 04.16)	247
7.4	Object controller	251
7.4.1	POST /gateway/object/v2/my/active/list	251
7.4.2	POST /gateway/object/v2/all/active/list	265
7.5	Notification contract controller	276
7.5.1	POST /gateway/notification/v2/contract/list	276
7.5.2	POST /gateway/notification/contract	290
7.5.3	POST /gateway/notification/{notificationId}/contract/cancel	316
7.6	Notification contract termination controller	318
7.6.1	POST /gateway/notification/v2/contract/termination/list	318
7.6.2	POST /gateway/notification/contract/termination	328
7.6.3	POST /gateway/notification/{notificationId}/contract/termination/cancel	338
7.7	Notification contract object supply state controller	340
7.7.1	POST /gateway/notification/v2/contract/object/supply-state/list	340
7.7.2	POST /gateway/notification/contract/object/supply-state	348
7.7.3	POST /gateway/notification/{notificationId}/contract/object/supply-state/cancel	353
7.8	Notification cancellation controller	355
7.8.1	POST /gateway/notification/v2/cancellation/list	355
7.8.2	POST /gateway/notification/cancellation	361
7.8.3	POST /gateway/notification/{notificationId}/cancellation/cancel	367
7.9	Notification contract tariff plan controller	369
7.9.1	POST /gateway/notification/v2/contract/tariff-plan/list	370
7.9.2	POST /gateway/notification/contract/tariff-plan	377
7.9.3	POST /gateway/notification/{notificationId}/contract/tariff-plan/cancel	384
7.10	Notification contract contact controller	387
7.10.1	POST /gateway/notification/v2/contract/contact/list	387
7.10.2	POST /gateway/notification/contract/contact	395
7.10.3	POST /gateway/notification/{notificationId}/contract/contact/cancel	401
7.11	Statistic controller	404

7.11.1	Statistic names	404
7.11.2	GET /gateway/statistic/list	407

1. Documentation version history

The table below provides information on document version history:

Version	Date	Description
0.1	2019-11-15	Initial document version.
0.2	2019-11-18	Updated bdHorder Gateway component internet addresses by adding ports.
0.3	2019-11-18	DataHub Sandbox and Production manual.
0.4	2020-01-04	API changes from XML to JSON.
0.5	2020-09-07	Existing documentation changed by adding information about request/response parameters, added fields types and description, explanations, etc.
0.6	2020-09-21	New methods added, existing methods changed by adding personal and company code parameters, customerCode and objectCode fields renamed, other changes.
0.6.1	2020-09-22	<ul style="list-style-type: none"> • Existing Supplier change notification method will remain and new method (/supplier/v2/supplier-change-notifications) deployed as version v2; <ul style="list-style-type: none"> ○ response JSON model added to both Supplier change notification methods (v1 and v2); ○ new rules explanation added; ○ Some error messages changed; • /client/client-objects-information method: <ul style="list-style-type: none"> ○ success response code changed from to 201 to 200; ○ changes in method rules table; ○ changes in method error messages table; • /client/client-objects-information (new) method : <ul style="list-style-type: none"> ○ method was moved to supplier-change-notification controller; ○ response model contractType field will return <i>null</i> till next DataHub API version update; • POST /client/data-access-rights (new) <ul style="list-style-type: none"> ○ Request structure was changed (object list was removed) ○ Some error messages changed; • GET /client/granted-objects (new) <ul style="list-style-type: none"> ○ Header count parameter value can be only numbers; ○ Response structure was changed (objects list was removed) ○ Some error messages changed; • POST /client/data-access-rights/delete (new) <ul style="list-style-type: none"> ○ Request structure was changed (object list and customers list were removed) ○ Some error messages changed;

		<ul style="list-style-type: none"> • Reports controller: <ul style="list-style-type: none"> ○ POST /reports/accounting-data-pack-b2c and POST /reports/objects-data-pack response models changed; • GET /data/data-orders/{orderId}/data method response changes: <ul style="list-style-type: none"> ○ File Valandiniai <...>.csv - P- field added; ○ File Suminiai <...>.csv - D1, D2, N1, N2 fields added; ○ File Objektai <...>.csv - automation Level field will return new values;
0.6.2	2020-10-07	<p>Added information about Declaration process:</p> <ul style="list-style-type: none"> • Supplier-change-notification v2 <ul style="list-style-type: none"> ○ One Error code was removed (error code 4 in previous documentation). • Declaration controller section was created <ul style="list-style-type: none"> ○ Technical description was added: <ul style="list-style-type: none"> ▪ GET /supplier/get-declaration-data - method to get all required data about client to implement declaration process; ▪ POST /supplier/send-declaration-data - method to send clients' declaration data to DSO;
0.6.3	2020-10-16	<p>Added additional information in Declaration GET /supplier/get-declaration-data method data model:</p> <ul style="list-style-type: none"> ○ clientId and scaleType information;
0.6.4	2020-11-06	<ul style="list-style-type: none"> • Added response error codes in POST /data/data-orders and GET /data/data-orders/{orderId}/data methods. • GET /supplier/get-declaration-data <ul style="list-style-type: none"> ○ readings[].conversionPoss - changed data type from string to boolean ○ readings[].scales[].readingFromDate - date format specified to YYYY-MM-DDThh:mm:ss • POST /supplier/send-declaration-data <ul style="list-style-type: none"> ○ conversion - changed data type from string to boolean ○ dataWriteDate - date format specified to YYYY-MM-DDThh:mm:ss
0.6.5	2020-11-23	<p>Method supplier-change-notifications: added new error (202 Object number "{objectNumber}" repeats.)</p> <p>Changed URL parameters in methods: added first and count.</p> <ul style="list-style-type: none"> • GET supplier/get-declaration-data • GET client/granted-objects • GET reports/accounting-data-pack-b2b • GET reports/accounting-data-pack-b2b-meters-level • GET reports/accounting-data-pack-b2c

		<ul style="list-style-type: none"> • GET reports/objects-data-pack
0.6.6	2020-12-08	New method version POST /reports/accounting-data-pack-b2c added new fields for "Additional component of distribution service" (Sppd).
0.6.7	2020-12-08	<p>In methods POST /reports/accounting-data-pack-b2c, POST /reports/accounting-data-pack-b2b and POST /reports/accounting-data-pack-b2b-meters-level added new fields:</p> <ul style="list-style-type: none"> • AccumulatedUploadedConsumptionAmount; • AccumulatedRaisedConsumptionAmount. <p>Old field AccumulatedTransferredConsumptionAmount will be deleted after the transition period (about 1 month).</p>
0.6.8	2021-01-29	<p>Updated JSON specification of POST /reports/accounting-data-pack-b2b-meters-level method. Added new fields:</p> <ul style="list-style-type: none"> • AccumulatedBeginningConsumptionAmount • AccumulatedEndConsumptionAmount • ConsumedElectricityConsumptionAmount • ConsumedElectricityReadingsFrom • ConsumedElectricityReadingsTo • ConsumptionConversionActCreateDate • ConsumptionConversionActFrom • ConsumptionConversionActNumber • ConsumptionConversionActTo • ConsumptionState • ConsumptionStateFrom • ConsumptionStateTo • EnergyObtainedConsumptionAmount • EnergyObtainedDateFrom • EnergyObtainedDateTo • EnergyObtainedPowerKw • GridSuppliedConsumptionAmount • GridSuppliedReadingsFrom • GridSuppliedReadingsTo • InstalledConsumptionPower • InstalledGeneratingPower • PaymentType • PowerPlantCapacityAmountNoVAT • PowerPlantCapacityConsumptionAmount • PowerPlantCapacityDateFrom • PowerPlantCapacityDateTo • PowerPlantCapacityPriceEur

		<ul style="list-style-type: none"> • PowerPlantCapacitySource • PowerPlantCapacitySourceDateFrom • PowerPlantCapacitySourceDateTo • PowerPlantCapacityUnit • ReportingPeriod • Service <p>Renamed fields:</p> <ul style="list-style-type: none"> • ReadingsSourceTypeCodeDatahub to ReadingsSource • PermanentHomePliusAmountNoVAT to PermanentHomePlusAmountNoVAT <p>Removed fields:</p> <ul style="list-style-type: none"> • MetersMalfunctionActCreateDate • MetersMalfunctionActFrom • MetersMalfunctionActNumber • MetersMalfunctionActTo • NotConsumeFrom • NotConsumeTo • TechnologicalCostsReadingsFrom • TechnologicalCostsReadingsTo
0.6.9	2021-02-10	<p>Updated JSON specification of POST /reports/accounting-data-pack-b2b-meters-level method. Added new fields:</p> <ul style="list-style-type: none"> • DdSppdAmountNoVAT • DdSppdConsumptionAmount • DdSppdDiscount • DdSppdPriceEur • DdSppdUnit • MissingEnergySppdAmountNoVAT • MissingEnergySppdConsumptionAmount • MissingEnergySppdDiscount • MissingEnergySppdPriceEur • MissingEnergySppdUnit • NkSppdAmountNoVAT • NkSppdConsumptionAmount • NkSppdDiscount • NkSppdPriceEur

		<ul style="list-style-type: none"> • NkSppdUnit • VkSppdAmountNoVAT • VkSppdConsumptionAmount • VkSppdDiscount • VkSppdPriceEur • VkSppdUnit
0.6.10	2020-02-15	<p>Updated JSON specification of POST /reports/accounting-data-pack-b2b-meters-level method. Added new fields:</p> <ul style="list-style-type: none"> • DdDiscountAmountNoVAT • DdDiscountConsumptionAmount • DdDiscountDiscount • DdDiscountPriceEur • DdDiscountUnit • MissingEnergyDiscountAmountNoVAT • MissingEnergyDiscountConsumptionAmount • MissingEnergyDiscountDiscount • MissingEnergyDiscountPriceEur • MissingEnergyDiscountUnit • NkDiscountAmountNoVAT • NkDiscountConsumptionAmount • NkDiscountDiscount • NkDiscountPriceEur • NkDiscountUnit • VkDiscountAmountNoVAT • VkDiscountConsumptionAmount • VkDiscountDiscount • VkDiscountPriceEur • VkDiscountUnit
0.6.11	2021-02-17	<p>Added additional rules and response errors in:</p> <ul style="list-style-type: none"> ▪ POST /reports/accounting-data-pack-b2c ▪ POST /reports/accounting-data-pack-b2c-count ▪ POST /reports/accounting-data-pack-b2b-meters-level ▪ POST /reports/accounting-data-pack-b2b-meters-level-count ▪ POST /reports/objects-data-pack ▪ POST /reports/objects-data-pack-count ▪ POST /reports/accounting-data-pack-b2b?first={integer}&count={integer} ▪ POST /reports/accounting-data-pack-b2b-count

0.6.12	2021-03-03	<p>Added an additional response error No 13 in:</p> <ul style="list-style-type: none"> ▪ POST /gateway/supplier/send-declaration-data
0.6.13	2021-03-05	<p>Edited the error message rule 8 of the notification creation and the 108 error message text in:</p> <ul style="list-style-type: none"> • POST /supplier/v2/supplier-change-notifications (new)
0.6.14	2021-03-12	<p>Edited the description of the 108 error message</p> <ul style="list-style-type: none"> • POST /supplier/v2/supplier-change-notifications (new)
0.6.15	2021-03-15	<p>Updated JSON specification of POST /reports/accounting-data-pack-b2c method. Added new fields:</p> <ul style="list-style-type: none"> • D1ConsumedElectricityConsumptionAmount • D1ConsumedElectricityReadingsFrom • D1ConsumedElectricityReadingsTo • D1ConsumedElectricityUnit • D1MissingEnergyAmount • D1MissingEnergyAmountNoVAT • D1MissingEnergyConsumptionAmount • D1MissingEnergyIncludedVAT • D1MissingEnergyPriceEur • D1MissingEnergyPriceEurVAT • D1MissingEnergySppdAmount • D1MissingEnergySppdAmountNoVAT • D1MissingEnergySppdConsumptionAmount • D1MissingEnergySppdIncludedVAT • D1MissingEnergySppdPriceEur • D1MissingEnergySppdPriceEurVAT • D1MissingEnergySppdUnit • D1MissingEnergyUnit • D1MissingEnergyViapAmount • D1MissingEnergyViapAmountNoVAT • D1MissingEnergyViapConsumptionAmount • D1MissingEnergyViapIncludedVAT • D1MissingEnergyViapPriceEur • D1MissingEnergyViapPriceEurVAT • D1MissingEnergyViapUnit

- D1PayingRecoveredEnergyAmount
- D1PayingRecoveredEnergyAmountNoVAT
- D1PayingRecoveredEnergyConsumptionAmount
- D1PayingRecoveredEnergyIncludedVAT
- D1PayingRecoveredEnergyPriceEur
- D1PayingRecoveredEnergyPriceEurVAT
- D1PayingRecoveredEnergyUnit
- D1PayingRecoveredMixedAmount
- D1PayingRecoveredMixedAmountNoVAT
- D1PayingRecoveredMixedConsumptionAmount
- D1PayingRecoveredMixedIncludedVAT
- D1PayingRecoveredMixedPriceEur
- D1PayingRecoveredMixedPriceEurVAT
- D1PayingRecoveredMixedUnit
- D1PayingRecoveredPercentConsumptionAmount
- D1PayingRecoveredPercentUnit
- D1PayingRecoveredPowerConsumptionAmount
- D1PayingRecoveredPowerUnit
- D2ConsumedElectricityConsumptionAmount
- D2ConsumedElectricityReadingsFrom
- D2ConsumedElectricityReadingsTo
- D2ConsumedElectricityUnit
- D2MissingEnergyAmount
- D2MissingEnergyAmountNoVAT
- D2MissingEnergyConsumptionAmount
- D2MissingEnergyIncludedVAT
- D2MissingEnergyPriceEur
- D2MissingEnergyPriceEurVAT
- D2MissingEnergySppdAmount
- D2MissingEnergySppdAmountNoVAT
- D2MissingEnergySppdConsumptionAmount
- D2MissingEnergySppdIncludedVAT
- D2MissingEnergySppdPriceEur
- D2MissingEnergySppdPriceEurVAT
- D2MissingEnergySppdUnit
- D2MissingEnergyUnit
- D2MissingEnergyViapAmount
- D2MissingEnergyViapAmountNoVAT
- D2MissingEnergyViapConsumptionAmount
- D2MissingEnergyViapIncludedVAT
- D2MissingEnergyViapPriceEur

- D2MissingEnergyViapPriceEurVAT
- D2MissingEnergyViapUnit
- D2PayingRecoveredEnergyAmount
- D2PayingRecoveredEnergyAmountNoVAT
- D2PayingRecoveredEnergyConsumptionAmount
- D2PayingRecoveredEnergyIncludedVAT
- D2PayingRecoveredEnergyPriceEur
- D2PayingRecoveredEnergyPriceEurVAT
- D2PayingRecoveredEnergyUnit
- D2PayingRecoveredMixedAmount
- D2PayingRecoveredMixedAmountNoVAT
- D2PayingRecoveredMixedConsumptionAmount
- D2PayingRecoveredMixedIncludedVAT
- D2PayingRecoveredMixedPriceEur
- D2PayingRecoveredMixedPriceEurVAT
- D2PayingRecoveredMixedUnit
- D2PayingRecoveredPercentConsumptionAmount
- D2PayingRecoveredPercentUnit
- D2PayingRecoveredPowerConsumptionAmount
- D2PayingRecoveredPowerUnit
- DdConsumedElectricityConsumptionAmount
- DdConsumedElectricityReadingsFrom
- DdConsumedElectricityReadingsTo
- DdConsumedElectricityUnit
- DdMissingEnergyAmount
- DdMissingEnergyAmountNoVAT
- DdMissingEnergyConsumptionAmount
- DdMissingEnergyIncludedVAT
- DdMissingEnergyPriceEur
- DdMissingEnergyPriceEurVAT
- DdMissingEnergySppdAmount
- DdMissingEnergySppdAmountNoVAT
- DdMissingEnergySppdConsumptionAmount
- DdMissingEnergySppdIncludedVAT
- DdMissingEnergySppdPriceEur
- DdMissingEnergySppdPriceEurVAT
- DdMissingEnergySppdUnit
- DdMissingEnergyUnit
- DdMissingEnergyViapAmount
- DdMissingEnergyViapAmountNoVAT
- DdMissingEnergyViapConsumptionAmount

- DdMissingEnergyViapIncludedVAT
- DdMissingEnergyViapPriceEur
- DdMissingEnergyViapPriceEurVAT
- DdMissingEnergyViapUnit
- DdPayingRecoveredEnergyAmount
- DdPayingRecoveredEnergyAmountNoVAT
- DdPayingRecoveredEnergyConsumptionAmount
- DdPayingRecoveredEnergyIncludedVAT
- DdPayingRecoveredEnergyPriceEur
- DdPayingRecoveredEnergyPriceEurVAT
- DdPayingRecoveredEnergyUnit
- DdPayingRecoveredMixedAmount
- DdPayingRecoveredMixedAmountNoVAT
- DdPayingRecoveredMixedConsumptionAmount
- DdPayingRecoveredMixedIncludedVAT
- DdPayingRecoveredMixedPriceEur
- DdPayingRecoveredMixedPriceEurVAT
- DdPayingRecoveredMixedUnit
- DdPayingRecoveredPercentConsumptionAmount
- DdPayingRecoveredPercentUnit
- DdPayingRecoveredPowerConsumptionAmount
- DdPayingRecoveredPowerUnit
- N1ConsumedElectricityConsumptionAmount
- N1ConsumedElectricityReadingsFrom
- N1ConsumedElectricityReadingsTo
- N1ConsumedElectricityUnit
- N1MissingEnergyAmount
- N1MissingEnergyAmountNoVAT
- N1MissingEnergyConsumptionAmount
- N1MissingEnergyIncludedVAT
- N1MissingEnergyPriceEur
- N1MissingEnergyPriceEurVAT
- N1MissingEnergySppdAmount
- N1MissingEnergySppdAmountNoVAT
- N1MissingEnergySppdConsumptionAmount
- N1MissingEnergySppdIncludedVAT
- N1MissingEnergySppdPriceEur
- N1MissingEnergySppdPriceEurVAT
- N1MissingEnergySppdUnit
- N1MissingEnergyUnit
- N1MissingEnergyViapAmount

- N1MissingEnergyViapAmountNoVAT
- N1MissingEnergyViapConsumptionAmount
- N1MissingEnergyViapIncludedVAT
- N1MissingEnergyViapPriceEur
- N1MissingEnergyViapPriceEurVAT
- N1MissingEnergyViapUnit
- N1PayingRecoveredEnergyAmount
- N1PayingRecoveredEnergyAmountNoVAT
- N1PayingRecoveredEnergyConsumptionAmount
- N1PayingRecoveredEnergyIncludedVAT
- N1PayingRecoveredEnergyPriceEur
- N1PayingRecoveredEnergyPriceEurVAT
- N1PayingRecoveredEnergyUnit
- N1PayingRecoveredMixedAmount
- N1PayingRecoveredMixedAmountNoVAT
- N1PayingRecoveredMixedConsumptionAmount
- N1PayingRecoveredMixedIncludedVAT
- N1PayingRecoveredMixedPriceEur
- N1PayingRecoveredMixedPriceEurVAT
- N1PayingRecoveredMixedUnit
- N1PayingRecoveredPercentConsumptionAmount
- N1PayingRecoveredPercentUnit
- N1PayingRecoveredPowerConsumptionAmount
- N1PayingRecoveredPowerUnit
- N2ConsumedElectricityConsumptionAmount
- N2ConsumedElectricityReadingsFrom
- N2ConsumedElectricityReadingsTo
- N2ConsumedElectricityUnit
- N2MissingEnergyAmount
- N2MissingEnergyAmountNoVAT
- N2MissingEnergyConsumptionAmount
- N2MissingEnergyIncludedVAT
- N2MissingEnergyPriceEur
- N2MissingEnergyPriceEurVAT
- N2MissingEnergySppdAmount
- N2MissingEnergySppdAmountNoVAT
- N2MissingEnergySppdConsumptionAmount
- N2MissingEnergySppdIncludedVAT
- N2MissingEnergySppdPriceEur
- N2MissingEnergySppdPriceEurVAT
- N2MissingEnergySppdUnit

- N2MissingEnergyUnit
- N2MissingEnergyViapAmount
- N2MissingEnergyViapAmountNoVAT
- N2MissingEnergyViapConsumptionAmount
- N2MissingEnergyViapIncludedVAT
- N2MissingEnergyViapPriceEur
- N2MissingEnergyViapPriceEurVAT
- N2MissingEnergyViapUnit
- N2PayingRecoveredEnergyAmount
- N2PayingRecoveredEnergyAmountNoVAT
- N2PayingRecoveredEnergyConsumptionAmount
- N2PayingRecoveredEnergyIncludedVAT
- N2PayingRecoveredEnergyPriceEur
- N2PayingRecoveredEnergyPriceEurVAT
- N2PayingRecoveredEnergyUnit
- N2PayingRecoveredMixedAmount
- N2PayingRecoveredMixedAmountNoVAT
- N2PayingRecoveredMixedConsumptionAmount
- N2PayingRecoveredMixedIncludedVAT
- N2PayingRecoveredMixedPriceEur
- N2PayingRecoveredMixedPriceEurVAT
- N2PayingRecoveredMixedUnit
- N2PayingRecoveredPercentConsumptionAmount
- N2PayingRecoveredPercentUnit
- N2PayingRecoveredPowerConsumptionAmount
- N2PayingRecoveredPowerUnit
- NkConsumedElectricityConsumptionAmount
- NkConsumedElectricityReadingsFrom
- NkConsumedElectricityReadingsTo
- NkConsumedElectricityUnit
- NkMissingEnergyAmount
- NkMissingEnergyAmountNoVAT
- NkMissingEnergyConsumptionAmount
- NkMissingEnergyIncludedVAT
- NkMissingEnergyPriceEur
- NkMissingEnergyPriceEurVAT
- NkMissingEnergySppdAmount
- NkMissingEnergySppdAmountNoVAT
- NkMissingEnergySppdConsumptionAmount
- NkMissingEnergySppdIncludedVAT
- NkMissingEnergySppdPriceEur

- NkMissingEnergySppdPriceEurVAT
- NkMissingEnergySppdUnit
- NkMissingEnergyUnit
- NkMissingEnergyViapAmount
- NkMissingEnergyViapAmountNoVAT
- NkMissingEnergyViapConsumptionAmount
- NkMissingEnergyViapIncludedVAT
- NkMissingEnergyViapPriceEur
- NkMissingEnergyViapPriceEurVAT
- NkMissingEnergyViapUnit
- NkPayingRecoveredEnergyAmount
- NkPayingRecoveredEnergyAmountNoVAT
- NkPayingRecoveredEnergyConsumptionAmount
- NkPayingRecoveredEnergyIncludedVAT
- NkPayingRecoveredEnergyPriceEur
- NkPayingRecoveredEnergyPriceEurVAT
- NkPayingRecoveredEnergyUnit
- NkPayingRecoveredMixedAmount
- NkPayingRecoveredMixedAmountNoVAT
- NkPayingRecoveredMixedConsumptionAmount
- NkPayingRecoveredMixedIncludedVAT
- NkPayingRecoveredMixedPriceEur
- NkPayingRecoveredMixedPriceEurVAT
- NkPayingRecoveredMixedUnit
- NkPayingRecoveredPercentConsumptionAmount
- NkPayingRecoveredPercentUnit
- NkPayingRecoveredPowerConsumptionAmount
- NkPayingRecoveredPowerUnit

Renamed fields (added Vk prefix):

- VkConsumedElectricityConsumptionAmount
- VkConsumedElectricityReadingsFrom
- VkConsumedElectricityReadingsTo
- VkConsumedElectricityUnit
- VkMissingEnergyAmount
- VkMissingEnergyAmountNoVAT
- VkMissingEnergyConsumptionAmount
- VkMissingEnergyDiscount
- VkMissingEnergyIncludedVAT

- VkMissingEnergyPriceEur
- VkMissingEnergyPriceEurVAT
- VkMissingEnergySppdAmount
- VkMissingEnergySppdAmountNoVAT
- VkMissingEnergySppdConsumptionAmount
- VkMissingEnergySppdDiscount
- VkMissingEnergySppdIncludedVAT
- VkMissingEnergySppdPriceEur
- VkMissingEnergySppdPriceEurVAT
- VkMissingEnergySppdUnit
- VkMissingEnergyUnit
- VkMissingEnergyViapAmount
- VkMissingEnergyViapAmountNoVAT
- VkMissingEnergyViapConsumptionAmount
- VkMissingEnergyViapDiscount
- VkMissingEnergyViapIncludedVAT
- VkMissingEnergyViapPriceEur
- VkMissingEnergyViapPriceEurVAT
- VkMissingEnergyViapUnit
- VkPayingRecoveredEnergyAmount
- VkPayingRecoveredEnergyAmountNoVAT
- VkPayingRecoveredEnergyConsumptionAmount
- VkPayingRecoveredEnergyDiscount
- VkPayingRecoveredEnergyIncludedVAT
- VkPayingRecoveredEnergyPriceEur
- VkPayingRecoveredEnergyPriceEurVAT
- VkPayingRecoveredEnergyUnit
- VkPayingRecoveredMixedAmount
- VkPayingRecoveredMixedAmountNoVAT
- VkPayingRecoveredMixedConsumptionAmount
- VkPayingRecoveredMixedDiscount
- VkPayingRecoveredMixedIncludedVAT
- VkPayingRecoveredMixedPriceEur
- VkPayingRecoveredMixedPriceEurVAT
- VkPayingRecoveredMixedUnit
- VkPayingRecoveredPercentConsumptionAmount
- VkPayingRecoveredPercentUnit
- VkPayingRecoveredPowerConsumptionAmount
- VkPayingRecoveredPowerUnit

0.6.16	2021-03-16	<p>Updated JSON specification of POST /reports/accounting-data-pack-b2b-meters-level method. Added new fields:</p> <ul style="list-style-type: none"> • DdConsumedElectricityConsumptionAmount • DdConsumedElectricityUnit • DdConsumedElectricityReadingsFrom • DdConsumedElectricityReadingsTo • NkConsumedElectricityConsumptionAmount • NkConsumedElectricityUnit • NkConsumedElectricityReadingsFrom • NkConsumedElectricityReadingsTo • MaConsumedElectricityConsumptionAmount • MaConsumedElectricityUnit • MaConsumedElectricityReadingsFrom • MaConsumedElectricityReadingsTo • VdConsumedElectricityConsumptionAmount • VdConsumedElectricityUnit • VdConsumedElectricityReadingsFrom • VdConsumedElectricityReadingsTo • SvConsumedElectricityConsumptionAmount • SvConsumedElectricityUnit • SvConsumedElectricityReadingsFrom • SvConsumedElectricityReadingsTo • MiConsumedElectricityConsumptionAmount • MiConsumedElectricityUnit • MiConsumedElectricityReadingsFrom • MiConsumedElectricityReadingsTo • DdPayingRecoveredEnergyConsumptionAmount • DdPayingRecoveredEnergyUnit • DdPayingRecoveredEnergyPriceEur • DdPayingRecoveredEnergyAmountNoVAT • NkPayingRecoveredEnergyConsumptionAmount • NkPayingRecoveredEnergyUnit • NkPayingRecoveredEnergyPriceEur • NkPayingRecoveredEnergyAmountNoVAT • MaPayingRecoveredEnergyConsumptionAmount • MaPayingRecoveredEnergyUnit • MaPayingRecoveredEnergyPriceEur • MaPayingRecoveredEnergyAmountNoVAT • VdPayingRecoveredEnergyConsumptionAmount • VdPayingRecoveredEnergyUnit
--------	------------	---

- VdPayingRecoveredEnergyPriceEur
- VdPayingRecoveredEnergyAmountNoVAT
- SvPayingRecoveredEnergyConsumptionAmount
- SvPayingRecoveredEnergyUnit
- SvPayingRecoveredEnergyPriceEur
- SvPayingRecoveredEnergyAmountNoVAT
- MiPayingRecoveredEnergyConsumptionAmount
- MiPayingRecoveredEnergyUnit
- MiPayingRecoveredEnergyPriceEur
- MiPayingRecoveredEnergyAmountNoVAT
- DdPayingRecoveredPercentConsumptionAmount
- DdPayingRecoveredPercentUnit
- NkPayingRecoveredPercentConsumptionAmount
- NkPayingRecoveredPercentUnit
- MaPayingRecoveredPercentConsumptionAmount
- MaPayingRecoveredPercentUnit
- VdPayingRecoveredPercentConsumptionAmount
- VdPayingRecoveredPercentUnit
- SvPayingRecoveredPercentConsumptionAmount
- SvPayingRecoveredPercentUnit
- MiPayingRecoveredPercentConsumptionAmount
- MiPayingRecoveredPercentUnit
- DdPayingRecoveredPowerConsumptionAmount
- DdPayingRecoveredPowerUnit
- NkPayingRecoveredPowerConsumptionAmount
- NkPayingRecoveredPowerUnit
- MaPayingRecoveredPowerConsumptionAmount
- MaPayingRecoveredPowerUnit
- VdPayingRecoveredPowerConsumptionAmount
- VdPayingRecoveredPowerUnit
- SvPayingRecoveredPowerConsumptionAmount
- SvPayingRecoveredPowerUnit
- MiPayingRecoveredPowerConsumptionAmount
- MiPayingRecoveredPowerUnit
- DdPayingRecoveredMixedConsumptionAmount
- DdPayingRecoveredMixedUnit
- DdPayingRecoveredMixedPriceEur
- DdPayingRecoveredMixedAmountNoVAT
- NkPayingRecoveredMixedConsumptionAmount
- NkPayingRecoveredMixedUnit
- NkPayingRecoveredMixedPriceEur

- NkPayingRecoveredMixedAmountNoVAT
- MaPayingRecoveredMixedConsumptionAmount
- MaPayingRecoveredMixedUnit
- MaPayingRecoveredMixedPriceEur
- MaPayingRecoveredMixedAmountNoVAT
- VdPayingRecoveredMixedConsumptionAmount
- VdPayingRecoveredMixedUnit
- VdPayingRecoveredMixedPriceEur
- VdPayingRecoveredMixedAmountNoVAT
- SvPayingRecoveredMixedConsumptionAmount
- SvPayingRecoveredMixedUnit
- SvPayingRecoveredMixedPriceEur
- SvPayingRecoveredMixedAmountNoVAT
- MiPayigRecoveredMixedConsumptionAmount
- MiPayingRecoveredMixedUnit
- MiPayingRecoveredMixedPriceEur
- MiPayingRecoveredMixedAmountNoVAT
- DdMissingEnergyConsumptionAmount
- DdMissingEnergyUnit
- DdMissingEnergyPriceEur
- DdMissingEnergyAmountNoVAT
- NkMissingEnergyConsumptionAmount
- NkMissingEnergyUnit
- NkMissingEnergyPriceEur
- NkMissingEnergyAmountNoVAT
- MaMissingEnergyConsumptionAmount
- MaMissingEnergyUnit
- MaMissingEnergyPriceEur
- MaMissingEnergyAmountNoVAT
- VdMissingEnergyConsumptionAmount
- VdMissingEnergyUnit
- VdMissingEnergyPriceEur
- VdMissingEnergyAmountNoVAT
- SvMissingEnergyConsumptionAmount
- SvMissingEnergyUnit
- SvMissingEnergyPriceEur
- SvMissingEnergyAmountNoVAT
- MiMissingEnergyConsumptionAmount
- MiMissingEnergyUnit
- MiMissingEnergyPriceEur
- MiMissingEnergyAmountNoVAT

- DdMissingEnergyViapConsumptionAmount
- DdMissingEnergyViapUnit
- DdMissingEnergyViapPriceEur
- DdMissingEnergyViapAmountNoVAT
- NkMissingEnergyViapConsumptionAmount
- NkMissingEnergyViapUnit
- NkMissingEnergyViapPriceEur
- NkMissingEnergyViapAmountNoVAT
- MaMissingEnergyViapConsumptionAmount
- MaMissingEnergyViapUnit
- MaMissingEnergyViapPriceEur
- MaMissingEnergyViapAmountNoVAT
- VdMissingEnergyViapConsumptionAmount
- VdMissingEnergyViapUnit
- VdMissingEnergyViapPriceEur
- VdMissingEnergyViapAmountNoVAT
- SvMissingEnergyViapConsumptionAmount
- SvMissingEnergyViapUnit
- SvMissingEnergyViapPriceEur
- SvMissingEnergyViapAmountNoVAT
- MiMissingEnergyViapConsumptionAmount
- MiMissingEnergyViapUnit
- MiMissingEnergyViapPriceEur
- MiMissingEnergyViapAmountNoVAT
- DdMissingEnergySppdConsumptionAmount
- DdMissingEnergySppdUnit
- DdMissingEnergySppdPriceEur
- DdMissingEnergySppdAmountNoVAT
- NkMissingEnergySppdConsumptionAmount
- NkMissingEnergySppdUnit
- NkMissingEnergySppdPriceEur
- NkMissingEnergySppdAmountNoVAT
- DdMissingEnergyDiscountConsumptionAmount
- DdMissingEnergyDiscountUnit
- DdMissingEnergyDiscountPriceEur
- DdMissingEnergyDiscountAmountNoVAT
- NkMissingEnergyDiscountConsumptionAmount
- NkMissingEnergyDiscountUnit
- NkMissingEnergyDiscountPriceEur
- NkMissingEnergyDiscountAmountNoVAT

Renamed fields (added Vk prefix):

- VkConsumedElectricityConsumptionAmount
- VkConsumedElectricityUnit
- VkConsumedElectricityReadingsFrom
- VkConsumedElectricityReadingsTo
- VkPayingRecoveredEnergyConsumptionAmount
- VkPayingRecoveredEnergyUnit
- VkPayingRecoveredEnergyPriceEur
- VkPayingRecoveredEnergyDiscount
- VkPayingRecoveredEnergyAmountNoVAT
- VkPayingRecoveredPercentConsumptionAmount
- VkPayingRecoveredPercentUnit
- VkPayingRecoveredPowerConsumptionAmount
- VkPayingRecoveredPowerUnit
- VkPayingRecoveredMixedConsumptionAmount
- VkPayingRecoveredMixedUnit
- VkPayingRecoveredMixedPriceEur
- VkPayingRecoveredMixedDiscount
- VkPayingRecoveredMixedAmountNoVAT
- VkMissingEnergyConsumptionAmount
- VkMissingEnergyUnit
- VkMissingEnergyPriceEur
- VkMissingEnergyDiscount
- VkMissingEnergyAmountNoVAT
- VkMissingEnergyViapConsumptionAmount
- VkMissingEnergyViapUnit
- VkMissingEnergyViapPriceEur
- VkMissingEnergyViapDiscount
- VkMissingEnergyViapAmountNoVAT
- VkMissingEnergySppdConsumptionAmount
- VkMissingEnergySppdUnit
- VkMissingEnergySppdPriceEur
- VkMissingEnergySppdDiscount
- VkMissingEnergySppdAmountNoVAT
- VkMissingEnergyDiscountConsumptionAmount
- VkMissingEnergyDiscountUnit
- VkMissingEnergyDiscountPriceEur
- VkMissingEnergyDiscountDiscount

		<ul style="list-style-type: none"> VkMissingEnergyDiscountAmountNoVAT
0.6.17	2021-03-17	<p>Supplemented 11 rule and 9 response error in:</p> <ul style="list-style-type: none"> POST /gateway/supplier/send-declaration-data
0.6.18	2021-03-22	<p>Added new method:</p> <ul style="list-style-type: none"> GET /gateway/supplier/v3/get-declaration-data?first={integer}&count={integer}&customerId={string}&objectNumber={string}
0.6.19	2021-03-23	<p>Added the new error message 44 and edited rule description 4</p> <ul style="list-style-type: none"> POST /supplier/v2/supplier-change-notifications (new)
0.6.20	2021-03-25	<p>Added the new 9 error message and a new 2 rule description</p> <ul style="list-style-type: none"> POST /data/data-orders
0.6.21	2021-04-06	<p>Added 423 rule and description in:</p> <ul style="list-style-type: none"> POST /reports/accounting-data-pack-b2c POST /reports/accounting-data-pack-b2c-count POST /reports/accounting-data-pack-b2b-meters-level POST /reports/accounting-data-pack-b2b-meters-level-count POST /reports/objects-data-pack POST /reports/objects-data-pack-count POST /reports/accounting-data-pack-b2b?first={integer}&count={integer} POST /reports/accounting-data-pack-b2b-count
0.6.22	2021-04-06	<p>(will be deployed in next sprint) Added the description of the first rule.</p> <ul style="list-style-type: none"> POST /gateway/supplier/send-declaration-data
0.6.23	2021-04-13	<p>Updated JSON specification of POST /reports/accounting-data-pack-b2c method and POST /reports/accounting-data-pack-b2b-meters-level method. Added new fields:</p> <ul style="list-style-type: none"> CompensatedConsumptionAmount

		<ul style="list-style-type: none"> ▪ OldIndependentSupplier
0.6.24	2021-04-21	<p>Updated JSON specification of POST /reports/accounting-data-pack-b2c method.</p> <p>Changed json fields ordering:</p> <ul style="list-style-type: none"> • CustomerID • ClientID • ClientName • ClientAddress • ObjectID • ObjectNumber • ObjectName • ObjectType • ObjectAddress • AgreementType • AgreementModel • AgreementFrom • AgreementTo • PermittablePowerConsumption • PermittablePowerGeneration • InstalledGeneratingPower • InstalledConsumptionPower • MetersAmount • AutoMetersAmount • ReportingPeriod • BillingPeriod • SupplyState • SupplyStateFrom • SupplyStateTo • MetersNumber • ReadingsSource • ReadingsReceiveDate • PaymentType • Service • DeclarationReferenceType • ReferenceSubmitDate • ReadingsSubmitDate • DeclarationReferenceNumber • UnaccountedConsumptionActNumber • UnaccountedConsumptionActCreateDate • UnaccountedConsumptionActFrom

		<ul style="list-style-type: none"> • UnaccountedConsumptionActTo • ConsumptionConversionActNumber • ConsumptionConversionActCreateDate • ConsumptionConversionActFrom • ConsumptionConversionActTo • ConsumptionState • ConsumptionStateFrom • ConsumptionStateTo • TariffPlan • TariffPlanChangeDate • ConsumptionConversionAct • PowerPlantCapacityDateFrom • EnergyObtainedDateFrom • PowerPlantCapacityDateTo • EnergyObtainedDateTo • EnergyObtainedPowerKw • OperatorGridElectricityPercent • ClientGridElectricityPercent • VkConsumptionAmount • VkViapConsumptionAmount • VkSppdConsumptionAmount • DdConsumptionAmount • DdViapConsumptionAmount • DdSppdConsumptionAmount • NkConsumptionAmount • NkViapConsumptionAmount • NkSppdConsumptionAmount • N2ConsumptionAmount • N2ViapConsumptionAmount • N2SppdConsumptionAmount • D1ConsumptionAmount • D1ViapConsumptionAmount • D1SppdConsumptionAmount • D2ConsumptionAmount • D2ViapConsumptionAmount • D2SppdConsumptionAmount • N1ConsumptionAmount • N1ViapConsumptionAmount • N1SppdConsumptionAmount • VkConsumedElectricityConsumptionAmount • DdConsumedElectricityConsumptionAmount
--	--	---

- NkConsumedElectricityConsumptionAmount
- N2ConsumedElectricityConsumptionAmount
- D1ConsumedElectricityConsumptionAmount
- D2ConsumedElectricityConsumptionAmount
- N1ConsumedElectricityConsumptionAmount
- VkPayingRecoveredEnergyConsumptionAmount
- DdPayingRecoveredEnergyConsumptionAmount
- NkPayingRecoveredEnergyConsumptionAmount
- N2PayingRecoveredEnergyConsumptionAmount
- D1PayingRecoveredEnergyConsumptionAmount
- D2PayingRecoveredEnergyConsumptionAmount
- N1PayingRecoveredEnergyConsumptionAmount
- VkPayingRecoveredPercentConsumptionAmount
- DdPayingRecoveredPercentConsumptionAmount
- NkPayingRecoveredPercentConsumptionAmount
- N2PayingRecoveredPercentConsumptionAmount
- D1PayingRecoveredPercentConsumptionAmount
- D2PayingRecoveredPercentConsumptionAmount
- N1PayingRecoveredPercentConsumptionAmount
- VkPayingRecoveredPowerConsumptionAmount
- DdPayingRecoveredPowerConsumptionAmount
- NkPayingRecoveredPowerConsumptionAmount
- N2PayingRecoveredPowerConsumptionAmount
- D1PayingRecoveredPowerConsumptionAmount
- D2PayingRecoveredPowerConsumptionAmount
- N1PayingRecoveredPowerConsumptionAmount
- VkPayingRecoveredMixedConsumptionAmount
- DdPayingRecoveredMixedConsumptionAmount
- NkPayingRecoveredMixedConsumptionAmount
- N2PayingRecoveredMixedConsumptionAmount
- D1PayingRecoveredMixedConsumptionAmount
- D2PayingRecoveredMixedConsumptionAmount
- N1PayingRecoveredMixedConsumptionAmount
- VkMissingEnergyConsumptionAmount
- VkMissingEnergyViapConsumptionAmount
- VkMissingEnergySppdConsumptionAmount
- DdMissingEnergyConsumptionAmount
- DdMissingEnergyViapConsumptionAmount
- DdMissingEnergySppdConsumptionAmount
- NkMissingEnergyConsumptionAmount
- NkMissingEnergyViapConsumptionAmount

- NkMissingEnergySppdConsumptionAmount
- N2MissingEnergyConsumptionAmount
- N2MissingEnergyViapConsumptionAmount
- N2MissingEnergySppdConsumptionAmount
- D1MissingEnergyConsumptionAmount
- D1MissingEnergyViapConsumptionAmount
- D1MissingEnergySppdConsumptionAmount
- D2MissingEnergyConsumptionAmount
- D2MissingEnergyViapConsumptionAmount
- D2MissingEnergySppdConsumptionAmount
- N1MissingEnergyConsumptionAmount
- N1MissingEnergyViapConsumptionAmount
- N1MissingEnergySppdConsumptionAmount
- GridSuppliedConsumptionAmount
- AccumulatedBeginningConsumptionAmount
- AccumulatedEndConsumptionAmount
- AccumulatedTransferredConsumptionAmount
- AccumulatedUploadedConsumptionAmount
- AccumulatedRaisedConsumptionAmount
- CompensatedConsumptionAmount
- OldIndependentSupplier
- PowerPlantCapacityConsumptionAmount
- EnergyObtainedConsumptionAmount
- OperatorGridElectricityConsumptionAmount
- ClientGridElectricityConsumptionAmount
- VkUnit
- VkViapUnit
- VkSppdUnit
- DdUnit
- DdViapUnit
- DdSppdUnit
- NkUnit
- NkViapUnit
- NkSppdUnit
- N2Unit
- N2ViapUnit
- N2SppdUnit
- D1Unit
- D1ViapUnit
- D1SppdUnit
- D2Unit

- D2ViapUnit
- D2SppdUnit
- N1Unit
- N1ViapUnit
- N1SppdUnit
- VkConsumedElectricityUnit
- DdConsumedElectricityUnit
- NkConsumedElectricityUnit
- N2ConsumedElectricityUnit
- D1ConsumedElectricityUnit
- D2ConsumedElectricityUnit
- N1ConsumedElectricityUnit
- VkPayingRecoveredEnergyUnit
- DdPayingRecoveredEnergyUnit
- NkPayingRecoveredEnergyUnit
- N2PayingRecoveredEnergyUnit
- D1PayingRecoveredEnergyUnit
- D2PayingRecoveredEnergyUnit
- N1PayingRecoveredEnergyUnit
- VkPayingRecoveredPercentUnit
- DdPayingRecoveredPercentUnit
- NkPayingRecoveredPercentUnit
- N2PayingRecoveredPercentUnit
- D1PayingRecoveredPercentUnit
- D2PayingRecoveredPercentUnit
- N1PayingRecoveredPercentUnit
- VkPayingRecoveredPowerUnit
- DdPayingRecoveredPowerUnit
- NkPayingRecoveredPowerUnit
- N2PayingRecoveredPowerUnit
- D1PayingRecoveredPowerUnit
- D2PayingRecoveredPowerUnit
- N1PayingRecoveredPowerUnit
- VkPayingRecoveredMixedUnit
- DdPayingRecoveredMixedUnit
- NkPayingRecoveredMixedUnit
- N2PayingRecoveredMixedUnit
- D1PayingRecoveredMixedUnit
- D2PayingRecoveredMixedUnit
- N1PayingRecoveredMixedUnit
- VkMissingEnergyUnit

- VkMissingEnergyViapUnit
- VkMissingEnergySppdUnit
- DdMissingEnergyUnit
- DdMissingEnergyViapUnit
- DdMissingEnergySppdUnit
- NkMissingEnergyUnit
- NkMissingEnergyViapUnit
- NkMissingEnergySppdUnit
- N2MissingEnergyUnit
- N2MissingEnergyViapUnit
- N2MissingEnergySppdUnit
- D1MissingEnergyUnit
- D1MissingEnergyViapUnit
- D1MissingEnergySppdUnit
- D2MissingEnergyUnit
- D2MissingEnergyViapUnit
- D2MissingEnergySppdUnit
- N1MissingEnergyUnit
- N1MissingEnergyViapUnit
- N1MissingEnergySppdUnit
- VkReadingsFrom
- DdReadingsFrom
- NkReadingsFrom
- N2ReadingsFrom
- D1ReadingsFrom
- D2ReadingsFrom
- N1ReadingsFrom
- VkConsumedElectricityReadingsFrom
- DdConsumedElectricityReadingsFrom
- NkConsumedElectricityReadingsFrom
- N2ConsumedElectricityReadingsFrom
- D1ConsumedElectricityReadingsFrom
- D2ConsumedElectricityReadingsFrom
- N1ConsumedElectricityReadingsFrom
- GridSuppliedReadingsFrom
- VkReadingsTo
- DdReadingsTo
- NkReadingsTo
- N2ReadingsTo
- D1ReadingsTo
- D2ReadingsTo

- N1ReadingsTo
- VkConsumedElectricityReadingsTo
- DdConsumedElectricityReadingsTo
- NkConsumedElectricityReadingsTo
- N2ConsumedElectricityReadingsTo
- D1ConsumedElectricityReadingsTo
- D2ConsumedElectricityReadingsTo
- N1ConsumedElectricityReadingsTo
- GridSuppliedReadingsTo
- VkPriceEur
- VkViapPriceEur
- VkSppdPriceEur
- DdPriceEur
- DdViapPriceEur
- DdSppdPriceEur
- NkPriceEur
- NkViapPriceEur
- NkSppdPriceEur
- N2PriceEur
- N2ViapPriceEur
- N2SppdPriceEur
- D1PriceEur
- D1ViapPriceEur
- D1SppdPriceEur
- D2PriceEur
- D2ViapPriceEur
- D2SppdPriceEur
- N1PriceEur
- N1ViapPriceEur
- N1SppdPriceEur
- VkPayingRecoveredEnergyPriceEur
- DdPayingRecoveredEnergyPriceEur
- NkPayingRecoveredEnergyPriceEur
- N2PayingRecoveredEnergyPriceEur
- D1PayingRecoveredEnergyPriceEur
- D2PayingRecoveredEnergyPriceEur
- N1PayingRecoveredEnergyPriceEur
- VkPayingRecoveredMixedPriceEur
- DdPayingRecoveredMixedPriceEur
- NkPayingRecoveredMixedPriceEur
- N2PayingRecoveredMixedPriceEur

- D1PayingRecoveredMixedPriceEur
- D2PayingRecoveredMixedPriceEur
- N1PayingRecoveredMixedPriceEur
- VkMissingEnergyPriceEur
- VkMissingEnergyViapPriceEur
- VkMissingEnergySppdPriceEur
- DdMissingEnergyPriceEur
- DdMissingEnergyViapPriceEur
- DdMissingEnergySppdPriceEur
- NkMissingEnergyPriceEur
- NkMissingEnergyViapPriceEur
- NkMissingEnergySppdPriceEur
- N2MissingEnergyPriceEur
- N2MissingEnergyViapPriceEur
- N2MissingEnergySppdPriceEur
- D1MissingEnergyPriceEur
- D1MissingEnergyViapPriceEur
- D1MissingEnergySppdPriceEur
- D2MissingEnergyPriceEur
- D2MissingEnergyViapPriceEur
- D2MissingEnergySppdPriceEur
- N1MissingEnergyPriceEur
- N1MissingEnergyViapPriceEur
- N1MissingEnergySppdPriceEur
- PowerPlantCapacityPriceEur
- VkPriceEurVAT
- VkViapPriceEurVAT
- VkSppdPriceEurVAT
- DdPriceEurVAT
- DdViapPriceEurVAT
- DdSppdPriceEurVAT
- NkPriceEurVAT
- NkViapPriceEurVAT
- NkSppdPriceEurVAT
- N2PriceEurVAT
- N2ViapPriceEurVAT
- N2SppdPriceEurVAT
- D1PriceEurVAT
- D1ViapPriceEurVAT
- D1SppdPriceEurVAT
- D2PriceEurVAT

- D2ViapPriceEurVAT
- D2SppdPriceEurVAT
- N1PriceEurVAT
- N1ViapPriceEurVAT
- N1SppdPriceEurVAT
- VkPayingRecoveredEnergyPriceEurVAT
- DdPayingRecoveredEnergyPriceEurVAT
- NkPayingRecoveredEnergyPriceEurVAT
- N2PayingRecoveredEnergyPriceEurVAT
- D1PayingRecoveredEnergyPriceEurVAT
- D2PayingRecoveredEnergyPriceEurVAT
- N1PayingRecoveredEnergyPriceEurVAT
- VkPayingRecoveredMixedPriceEurVAT
- DdPayingRecoveredMixedPriceEurVAT
- NkPayingRecoveredMixedPriceEurVAT
- N2PayingRecoveredMixedPriceEurVAT
- D1PayingRecoveredMixedPriceEurVAT
- D2PayingRecoveredMixedPriceEurVAT
- N1PayingRecoveredMixedPriceEurVAT
- VkMissingEnergyPriceEurVAT
- VkMissingEnergyViapPriceEurVAT
- VkMissingEnergySppdPriceEurVAT
- DdMissingEnergyPriceEurVAT
- DdMissingEnergyViapPriceEurVAT
- DdMissingEnergySppdPriceEurVAT
- NkMissingEnergyPriceEurVAT
- NkMissingEnergyViapPriceEurVAT
- NkMissingEnergySppdPriceEurVAT
- N2MissingEnergyPriceEurVAT
- N2MissingEnergyViapPriceEurVAT
- N2MissingEnergySppdPriceEurVAT
- D1MissingEnergyPriceEurVAT
- D1MissingEnergyViapPriceEurVAT
- D1MissingEnergySppdPriceEurVAT
- D2MissingEnergyPriceEurVAT
- D2MissingEnergyViapPriceEurVAT
- D2MissingEnergySppdPriceEurVAT
- N1MissingEnergyPriceEurVAT
- N1MissingEnergyViapPriceEurVAT
- N1MissingEnergySppdPriceEurVAT
- PowerPlantCapacityPriceEurVat

- VkDiscount
- VkViapDiscount
- VkSppdDiscount
- DdDiscount
- DdViapDiscount
- DdSppdDiscount
- NkDiscount
- NkViapDiscount
- NkSppdDiscount
- N2Discount
- N2ViapDiscount
- N2SppdDiscount
- D1Discount
- D1ViapDiscount
- D1SppdDiscount
- D2Discount
- D2ViapDiscount
- D2SppdDiscount
- N1Discount
- N1ViapDiscount
- N1SppdDiscount
- VkPayingRecoveredEnergyDiscount
- VkPayingRecoveredMixedDiscount
- VkMissingEnergyDiscount
- VkMissingEnergyViapDiscount
- VkMissingEnergySppdDiscount
- FixedFeeAmountNoVAT
- VkAmountNoVAT
- VkViapAmountNoVAT
- VkSppdAmountNoVAT
- DdAmountNoVAT
- DdViapAmountNoVAT
- DdSppdAmountNoVAT
- NkAmountNoVAT
- NkViapAmountNoVAT
- NkSppdAmountNoVAT
- N2AmountNoVAT
- N2ViapAmountNoVAT
- N2SppdAmountNoVAT
- D1AmountNoVAT
- D1ViapAmountNoVAT

- D1SppdAmountNoVAT
- D2AmountNoVAT
- D2ViapAmountNoVAT
- D2SppdAmountNoVAT
- N1AmountNoVAT
- N1ViapAmountNoVAT
- N1SppdAmountNoVAT
- VkPayingRecoveredEnergyAmountNoVAT
- DdPayingRecoveredEnergyAmountNoVAT
- NkPayingRecoveredEnergyAmountNoVAT
- N2PayingRecoveredEnergyAmountNoVAT
- D1PayingRecoveredEnergyAmountNoVAT
- D2PayingRecoveredEnergyAmountNoVAT
- N1PayingRecoveredEnergyAmountNoVAT
- VkPayingRecoveredMixedAmountNoVAT
- DdPayingRecoveredMixedAmountNoVAT
- NkPayingRecoveredMixedAmountNoVAT
- N2PayingRecoveredMixedAmountNoVAT
- D1PayingRecoveredMixedAmountNoVAT
- D2PayingRecoveredMixedAmountNoVAT
- N1PayingRecoveredMixedAmountNoVAT
- VkMissingEnergyAmountNoVAT
- VkMissingEnergyViapAmountNoVAT
- VkMissingEnergySppdAmountNoVAT
- DdMissingEnergyAmountNoVAT
- DdMissingEnergyViapAmountNoVAT
- DdMissingEnergySppdAmountNoVAT
- NkMissingEnergyAmountNoVAT
- NkMissingEnergyViapAmountNoVAT
- NkMissingEnergySppdAmountNoVAT
- N2MissingEnergyAmountNoVAT
- N2MissingEnergyViapAmountNoVAT
- N2MissingEnergySppdAmountNoVAT
- D1MissingEnergyAmountNoVAT
- D1MissingEnergyViapAmountNoVAT
- D1MissingEnergySppdAmountNoVAT
- D2MissingEnergyAmountNoVAT
- D2MissingEnergyViapAmountNoVAT
- D2MissingEnergySppdAmountNoVAT
- N1MissingEnergyAmountNoVAT
- N1MissingEnergyViapAmountNoVAT

- N1MissingEnergySppdAmountNoVAT
- PowerPlantCapacityAmountNoVAT
- FixedFeeAmount
- VkAmount
- VkViapAmount
- VkSppdAmount
- DdAmount
- DdViapAmount
- DdSppdAmount
- NkAmount
- NkViapAmount
- NkSppdAmount
- N2Amount
- N2ViapAmount
- N2SppdAmount
- D1Amount
- D1ViapAmount
- D1SppdAmount
- D2Amount
- D2ViapAmount
- D2SppdAmount
- N1Amount
- N1ViapAmount
- N1SppdAmount
- VkPayingRecoveredEnergyAmount
- DdPayingRecoveredEnergyAmount
- NkPayingRecoveredEnergyAmount
- N2PayingRecoveredEnergyAmount
- D1PayingRecoveredEnergyAmount
- D2PayingRecoveredEnergyAmount
- N1PayingRecoveredEnergyAmount
- VkPayingRecoveredMixedAmount
- DdPayingRecoveredMixedAmount
- NkPayingRecoveredMixedAmount
- N2PayingRecoveredMixedAmount
- D1PayingRecoveredMixedAmount
- D2PayingRecoveredMixedAmount
- N1PayingRecoveredMixedAmount
- VkMissingEnergyAmount
- VkMissingEnergyViapAmount
- VkMissingEnergySppdAmount

- DdMissingEnergyAmount
- DdMissingEnergyViapAmount
- DdMissingEnergySppdAmount
- NkMissingEnergyAmount
- NkMissingEnergyViapAmount
- NkMissingEnergySppdAmount
- N2MissingEnergyAmount
- N2MissingEnergyViapAmount
- N2MissingEnergySppdAmount
- D1MissingEnergyAmount
- D1MissingEnergyViapAmount
- D1MissingEnergySppdAmount
- D2MissingEnergyAmount
- D2MissingEnergyViapAmount
- D2MissingEnergySppdAmount
- N1MissingEnergyAmount
- N1MissingEnergyViapAmount
- N1MissingEnergySppdAmount
- PowerPlantCapacityAmount
- FixedFeeIncludedVAT
- VkIncludedVAT
- VkViapIncludedVAT
- VkSppdIncludedVAT
- DdIncludedVAT
- DdViapIncludedVAT
- DdSppdIncludedVAT
- NkIncludedVAT
- NkViapIncludedVAT
- NkSppdIncludedVAT
- N2IncludedVAT
- N2ViapIncludedVAT
- N2SppdIncludedVAT
- D1IncludedVAT
- D1ViapIncludedVAT
- D1SppdIncludedVAT
- D2IncludedVAT
- D2ViapIncludedVAT
- D2SppdIncludedVAT
- N1IncludedVAT
- N1ViapIncludedVAT
- N1SppdIncludedVAT

		<ul style="list-style-type: none"> • VkPayingRecoveredEnergyIncludedVAT • DdPayingRecoveredEnergyIncludedVAT • NkPayingRecoveredEnergyIncludedVAT • N2PayingRecoveredEnergyIncludedVAT • D1PayingRecoveredEnergyIncludedVAT • D2PayingRecoveredEnergyIncludedVAT • N1PayingRecoveredEnergyIncludedVAT • VkPayingRecoveredMixedIncludedVAT • DdPayingRecoveredMixedIncludedVAT • NkPayingRecoveredMixedIncludedVAT • N2PayingRecoveredMixedIncludedVAT • D1PayingRecoveredMixedIncludedVAT • D2PayingRecoveredMixedIncludedVAT • N1PayingRecoveredMixedIncludedVAT • VkMissingEnergyIncludedVAT • VkMissingEnergyViapIncludedVAT • VkMissingEnergySppdIncludedVAT • DdMissingEnergyIncludedVAT • DdMissingEnergyViapIncludedVAT • DdMissingEnergySppdIncludedVAT • NkMissingEnergyIncludedVAT • NkMissingEnergyViapIncludedVAT • NkMissingEnergySppdIncludedVAT • N2MissingEnergyIncludedVAT • N2MissingEnergyViapIncludedVAT • N2MissingEnergySppdIncludedVAT • D1MissingEnergyIncludedVAT • D1MissingEnergyViapIncludedVAT • D1MissingEnergySppdIncludedVAT • D2MissingEnergyIncludedVAT • D2MissingEnergyViapIncludedVAT • D2MissingEnergySppdIncludedVAT • N1MissingEnergyIncludedVAT • N1MissingEnergyViapIncludedVAT • N1MissingEnergySppdIncludedVAT • PowerPlantCapacityIncludedVAT • PowerPlantCapacityUnit
0.6.25	2021-04-21	Updated JSON specification of POST /reports/accounting-data-pack-b2b-meters-level method. Changed json fields ordering:

- CustomerID
- ClientID
- ClientName
- ClientAddress
- ObjectID
- ObjectNumber
- ObjectName
- ObjectType
- ObjectAddress
- AgreementType
- AgreementModel
- AgreementFrom
- AgreementTo
- PermittablePowerConsumption
- PermittablePowerGeneration
- InstalledGeneratingPower
- InstalledConsumptionPower
- MetersAmount
- AutoMetersAmount
- ReportingPeriod
- BillingPeriod
- SupplyState
- SupplyStateFrom
- SupplyStateTo
- MetersNumber
- ReadingsSource
- ReadingsReceiveDate
- PaymentType
- DeclarationReferenceType
- Service
- ReferenceSubmitDate
- ReadingsSubmitDate
- DeclarationReferenceNumber
- UnaccountedConsumptionActNumber
- UnaccountedConsumptionActCreateDate
- UnaccountedConsumptionActFrom
- UnaccountedConsumptionActTo
- ConsumptionConversionActNumber
- ConsumptionConversionActCreateDate
- ConsumptionConversionActFrom
- ConsumptionConversionActTo

- ConsumptionState
- ConsumptionStateFrom
- ConsumptionStateTo
- TariffPlan
- PowerPlantCapacityDateFrom
- EnergyObtainedDateFrom
- PowerPlantCapacityDateTo
- PowerPlantCapacitySource
- PowerPlantCapacitySourceDateFrom
- PowerPlantCapacitySourceDateTo
- EnergyObtainedDateTo
- EnergyObtainedPowerKw
- TariffPlanChangeDate
- ConsumptionConversionAct
- UnaccountedAct
- ConversionAct
- OperatorGridElectricityPercent
- ClientGridElectricityPercent
- GaConsumptionAmount
- VkConsumptionAmount
- VkViapConsumptionAmount
- VkSppdConsumptionAmount
- VkDiscountConsumptionAmount
- DdConsumptionAmount
- DdViapConsumptionAmount
- DdSppdConsumptionAmount
- DdDiscountConsumptionAmount
- NkConsumptionAmount
- NkViapConsumptionAmount
- NkSppdConsumptionAmount
- NkDiscountConsumptionAmount
- MaConsumptionAmount
- MaViapConsumptionAmount
- VdConsumptionAmount
- VdViapConsumptionAmount
- SvConsumptionAmount
- SvViapConsumptionAmount
- MiConsumptionAmount
- MiViapConsumptionAmount
- RvConsumptionAmount
- RgConsumptionAmount

- VgConsumptionAmount
- Reliability1ConsumptionAmount
- Reliability2ConsumptionAmount
- Reliability3ConsumptionAmount
- TechnologicalCostsViapConsumptionAmount
- TechnologicalCostsConsumptionAmount
- GeneralInterestConsumptionAmount
- VkConsumedElectricityConsumptionAmount
- DdConsumedElectricityConsumptionAmount
- NkConsumedElectricityConsumptionAmount
- MaConsumedElectricityConsumptionAmount
- VdConsumedElectricityConsumptionAmount
- SvConsumedElectricityConsumptionAmount
- MiConsumedElectricityConsumptionAmount
- VkPayingRecoveredEnergyConsumptionAmount
- DdPayingRecoveredEnergyConsumptionAmount
- NkPayingRecoveredEnergyConsumptionAmount
- MaPayingRecoveredEnergyConsumptionAmount
- VdPayingRecoveredEnergyConsumptionAmount
- SvPayingRecoveredEnergyConsumptionAmount
- MiPayingRecoveredEnergyConsumptionAmount
- VkPayingRecoveredPercentConsumptionAmount
- DdPayingRecoveredPercentConsumptionAmount
- NkPayingRecoveredPercentConsumptionAmount
- MaPayingRecoveredPercentConsumptionAmount
- VdPayingRecoveredPercentConsumptionAmount
- SvPayingRecoveredPercentConsumptionAmount
- MiPayingRecoveredPercentConsumptionAmount
- VkPayingRecoveredPowerConsumptionAmount
- DdPayingRecoveredPowerConsumptionAmount
- NkPayingRecoveredPowerConsumptionAmount
- MaPayingRecoveredPowerConsumptionAmount
- VdPayingRecoveredPowerConsumptionAmount
- SvPayingRecoveredPowerConsumptionAmount
- MiPayingRecoveredPowerConsumptionAmount
- VkPayingRecoveredMixedConsumptionAmount
- DdPayingRecoveredMixedConsumptionAmount
- NkPayingRecoveredMixedConsumptionAmount
- MaPayingRecoveredMixedConsumptionAmount
- VdPayingRecoveredMixedConsumptionAmount
- SvPayingRecoveredMixedConsumptionAmount

		<ul style="list-style-type: none"> • MiPayingRecoveredMixedConsumptionAmount • VkMissingEnergyConsumptionAmount • VkMissingEnergyViapConsumptionAmount • VkMissingEnergySppdConsumptionAmount • DdMissingEnergyConsumptionAmount • DdMissingEnergyViapConsumptionAmount • DdMissingEnergySppdConsumptionAmount • NkMissingEnergyConsumptionAmount • NkMissingEnergyViapConsumptionAmount • NkMissingEnergySppdConsumptionAmount • MaMissingEnergyConsumptionAmount • MaMissingEnergyViapConsumptionAmount • VdMissingEnergyConsumptionAmount • VdMissingEnergyViapConsumptionAmount • SvMissingEnergyConsumptionAmount • SvMissingEnergyViapConsumptionAmount • MiMissingEnergyConsumptionAmount • MiMissingEnergyViapConsumptionAmount • VkMissingEnergyDiscountConsumptionAmount • DdMissingEnergyDiscountConsumptionAmount • NkMissingEnergyDiscountConsumptionAmount • GridSuppliedConsumptionAmount • AccumulatedBeginningConsumptionAmount • AccumulatedEndConsumptionAmount • AccumulatedTransferredConsumptionAmount • AccumulatedUploadedConsumptionAmount • AccumulatedRaisedConsumptionAmount • CompensatedConsumptionAmount • OldIndependentSupplier • PowerPlantCapacityConsumptionAmount • EnergyObtainedConsumptionAmount • OperatorGridElectricityConsumptionAmount • ClientGridElectricityConsumptionAmount • PowerPlantCapacityUnit • GaUnit • VkUnit • VkViapUnit • VkSppdUnit • VkDiscountUnit • DdUnit • DdViapUnit
--	--	---

- DdSppdUnit
- DdDiscountUnit
- NkUnit
- NkViapUnit
- NkSppdUnit
- NkDiscountUnit
- MaUnit
- MaViapUnit
- VdUnit
- VdViapUnit
- SvUnit
- SvViapUnit
- MiUnit
- MiViapUnit
- RvUnit
- RgUnit
- VgUnit
- Reliability1Unit
- Reliability2Unit
- Reliability3Unit
- TechnologicalCostsViapUnit
- TechnologicalCostsUnit
- GeneralInterestUnit
- VkConsumedElectricityUnit
- DdConsumedElectricityUnit
- NkConsumedElectricityUnit
- MaConsumedElectricityUnit
- VdConsumedElectricityUnit
- SvConsumedElectricityUnit
- MiConsumedElectricityUnit
- VkPayingRecoveredEnergyUnit
- DdPayingRecoveredEnergyUnit
- NkPayingRecoveredEnergyUnit
- MaPayingRecoveredEnergyUnit
- VdPayingRecoveredEnergyUnit
- SvPayingRecoveredEnergyUnit
- MiPayingRecoveredEnergyUnit
- VkPayingRecoveredPercentUnit
- DdPayingRecoveredPercentUnit
- NkPayingRecoveredPercentUnit
- MaPayingRecoveredPercentUnit

- VdPayingRecoveredPercentUnit
- SvPayingRecoveredPercentUnit
- MiPayingRecoveredPercentUnit
- VkPayingRecoveredPowerUnit
- DdPayingRecoveredPowerUnit
- NkPayingRecoveredPowerUnit
- MaPayingRecoveredPowerUnit
- VdPayingRecoveredPowerUnit
- SvPayingRecoveredPowerUnit
- MiPayingRecoveredPowerUnit
- VkPayingRecoveredMixedUnit
- DdPayingRecoveredMixedUnit
- NkPayingRecoveredMixedUnit
- MaPayingRecoveredMixedUnit
- VdPayingRecoveredMixedUnit
- SvPayingRecoveredMixedUnit
- MiPayingRecoveredMixedUnit
- VkMissingEnergyUnit
- VkMissingEnergyViapUnit
- VkMissingEnergySppdUnit
- DdMissingEnergyUnit
- DdMissingEnergyViapUnit
- DdMissingEnergySppdUnit
- NkMissingEnergyUnit
- NkMissingEnergyViapUnit
- NkMissingEnergySppdUnit
- MaMissingEnergyUnit
- MaMissingEnergyViapUnit
- VdMissingEnergyUnit
- VdMissingEnergyViapUnit
- SvMissingEnergyUnit
- SvMissingEnergyViapUnit
- MiMissingEnergyUnit
- MiMissingEnergyViapUnit
- VkMissingEnergyDiscountUnit
- DdMissingEnergyDiscountUnit
- NkMissingEnergyDiscountUnit
- VkReadingsFrom
- DdReadingsFrom
- NkReadingsFrom
- MaReadingsFrom

- VdReadingsFrom
- SvReadingsFrom
- MiReadingsFrom
- RvReadingsFrom
- RgReadingsFrom
- VkConsumedElectricityReadingsFrom
- DdConsumedElectricityReadingsFrom
- NkConsumedElectricityReadingsFrom
- MaConsumedElectricityReadingsFrom
- VdConsumedElectricityReadingsFrom
- SvConsumedElectricityReadingsFrom
- MiConsumedElectricityReadingsFrom
- GridSuppliedReadingsFrom
- VkReadingsTo
- DdReadingsTo
- NkReadingsTo
- MaReadingsTo
- VdReadingsTo
- SvReadingsTo
- MiReadingsTo
- RvReadingsTo
- RgReadingsTo
- VkConsumedElectricityReadingsTo
- DdConsumedElectricityReadingsTo
- NkConsumedElectricityReadingsTo
- MaConsumedElectricityReadingsTo
- VdConsumedElectricityReadingsTo
- SvConsumedElectricityReadingsTo
- MiConsumedElectricityReadingsTo
- GridSuppliedReadingsTo
- GaPriceEur
- VkPriceEur
- VkViapPriceEur
- VkSppdPriceEur
- VkDiscountPriceEur
- DdPriceEur
- DdViapPriceEur
- DdSppdPriceEur
- DdDiscountPriceEur
- NkPriceEur
- NkViapPriceEur

- NkSpdpPriceEur
- NkDiscountPriceEur
- MaPriceEur
- MaViapPriceEur
- VdPriceEur
- VdViapPriceEur
- SvPriceEur
- SvViapPriceEur
- MiPriceEur
- MiViapPriceEur
- RvPriceEur
- RgPriceEur
- VgPriceEur
- Reliability1PriceEur
- Reliability2PriceEur
- Reliability3PriceEur
- TechnologicalCostsViapPriceEur
- TechnologicalCostsPriceEur
- GeneralInterestPriceEur
- VkPayingRecoveredEnergyPriceEur
- DdPayingRecoveredEnergyPriceEur
- NkPayingRecoveredEnergyPriceEur
- MaPayingRecoveredEnergyPriceEur
- VdPayingRecoveredEnergyPriceEur
- SvPayingRecoveredEnergyPriceEur
- MiPayingRecoveredEnergyPriceEur
- VkPayingRecoveredMixedPriceEur
- DdPayingRecoveredMixedPriceEur
- NkPayingRecoveredMixedPriceEur
- MaPayingRecoveredMixedPriceEur
- VdPayingRecoveredMixedPriceEur
- SvPayingRecoveredMixedPriceEur
- MiPayingRecoveredMixedPriceEur
- VkMissingEnergyPriceEur
- VkMissingEnergyViapPriceEur
- VkMissingEnergySpdpPriceEur
- DdMissingEnergyPriceEur
- DdMissingEnergyViapPriceEur
- DdMissingEnergySpdpPriceEur
- NkMissingEnergyPriceEur
- NkMissingEnergyViapPriceEur

- NkMissingEnergySppdPriceEur
- MaMissingEnergyPriceEur
- MaMissingEnergyViapPriceEur
- VdMissingEnergyPriceEur
- VdMissingEnergyViapPriceEur
- SvMissingEnergyPriceEur
- SvMissingEnergyViapPriceEur
- MiMissingEnergyPriceEur
- MiMissingEnergyViapPriceEur
- VkMissingEnergyDiscountPriceEur
- DdMissingEnergyDiscountPriceEur
- NkMissingEnergyDiscountPriceEur
- PowerPlantCapacityPriceEur
- GaDiscount
- VkDiscount
- VkViapDiscount
- VkSppdDiscount
- VkDiscountDiscount
- DdDiscount
- DdViapDiscount
- DdSppdDiscount
- DdDiscountDiscount
- NkDiscount
- NkViapDiscount
- NkSppdDiscount
- NkDiscountDiscount
- MaDiscount
- MaViapDiscount
- VdDiscount
- VdViapDiscount
- SvDiscount
- SvViapDiscount
- MiDiscount
- MiViapDiscount
- RvDiscount
- RgDiscount
- VgDiscount
- Reliability1Discount
- Reliability2Discount
- Reliability3Discount
- TechnologicalCostsViapDiscount

- TechnologicalCostsDiscount
- GeneralInterestDiscount
- VkPayingRecoveredEnergyDiscount
- VkPayingRecoveredMixedDiscount
- VkMissingEnergyDiscount
- VkMissingEnergyViapDiscount
- VkMissingEnergySppdDiscount
- VkMissingEnergyDiscountDiscount
- GaAmountNoVAT
- VkAmountNoVAT
- VkViapAmountNoVAT
- VkSppdAmountNoVAT
- VkDiscountAmountNoVAT
- DdAmountNoVAT
- DdViapAmountNoVAT
- DdSppdAmountNoVAT
- DdDiscountAmountNoVAT
- NkAmountNoVAT
- NkViapAmountNoVAT
- NkSppdAmountNoVAT
- NkDiscountAmountNoVAT
- MaAmountNoVAT
- MaViapAmountNoVAT
- VdAmountNoVAT
- VdViapAmountNoVAT
- SvAmountNoVAT
- SvViapAmountNoVAT
- MiAmountNoVAT
- MiViapAmountNoVAT
- RvAmountNoVAT
- RgAmountNoVAT
- VgAmountNoVAT
- Reliability1AmountNoVAT
- Reliability2AmountNoVAT
- Reliability3AmountNoVAT
- TechnologicalCostsViapAmountNoVAT
- TechnologicalCostsAmountNoVAT
- GeneralInterestAmountNoVAT
- VkPayingRecoveredEnergyAmountNoVAT
- DdPayingRecoveredEnergyAmountNoVAT
- NkPayingRecoveredEnergyAmountNoVAT

		<ul style="list-style-type: none"> • MaPayingRecoveredEnergyAmountNoVAT • VdPayingRecoveredEnergyAmountNoVAT • SvPayingRecoveredEnergyAmountNoVAT • MiPayingRecoveredEnergyAmountNoVAT • VkPayingRecoveredMixedAmountNoVAT • DdPayingRecoveredMixedAmountNoVAT • NkPayingRecoveredMixedAmountNoVAT • MaPayingRecoveredMixedAmountNoVAT • VdPayingRecoveredMixedAmountNoVAT • SvPayingRecoveredMixedAmountNoVAT • MiPayingRecoveredMixedAmountNoVAT • VkMissingEnergyAmountNoVAT • VkMissingEnergyViapAmountNoVAT • VkMissingEnergySppdAmountNoVAT • DdMissingEnergyAmountNoVAT • DdMissingEnergyViapAmountNoVAT • DdMissingEnergySppdAmountNoVAT • NkMissingEnergyAmountNoVAT • NkMissingEnergyViapAmountNoVAT • NkMissingEnergySppdAmountNoVAT • MaMissingEnergyAmountNoVAT • MaMissingEnergyViapAmountNoVAT • VdMissingEnergyAmountNoVAT • VdMissingEnergyViapAmountNoVAT • SvMissingEnergyAmountNoVAT • SvMissingEnergyViapAmountNoVAT • MiMissingEnergyAmountNoVAT • MiMissingEnergyViapAmountNoVAT • VkMissingEnergyDiscountAmountNoVAT • DdMissingEnergyDiscountAmountNoVAT • NkMissingEnergyDiscountAmountNoVAT • PowerPlantCapacityAmountNoVAT • PermanentHomePlusAmountNoVAT • PermanentHomeAmountNoVAT
0.6.26	2021-04-30	<p>Added error message text and 111 error code.</p> <ul style="list-style-type: none"> • POST /supplier/v2/supplier-change-notifications (new) <p>Added the rule 3 description and the new message (Code 10).</p>

		<ul style="list-style-type: none"> • POST /data/data-orders
0.6.27	2021-05-07	<p>(will be deployed in next sprint) Added new json fields "clientName", "contractType", "currentSupplierType" and json field "contractType" rename to "contractModel", change "contractModel" possible values in:</p> <ul style="list-style-type: none"> ▪ POST /supplier/client/client-objects-information (new)
0.6.28	2021-05-13	<p>Updated 9 error and 11 rule.</p> <ul style="list-style-type: none"> ▪ POST /gateway/supplier/send-declaration-data
0.6.29	2021-06-03	<p>Updated 1 rule in:</p> <ul style="list-style-type: none"> ▪ POST /supplier/cancel-supplier-change-notification
0.6.30	2021-06-07	Added contract data controller.
0.6.31	2021-06-08	<p>Added new error message and rule description (4).</p> <ul style="list-style-type: none"> • POST /data/data-orders
0.6.32	2021-06-09	<p>Edited 108 error message.</p> <ul style="list-style-type: none"> • POST /supplier/v2/supplier-change-notifications (new)
0.6.33	2021-06-11	<p>The rule 55 was added.</p> <ul style="list-style-type: none"> • POST /contract-data/{changeType}/contract-change-notification
0.6.34	2021-06-16	<p>Updated JSON specification of POST /reports/accounting-data-pack-b2c method and /reports/accounting-data-pack-b2b-meters-level method. Added new fields:</p> <ul style="list-style-type: none"> ▪ GeneratingCustomer
0.6.35	2021-06-17	<p>Edited rule 2 description and error message 5;</p> <ul style="list-style-type: none"> - POST /data/data-orders
0.6.36	2021-06-22	<p>The new JSON field (contractType) and rule description were added;</p> <ul style="list-style-type: none"> • POST /reports/objects-data-pack?first={integer}&count={integer}
0.6.37	2021-06-22	Updated method (from GET to POST):

		<ul style="list-style-type: none"> • POST /gateway/contract-data/{changeType}/objects-list?first={integer}&count={integer}&sort={ASC/DSC} • POST /contract-data/contract-change-notification-details?first={integer}&count={integer}&sort={ASC/DSC}
0.6.38	2021-07-08	<p>Updated method URI name:</p> <ul style="list-style-type: none"> ▪ POST /gateway/contract-data/{changeType}/objects-list?first={integer}&count={integer}&sortKey={string}&sortOrder={ASC/DSC} ▪ POST /gateway/contract-data/contract-change-notification-details?first={integer}&count={integer}&sortOrder={ASC/DSC} ▪ POST /gateway/contract-data/{changeType}/contract-change-notification ▪ POST /gateway/contract-data/cancel-contract-change-notification/{notificationId} <p>Updated method 'POST /gateway/contract-data/{changeType}/contract-change-notification' error and rules numbering.</p> <p>Inserted HTTP status code '204' in method:</p> <ul style="list-style-type: none"> • POST /gateway/contract-data/{changeType}/objects-list?first={integer}&count={integer}&sortKey={string}&sortOrder={ASC/DSC} • POST /gateway/contract-data/contract-change-notification-details?first={integer}&count={integer}&sortOrder={ASC/DSC} • POST /gateway/contract-data/cancel-contract-change-notification/{notificationId}
0.6.39	2021-07-13	<p>Updated json structure:</p> <ul style="list-style-type: none"> • POST /gateway/contract-data/contract-change-notification-details?first={integer}&count={integer}&sortOrder={ASC/DSC} • POST /gateway/contract-data/{changeType}/contract-change-notification
0.6.40	2021-07-14	Added contract termination notification controller.
0.6.41	2021-07-16	<p>Updated oldContractInfo segment json in:</p> <ul style="list-style-type: none"> • POST /gateway/contract-data/contract-change-notification-details?first={integer}&count={integer}&sortOrder={ASC/DSC}
0.6.42	2021-08-03	<p>Updated correspondenceAddress segment json in:</p> <ul style="list-style-type: none"> • POST /gateway/contract-data/contract-change-notification-details?first={integer}&count={integer}&sortOrder={ASC/DSC}
0.6.43	2021-08-04	Added an additional status „I - Sent“ of contract data controller.
0.6.44	2021-08-05	<p>Added the new methods for the reports' orders.</p> <ul style="list-style-type: none"> • Metodas reports-orders-list <ul style="list-style-type: none"> ◦ POST/gateway/report-order-data/{supplierCode}/reports-orders-list?first={integer}&count={integer}&sortKey={string}&sortOrder={ASC/DSC} • Metodas report-order-details <ul style="list-style-type: none"> ◦ GET/gateway/report-order-data/{supplierCode}/report-order-details/{orderId} • Metodas order-hourly-report-data

		<ul style="list-style-type: none"> ○ POST/gateway/report-order-data/{supplierCode}/{reportShortName}/order-hourly-report-data • Metodas order-report-data <ul style="list-style-type: none"> ○ POST/gateway/report-order-data/{supplierCode}/{reportShortName}/order-report-data • Metodas ordered-report-hr <ul style="list-style-type: none"> ○ GET/gateway/report-order-data/{supplierCode}/ordered-report-hr/{orderId}
		<p>Added the new methods for the reports' orders. Metodas ordered-report-obj</p> <ul style="list-style-type: none"> • GET/gateway/report-order-data/{supplierCode}/ordered-report-obj/{orderId}
		<p>Added the new methods for the reports' orders.</p> <ul style="list-style-type: none"> • GET/gateway/report-order-data/{supplierCode}/ordered-report-b2c/{orderId} Metodas ordered-report-b2b • GET/gateway/report-order-data/{supplierCode}/ordered-report-b2b/{orderId} Metodas ordered-report-b2bm • GET/gateway/report-order-data/{supplierCode}/ordered-report-b2bm/{orderId}
0.6.45	2021-08-09	<p>Changed 12 and 17 error messages in method:</p> <ul style="list-style-type: none"> • POST /gateway/contract-data/{changeType}/contract-change-notification
0.6.46	2021-08-10	<p>ContractModel moved to object level in method:</p> <ul style="list-style-type: none"> • POST /gateway/contract-data/{changeType}/contract-change-notification
0.6.47	2021-08-11	<p>Changed 14 error message and added 36 error message in method:</p> <ul style="list-style-type: none"> • POST /gateway/contract-data/{changeType}/contract-change-notification
0.6.48	2021-08-12	<p>Added 37, 38, 39, 40 error messages and 50, 51, 52, 53 rules in method:</p> <ul style="list-style-type: none"> • POST /gateway/contract-data/{changeType}/contract-change-notification
0.6.49	2021-08-24	<p>Added 41, 42 error messages and modified 53, 6, 54, 56 rules in method:</p> <ul style="list-style-type: none"> • POST /gateway/contract-data/{changeType}/contract-change-notification <p>Changed 33 error message code into 1003 in method:</p> <ul style="list-style-type: none"> • POST /gateway/contract-data/{changeType}/contract-change-notification <p>Added json field ,payoffMethod' in method:</p> <ul style="list-style-type: none"> • POST /gateway/contract-data/{changeType}/objects-list?first={integer}&count={integer}&sortKey={string}&sortOrder={ASC/DSC} <p>Added json field ,payoffMethod' in ,oldContractInfo.object' group, in method:</p> <ul style="list-style-type: none"> • POST /gateway/contract-data/contract-change-notification-details?first={integer}&count={integer}&sortOrder={ASC/DSC} <p>Added 14 error message and rule description</p> <ul style="list-style-type: none"> • POST /gateway/supplier/send-declaration-data <p>Changed 1, 2 error codes into 1001 and 1002 in:</p> <ul style="list-style-type: none"> • contract data controller • contract data controller - termination data <p>Removed 4 error from:</p>

		<ul style="list-style-type: none"> • POST /gateway/contract-data/{changeType}/objects-list?first={integer}&count={integer}&sortKey={string}&sortOrder={ASC/DSC}
0.6.50	2021-08-30	<p>Removed the field ‚ownershipDocumentDate‘ in method:</p> <ul style="list-style-type: none"> • POST /gateway/contract-data/contract-change-notification-details?first={integer}&count={integer}&sortOrder={ASC/DSC}
0.6.51	2021-08-31	<p>Modified 23 rule and 41 error message in method:</p> <ul style="list-style-type: none"> • POST /gateway/contract-data/{changeType}/contract-change-notification <p>Added 54 rule and 43 error message in method:</p> <ul style="list-style-type: none"> • POST /gateway/contract-data/{changeType}/contract-change-notification
0.6.52	2021-09-03	<p>Added 58, 59, 60 rules and 44, 45, 46 error messages in method:</p> <ul style="list-style-type: none"> • POST /gateway/contract-data/{changeType}/contract-change-notification
0.6.53	2021-09-10	<p>Added the GET method of the 2SS report:</p> <ul style="list-style-type: none"> • GET/gateway/report-order-data/ordered-report-data-2ss/{orderId}
0.6.54	2021-09-23	<p>Added the description of the 9 error message:</p> <ul style="list-style-type: none"> • POST /gateway/supplier/send-declaration-data
0.6.55	2021-09-27	<p>Added json field objectDataConsentSign and 3, 4, 5 rules in method:</p> <ul style="list-style-type: none"> • POST /gateway/contract-data/{changeType}/objects-list?first={integer}&count={integer}&sortKey={string}&sortOrder={ASC/DSC} <p>Modified 28, 31 rules and added 61, 62 rules and 48, 49 errors in method:</p> <ul style="list-style-type: none"> • POST /gateway/contract-data/{changeType}/contract-change-notification
0.6.56	2021-09-28	<p>Added rule description 5:</p> <ul style="list-style-type: none"> • GET/gateway/report-order-data/ordered-report-data-hr/{orderId}
0.6.57	2021-10-04	<p>Value of json field „status“ was modified from „PR – Approved“ into „IV – Completed“ in controller:</p> <ul style="list-style-type: none"> • Contract data controller • Contract data controller – termination data
0.6.58	2021-10-06	<p>Added 19 rule and 120 error in method:</p> <ul style="list-style-type: none"> • POST /gateway/contract-data/termination-data/contract-termination-notification
0.6.59	2021-10-12	<p>Removed 5 rule in method:</p> <ul style="list-style-type: none"> • POST /gateway/contract-data/{changeType}/objects-list?first={integer}&count={integer}&sortKey={string}&sortOrder={ASC/DSC}
0.6.60	2021-10-13	<p>Removed “JSON request”: dateFrom, dateTo. Added “JSON request”: contractSartFrom, contractStartTo, submittedDateFrom, submittedDateTo, in method:</p> <ul style="list-style-type: none"> • POST /gateway/contract-data/contract-change-notification-details?first={integer}&count={integer}&sortOrder={ASC/DSC} <p>Removed “JSON request”: dateFrom, dateTo. Added “JSON request”: contractTerminationDateFrom, contractTerminationDateTo, submittedDateFrom, submittedDateTo, in method:</p> <ul style="list-style-type: none"> • POST /gateway/contract-data/termination-data/contract-termination-notification-details?first={integer}&count={integer}&sortOrder={ASC/DSC}
0.6.61	2021-10-15	<p>Added the new supplier change notification v2 controller: -POST method:</p>

		<ul style="list-style-type: none"> • POST /gateway/supplier-change-notification/v2/objects-list?first={integer}&count={integer}&sortKey={string}&sortOrder={ASC/DSC}
0.6.62	2021-10-19	<p>Added the POST methods of supplier change notification v2 controller:</p> <ul style="list-style-type: none"> • POST /gateway/supplier-change-notification/v2/list?first={integer}&count={integer}&sortKey={string}&sortOrder={ASC/DSC} • POST /gateway/supplier-change-notification/v2 • POST /gateway/supplier-change-notification/v2/{notificationId}/cancel
0.6.63	2021-10-17	<p>Added new fields noCoowner, ntGetCoownerConsent, coownerConsentDate in method:</p> <ul style="list-style-type: none"> • POST /gateway/contract-data/termination-data/contract-termination-notification-details?first={integer}&count={integer}&sortOrder={ASC/DSC}
0.6.64	2021-10-28	<p>Added submittedDateFrom/To attribute to the JSON request:</p> <ul style="list-style-type: none"> • POST/gateway/report-order-data/reports-orders-list?first={integer}&count={integer}&sortKey={string}&sortOrder={ASC/DSC} <p>Removed the error message (error code 9) from the new methods of the reports. Changed searchParameter to orderParameter. Changed auto_order to auto.</p> <p>Edited the attributes of the JSON request:</p> <ul style="list-style-type: none"> • POST/gateway/report-order-data/{reportShortName}/order-report-data.
0.6.65	2021-10-29	<p>Removed “JSON request”: objectNumbers. Added “JSON request”: objects, objectNumber, noCoowner, ntGetCoownerConsent, coownerConsentDate AND added new error messages (no. 20 – 26) in method:</p> <ul style="list-style-type: none"> • POST /gateway/contract-data/termination-data/contract-termination-notification
0.6.66	2021-11-03	<p>Edited the structure of the JSON:</p> <ul style="list-style-type: none"> • GET/gateway/report-order-data/ordered-report-data-2ss/{orderId}
0.6.67	2021-11-05	<p>Added JSON attribute „userName“:</p> <ul style="list-style-type: none"> • POST /gateway/supplier-change-data/supplier-change-notification-list?first={integer}&count={integer}&sortKey={string}&sortOrder={ASC/DSC} • POST /gateway/contract-data/termination-data/contract-termination-notification-details?first={integer}&count={integer}&sortOrder={ASC/DSC} • POST /gateway/contract-data/contract-change-notification-details?first={integer}&count={integer}&sortOrder={ASC/DSC} <p>Added JSON parameters „userNameSearch“:</p> <ul style="list-style-type: none"> • POST /gateway/supplier-change-data/supplier-change-notification-list?first={integer}&count={integer}&sortKey={string}&sortOrder={ASC/DSC} • POST /gateway/contract-data/termination-data/contract-termination-notification-details?first={integer}&count={integer}&sortOrder={ASC/DSC} • POST /gateway/contract-data/contract-change-notification-details?first={integer}&count={integer}&sortOrder={ASC/DSC}

0.6.68	2021-11-08	<p>Added 63 rule and 51 error in method:</p> <ul style="list-style-type: none"> • POST /gateway/contract-data/{changeType}/contract-change-notification
0.6.69	2021-11-11	<p>Changed URL (Contract termination notification controller):</p> <ul style="list-style-type: none"> • POST /gateway/contract-termination-notification/object-list?first={integer}&count={integer}&sortKey={string}&sortOrder={ASC/DSC} • POST /gateway/contract-termination-notification/details?first={integer}&count={integer}&sortOrder={ASC/DSC} • POST /gateway/contract-termination-notification • POST /gateway/contract-termination-notification/{notificationId}/cancel
0.6.70	2021-11-11	Name of Contract data controller was changed into Contract change notification controller.
0.6.71	2021-11-11	<p>Changed URL (Supplier change notification controller):</p> <ul style="list-style-type: none"> • POST /gateway/supplier-change-notification/v2/object-list?first={integer}&count={integer}&sortKey={string}&sortOrder={ASC/DSC} • POST /gateway/supplier-change-notification/v2/list?first={integer}&count={integer}&sortKey={string}&sortOrder={ASC/DSC} • POST /gateway/supplier-change-notification/v2 • POST /gateway/supplier-change-notification/v2/{notificationId}/cancel
0.6.72	2021-11-12	<p>Changed URL (Order controller):</p> <ul style="list-style-type: none"> • POST/gateway/order/list?first={integer}&count={integer}&sortKey={string}&sortOrder={ASC/DSC} • GET/gateway/order/{orderId}/details • POST/gateway/order/{orderShortName}/hourly • POST/gateway/order/{orderShortName} • GET/gateway/order/{orderId}/hr • GET/gateway/order/{orderId}/2ss <p>Changed URL (Order controller):</p> <ul style="list-style-type: none"> • GET/gateway/order/{orderId}/obj <p>Changed URL (Order controller):</p> <ul style="list-style-type: none"> • GET/gateway/order/{orderId}/b2c • GET/gateway/order/{orderId}/b2b
0.6.73	2021-11-15	<p>Error message was deleted:</p> <ul style="list-style-type: none"> • POST/gateway/order/{orderShortName}

		<p>Changed the JSON structure, added new attribute:</p> <ul style="list-style-type: none"> • GET/gateway/order/{orderId}/obj
0.6.74	2021-11-15	<p>Added the new error message 1004:</p> <ul style="list-style-type: none"> • POST /reports/accounting-data-pack-b2c?first={integer}&count={integer} • POST /reports/accounting-data-pack-b2b?first={integer}&count={integer} • POST /reports/accounting-data-pack-b2b-meters-level?first={integer}&count={integer} • POST /reports/objects-data-pack?first={integer}&count={integer}
0.6.75	2021-11-15	<p>Changed 46, 15, 16 rules and deleted 36 error in method:</p> <ul style="list-style-type: none"> • POST /gateway/contract-data/{changeType}/contract-change-notification
0.6.76	2021-11-17	<p>JSON attributes were changed:</p> <ul style="list-style-type: none"> • POST/gateway/order/{orderShortName}
		<p>JSON attributes were changed:</p> <ul style="list-style-type: none"> • GET/gateway/order/{orderId}/obj
0.6.77	2021-11-18	<p>(Order controller) B2B order was deleted. B2Bm was renamed to B2B. Added the new error message and deleted the attribute "statusDate"</p> <ul style="list-style-type: none"> • POST/gateway/order/list?first={integer}&count={integer}&sortKey={string}&sortOrder={ASC/DSC} • Order controller codes of the error messages were changed.
0.6.78	2021-11-19	<p>Changed 17 error message in method:</p> <ul style="list-style-type: none"> • POST /gateway/contract-data/{changeType}/contract-change-notification
0.6.79	2021-11-24	<p>JSON request attributes were deleted:</p> <ul style="list-style-type: none"> • POST/gateway/order/{orderShortName} <p>Added the new error message:</p> <ul style="list-style-type: none"> • POST/gateway/order/{orderShortName}/hourly
0.6.80	2021-12-03	<p>Changed data type of the attributes (submittedDateFrom, submittedDateTo, dateFrom, dateTo)</p> <ul style="list-style-type: none"> • POST/gateway/order/list?first={integer}&count={integer}&sortKey={string}&sortOrder={ASC/DSC} • POST/gateway/order/{orderShortName} <p>Deleted error message 2003:</p> <ul style="list-style-type: none"> • POST/gateway/order/list?first={integer}&count={integer}&sortKey={string}&sortOrder={ASC/DSC} <p>Edited error message 2003:</p> <ul style="list-style-type: none"> • POST/gateway/order/{orderShortName}

		<ul style="list-style-type: none"> • POST/gateway/order/{orderShortName}/hr
0.6.81	2021-12-06	Deleted 2006 error message, changed 2001 error message <ul style="list-style-type: none"> • POST/gateway/order/{orderShortName}
0.6.82		Added the new error message 2015 <ul style="list-style-type: none"> • POST/gateway/order/{orderShortName} • POST/gateway/order/{orderShortName}/hr
0.6.83	2021-12-09	Changed JSON request structure, deleted 2001 error message and edited 2007 error message: <ul style="list-style-type: none"> • POST/gateway/order/{orderShortName}/hr
0.6.84	2021-12-10	Added the error messages and rule description 112,113: <ul style="list-style-type: none"> • POST /gateway/supplier-change-notification/v2 • POST /supplier/v2/supplier-change-notifications
0.6.85	2021-12-13	Added new controller: "Contract object". <ul style="list-style-type: none"> • Added new method: POST /gateway/contract-object/list?first={integer}&count={integer}&sortKey={string}&sortOrder={ASC/DSC} The method is designed to obtain a list of valid objects in the contract according to the selection criteria. • Removed method: POST /gateway/contract-termination-notification/object-list?first={integer}&count={integer}&sortKey={string}&sortOrder={ASC/DSC}
0.6.86	2021-12-14	Added the new controller and methods: <ul style="list-style-type: none"> • The new controller – Tariff plan change notification controller • POST /gateway/tariff-plan-change-notification/list??first={integer}&count={integer}&sortKey={string}&sortOrder={ASC/DSC} • POST /gateway/tariff-plan-change-notification • POST /gateway/tariff-plan-change-notification/{notificationId}/cancel
0.6.87	2021-12-16	Removed 25 and 26 error in method: <ul style="list-style-type: none"> • POST /gateway/contract-data/{changeType}/contract-change-notification
0.6.88	2021-12-21	Added the contract list controller: <ul style="list-style-type: none"> • POST/gateway/contract/list?first={integer}&count={integer}&sortKey={string}&sortOrder={ASC/DSC}
0.6.89	2021-12-22	Added the new controller – Contact change notification controller: <ul style="list-style-type: none"> • POST /gateway/contact-change-notification/list??first={integer}&count={integer}&sortKey={string}&sortOrder={ASC/DSC}

		<ul style="list-style-type: none"> • POST /gateway/contact-change-notification • POST /gateway/contact-change-notification/{notificationId}/cancel
0.6.90	2021-12-22	<p>Edited the 112 and 103 error messages. Added the new error 116</p> <ul style="list-style-type: none"> • POST /supplier/v2/supplier-change-notifications (new)
0.6.91	2021-12-23	<p>Added new json field `mobPhoneNoObject` in method:</p> <ul style="list-style-type: none"> • POST /gateway/object/my/active/list?first={integer}&count={integer}&sortKey={string}&sortOrder={ASC/DSC}
0.6.92	2021-12-23	<p>Edited JSON structure:</p> <ul style="list-style-type: none"> • GET/gateway/order/{orderId}/2ss <p>Changed attribute name:</p> <ul style="list-style-type: none"> • GET/gateway/order/{orderId}/obj
0.6.93	2021-12-30	<p>Added new 117 error in method:</p> <ul style="list-style-type: none"> • POST /supplier/v2/supplier-change-notifications (new)
0.6.94	2022-01-04	<p>Changed GET url:</p> <ul style="list-style-type: none"> • GET/gateway/order/{orderId}/2s2s <p>Changed orderShortName and orderName from 2ss to 2s2s:</p> <ul style="list-style-type: none"> • POST/gateway/order/list?first={integer}&count={integer}&sortKey={string}&sortOrder={ASC/DSC} • POST/gateway/order/{orderShortName} <p>Changed username attribute to usreName:</p> <ul style="list-style-type: none"> • POST/gateway/order/list?first={integer}&count={integer}&sortKey={string}&sortOrder={ASC/DSC}
0.6.95	2022-01-06	<p>Deleted POST and GET methods:</p> <ul style="list-style-type: none"> • POST/gateway/order/{orderShortName}/hr • GET/gateway/order/{orderId}/hr <p>Added new methods:</p> <ul style="list-style-type: none"> • POST/gateway/order/hr-object • POST/gateway/order/hr-meter • GET/gateway/order/{orderId}/hr-object • GET/gateway/order/{orderId}/hr-meter • GET/gateway/order/{orderId}/hr-object/count • GET/gateway/order/{orderId}/hr-meter/count
0.6.96	2022-01-11	<p>Changed the structure of the JSON Response</p> <ul style="list-style-type: none"> • GET/gateway/order/{orderId}/2s2s

0.9.97	2022-01-13	<p>Added new 127 error and 26 rule in method:</p> <ul style="list-style-type: none"> • POST /gateway/contract-termination-notification
0.9.98	2022-01-13	<p>Removed “ntGetCoownerConsent”, renamed “noCoowner” into “coowner” in methods:</p> <ul style="list-style-type: none"> • POST /gateway/contract-termination-notification/details?first={integer}&count={integer}&sortOrder={ASC/DSC} • POST /gateway/contract-termination-notification <p>Edited 121, 122 error, removed 124, 125 error, added 128 error in method:</p> <ul style="list-style-type: none"> • POST /gateway/contract-termination-notification
0.9.99	2022-01-14	<p>Deleted the methods:</p> <ul style="list-style-type: none"> • POST/gateway/order/hr-object • POST/gateway/order/hr-meter • GET/gateway/order/{orderId}/hr-object/count • GET/gateway/order/{orderId}/hr-meter/count <p>Added the method:</p> <ul style="list-style-type: none"> • POST/gateway/order/{orderShortName} • GET/gateway/order/{orderId}/{orderShortName}/count <p>Added the error message 2016 and 2017 for the GET methods.</p>
0.7.0	2022-01-17	<p>JSON attribute changed from consumerCode to personCode</p> <ul style="list-style-type: none"> • GET/gateway/order/{orderId}/hr-object • GET/gateway/order/{orderId}/hr-meter <p>Added new attribute objectBsId to JSON respons structure:</p> <ul style="list-style-type: none"> • GET/gateway/order/{orderId}/hr-object • GET/gateway/order/{orderId}/hr-meter
		<p>Added new attribute objectBsId to JSON respons structure:</p> <ul style="list-style-type: none"> • GET/gateway/order/{orderId}/2s2s
		<p>Added new attribute objectBsId to JSON respons structure:</p> <ul style="list-style-type: none"> • GET/gateway/order/{orderId}/obj
0.7.1	2022-01-24	<ul style="list-style-type: none"> • “Contract object controller” renamed into “Object controller” • Url “POST /gateway/contract-object/list?first={integer}&count={integer}&sortKey={string}&sortOrder={ASC/DSC}” renamed into “POST /gateway/object/my/active/list?first={integer}&count={integer}&sortKey={string}&sortOrder={ASC/DSC}” • Added new field “supplyOwnership” in method: “POST /gateway/object/my/active/list?first={integer}&count={integer}&sortKey={string}&sortOrder={ASC/DSC}” • A new method “POST /gateway/object/all/active/list?first={integer}&count={integer}&sortKey={string}&sortOrder={ASC/DSC}”

		<p>er={ASC/DSC}" has been created for the method "POST /gateway/contract-data/{changeType}/objects-list?first={integer}&count={integer}&sortKey={string}&sortOrder={ASC/DSC}".</p> <p>Changes are highlighted in green in method: "POST /gateway/object/all/active/list?first={integer}&count={integer}&sortKey={string}&sortOrder={ASC/DSC}"</p> <ul style="list-style-type: none"> • A method: "POST /gateway/contract-data/{changeType}/objects-list?first={integer}&count={integer}&sortKey={string}&sortOrder={ASC/DSC}" will be eliminated. • Removed 40 error in method: POST /gateway/contract-data/{changeType}/contract-change-notification
0.7.2	2022-01-24	<p>Added the new method in the Order controller:</p> <ul style="list-style-type: none"> • GET/gateway/order/list/count <p>Changed parameter name from orderShortName to hrOrderShortName:</p> <ul style="list-style-type: none"> • POST/gateway/order/{hrOrderShortName}
0.7.3	2022-01-24	<p>"Tariff plan change notification controller" renamed into "Notification contract tariff plan controller".</p> <p>Changed URL in the "Notification contract tariff plan controller":</p> <ul style="list-style-type: none"> • POST /gateway/notification/contract/tariff-plan/list?first={integer}&count={integer}&sortKey={string}&sortOrder={ASC/DSC} • POST /gateway/notification/contract/tariff-plan • POST /gateway/notification/{notificationId}/contract/tariff-plan/cancel <p>"Contact change notification controller" renamed into "Notification contract contact controller".</p> <p>Changed URL in the "Notification contract contact controller":</p> <ul style="list-style-type: none"> • POST /gateway/notification/contract/contact/list?first={integer}&count={integer}&sortKey={string}&sortOrder={ASC/DSC} • POST /gateway/notification/contract/contact • POST /gateway/notification/{notificationId}/contract/contact/cancel
0.7.4	2022-01-24	<p>"Contract termination notification controller" renamed into "Notification contract termination controller".</p> <p>Changed URL in the "Notification contract termination controller":</p> <ul style="list-style-type: none"> • POST /gateway/notification/contract/termination/list?first={integer}&count={integer}&sortOrder={ASC/DSC} • POST /gateway/notification/contract/termination • POST /gateway/notification/{notificationId}/contract/termination/cancel
0.7.5	2022-01-24	<p>Added new controller "Notification contract controller".</p> <ul style="list-style-type: none"> • Methods in this controller are very similar to method in controller „Contract change notification controller“. Differences are highlighted in green. • Note: The controller "Contract change notification controller" and its methods will be eliminated after "Notification contract controller" implementation date + 6 months.

0.7.6	2022-01-27	<p>Changed 10, 11, 17 rules and 11 error in method:</p> <ul style="list-style-type: none"> • POST /gateway/contract-data/{changeType}/contract-change-notification <p>Note: In the new method “POST /gateway/notification/contract/owner”, these rules and error will also be implemented.</p>
0.7.7	2022-01-27	<p>Added new attribute (statusDate) in the method: POST/gateway/order/list?first={integer}&count={integer}&sortKey={string}&sortOrder={ASC/DSC}</p>
0.7.8	2022-01-28	<p>Removed controller and its methods “Supplier change notification v2 controller”. It has not yet been implemented, only a change in the documentation.</p>
0.7.9	2022-01-31	<p>Added errorType in method: POST /gateway/notification/contract/list?first={integer}&count={integer}&sortOrder={ASC/DSC}</p>
0.7.10	2022-01-31	<p>Added errorType in method: POST /gateway/notification/contract/termination/list?first={integer}&count={integer}&sortOrder={ASC/DSC}</p>
0.7.11	2022-02-01	<p>Edited 71 error and 10 rule in method: POST /gateway/notification/contract/termination</p>
0.7.12	2022-02-03	<p>Added the new rule 2018:</p> <ul style="list-style-type: none"> • GET/gateway/order/{orderId}/hr-object • GET/gateway/order/{orderId}/hr-meter • GET/gateway/order/{orderId}/2s2s
		<p>Added the new rule 2018:</p> <ul style="list-style-type: none"> • GET/gateway/order/{orderId}/obj
		<p>Added the new rule 2018:</p> <ul style="list-style-type: none"> • GET/gateway/order/{orderId}/b2c • GET/gateway/order/{orderId}/b2b
0.7.13	2022-02-04	<p>Deleted the error message 2007:</p> <ul style="list-style-type: none"> • POST/gateway/order/{hrOrderShortName}; • POST/gateway/order/{orderShortName}
0.7.14	2022-02-07	<p>Deleted satusDate attribute:</p> <ul style="list-style-type: none"> • POST/gateway/order/list
0.7.15	2022-02-11	<p>Edited 24 error in method:</p> <ul style="list-style-type: none"> • POST /gateway/contract-data/{changeType}/contract-change-notification

0.7.16	2022-02-17	Added the attribute statusDate in JSON response structure of the method: <ul style="list-style-type: none"> • POST/gateway/order/list
0.7.17	2022-02-21	Changed data type from timestamp to date and attributes names were changed: <ul style="list-style-type: none"> • GET/gateway/order/{orderId}/obj
		consumptionCategory changed from not required to required: <ul style="list-style-type: none"> • POST/gateway/order/{hrOrderShortName}
0.7.18	2022-02-22	Added "meterNumbers":[string] in method: <ul style="list-style-type: none"> • POST /gateway/notification/contract/list?first={integer}&count={integer}&sortOrder={ASC/DSC}
0.7.19	2022-02-22	Added method: <ul style="list-style-type: none"> • POST/v2/data/data-orders This method already exists, was lost in the documentation
0.7.20	2022-02-23	Added new error message 1004: <ul style="list-style-type: none"> • POST/gateway/order/{hrOrderShortName} • POST/gateway/order/{orderShortName}
		Changed JSON attributes names: personName; personSurnaem; objectId: <ul style="list-style-type: none"> • GET/gateway/order/{orderId}/2s2s • GET/gateway/order/{orderId}/hr-object • GET/gateway/order/{orderId}/hr-meter
		Changed JSON attributes names: personName; personSurnaem; objectId: <ul style="list-style-type: none"> • GET/gateway/order/{orderId}/obj
0.7.21	2022-02-28	Added the new rule 2019 in Order controller: <ul style="list-style-type: none"> • POST/gateway/order/{orderShortName}
0.7.22	2022-03-02	Changed JSON response structure, generatingObjectType moved to product level: <ul style="list-style-type: none"> • GET/gateway/order/{orderId}/2s2s
0.7.23	2022-03-03	Removed 39 error in method: <ul style="list-style-type: none"> • POST /gateway/notification/contract/owner • POST /gateway/contract-data/{changeType}/contract-change-notification
0.7.24	2022-03-07	Added json field PayoffMethod in method: <ul style="list-style-type: none"> • POST /reports/objects-data-pack?first={integer}&count={integer}
0.7.25	2022-03-08	Added method: <ul style="list-style-type: none"> • POST /gateway/declaration/reading/list
0.7.26	2022-03-21	Deleted rule description. <ul style="list-style-type: none"> • POST/gateway/order/{hrOrderShortName}
0.7.27	2022-03-22	Added objectPowers in method: <ul style="list-style-type: none"> • POST /gateway/object/all/active/list?first={integer}&count={integer}&sortKey={string}&sortOrder={ASC/DSC}

0.7.28	2022-03-25	Changed the JSON response attribute name from the status to latestStatus: <ul style="list-style-type: none"> • POST/gateway/order/list
0.7.29	2022-03-28	Changed attribute name from orderShortName to orderType: <ul style="list-style-type: none"> • POST/gateway/order/list • POST/gateway/order/list/count
0.7.30	2022-03-28	Removed json tariffPlanCategory in method: <ul style="list-style-type: none"> • POST /gateway/object/my/active/list?first={integer}&count={integer}&sortKey={string}&sortOrder={ASC/DSC}
0.7.31	2022-03-31	Edited json request attribute from objectNumber to objectNumbers <ul style="list-style-type: none"> • POST/order/{hrOrderShortName}
0.7.32	2022-03-31	Edited json request attribute from orderType to orderTypes <ul style="list-style-type: none"> • POST/gateway/order/list
0.7.33	2022-04-01	Edited json request attribute "status", added json request attribute "changeType" in method: <ul style="list-style-type: none"> • POST /gateway/notification/contract/list?first={integer}&count={integer}&sortOrder={ASC/DSC}
0.7.34	2022-04-04	Changed HTTP status from 200 to 201 in method: <ul style="list-style-type: none"> • POST/gateway/order/{orderShortName} • POST/gateway/order/{hrOrderShortName}
0.7.35	2022-04-05	Added "6.1.3.4 Algorithm for using DELTA solution". Method: <ul style="list-style-type: none"> • POST /gateway/declaration/reading/list
0.7.36	2022-04-07	Changed possible meanings "orderType". Method: <ul style="list-style-type: none"> • POST/gateway/order/list?first={integer}&count={integer}&sortKey={string}&sortOrder={ASC/DSC} Changed a parameter "hr15OrderShortName" and url. Method: <ul style="list-style-type: none"> • POST/gateway/order/{hr15OrderShortName} Changed a parameter "orderShortName". Method: <ul style="list-style-type: none"> • POST/gateway/order/{orderShortName} Changed url from "GET/gateway/order/{orderId}/hr-object" to "GET/gateway/order/{orderId}/data-hr-15min-obj-lvl". Changed url from "GET/gateway/order/{orderId}/hr-meter" to "GET/gateway/order/{orderId}/data-hr-15min-mtr-lvl". Changed url from "GET/gateway/order/{orderId}/2s2s" to "GET/gateway/order/{orderId}/bill-2s2s-b2b". Changed url from "GET/gateway/order/{orderId}/obj" to "GET/gateway/order/{orderId}/report-obj".
0.7.37	2022-04-07	Added a new json attribute "smartMeterInstallationDate":"date". Method: <ul style="list-style-type: none"> • GET/gateway/order/{orderId}/report-obj
0.7.38	2022-04-12	Added a new request parameter "interval". Method: <ul style="list-style-type: none"> • POST/gateway/order/{hr15OrderShortName}

0.7.39	2022-04-15	<p>Implemented Order controller methods:</p> <ul style="list-style-type: none"> • POST/gateway/order/list?first={integer}&count={integer}&sortKey={string}&sortOrder={ASC/DSC} • POST/gateway/order/{hr15OrderShortName} • POST/gateway/order/{orderShortName} <p>except:</p> <p>bill-bss-b2b - Billing report for BSS model B2B; bill-bss-b2c - Billing report for BSS model B2C;</p> <ul style="list-style-type: none"> • GET/gateway/order/{orderId}/data-hr-15min-obj-lvl • GET/gateway/order/{orderId}/data-hr-15min-mtr-lvl • GET/gateway/order/{orderId}/bill-2s2s-b2b • GET/gateway/order/{orderId}/report-obj • GET/gateway/order/{orderId}/count
0.7.40	2022-04-22	<p>Deleted methods:</p> <ul style="list-style-type: none"> • POST /data/data-orders • POST /reports/accounting-data-pack-b2b?first={integer}&count={integer} • POST /reports/accounting-data-pack-b2b-count
0.7.41	2022-04-22	<p>Changed methods:</p> <ul style="list-style-type: none"> • POST /gateway/notification/contract/list?first={integer}&count={integer}&sortOrder={ASC/DSC} • POST /gateway/notification/contract • POST /gateway/notification/{notificationId}/contract/cancel <p>These methods are adapted to the NTK (change of supplier) process. All changes in SK and STK processes, also new rules for NTK process are highlighted in blue.</p>
0.7.42	2022-04-27	<p>Edited 38, 52 rules and 42 error in method:</p> <ul style="list-style-type: none"> • POST /gateway/notification/contract
0.7.43	2022-05-03	<p>Edited 4 rule, 2003 error in the method:</p> <ul style="list-style-type: none"> • POST/gateway/order/{orderShortName}
0.7.44	2022-05-03	<p>Edited 6 rule, 12 error in the method:</p> <ul style="list-style-type: none"> • POST /gateway/declaration/reading/list
0.7.45	2022-05-04	<p>Edited 10 rule in the method: POST /gateway/supplier/send-declaration-data</p>
0.7.46	2022-05-04	<ul style="list-style-type: none"> • Changed url from POST /gateway/declaration/reading/list to POST /gateway/declaration/reading/list?first={integer}&count={integer}&sortKey={string}&sortOrder={ASC/DSC} • Added sort and sortOrder parameters.
0.7.47	2022-05-05	<p>Added 68 rule and 134 error in method:</p> <ul style="list-style-type: none"> • POST /gateway/notification/contract

0.7.48	2022-05-05	<p>Edited count default value for these methods:</p> <ul style="list-style-type: none"> • GET/gateway/order/{orderId}/bill-2s2s-b2b • GET/gateway/order/{orderId}/data-hr-15min-mtr-lvl • GET/gateway/order/{orderId}/data-hr-15min-obj-lvl • GET/gateway/order/{orderId}/report-obj • POST/gateway/order/list?first={integer}&count={integer}&sortKey={string}&sortOrder={ASC/DSC}
0.7.49	2022-05-09	<p>Edited 26, 27 rules and 20, 21 errors in method:</p> <ul style="list-style-type: none"> • POST /gateway/notification/contract
0.7.50	2022-06-06	<p>Added new 141, 147, 148 errors in the method:</p> <ul style="list-style-type: none"> • POST /gateway/notification/contract <p>Added new fields representativeName, representativeSurname, representativeDuty in the method:</p> <ul style="list-style-type: none"> • POST /gateway/notification/contract/list?first={integer}&count={integer}&sortOrder={ASC/DSC} <p>Changes are highlighted in blue</p>
0.7.51	2022-06-16	<p>Changed date format of consumptionTime in method:</p> <ul style="list-style-type: none"> • GET/gateway/order/{orderId}/data-hr-15min-mtr-lvl • GET/gateway/order/{orderId}/data-hr-15min-obj-lvl <p>Example of consumptionTime format: 2022-06-07T00:00:00+02:00 2022-06-07T00:00:00+03:00</p>
0.7.52	2022-06-22	<p>Added json response field "tariffPlan" in method: GET/gateway/order/{orderId}/bill-2s2s-b2b</p>
0.7.53	2022-06-28	<p>Removed method:</p> <ul style="list-style-type: none"> • GET /gateway/supplier/v2/get-declaration-data?first={integer}&count={integer}&customerId={string}&objectNumber={string}
0.7.54	2022-06-29	<p>Added 'objectFutureSupplier' in method:</p> <ul style="list-style-type: none"> • POST /gateway/object/all/active/list?first={integer}&count={integer}&sortKey={string}&sortOrder={ASC/DSC}
0.7.55	2022-06-29	<p>Added new controller "Notification contract controller".</p> <ul style="list-style-type: none"> • Methods in this controller are very similar to method in controller „Contract change notification controller“. Differences are highlighted in green. <p>Note: The controller "Contract change notification controller" and its methods will be eliminated after "Notification contract controller" implementation date + 6 months</p>
0.7.56	2022-06-29	<p>Removed errors 112, 116, 108 for NTK (new supplier change) process. Method:</p> <ul style="list-style-type: none"> • POST /gateway/notification/contract
0.7.57	2022-06-30	<p>Added json field 'anotherSupplierContractCancellation' in method:</p> <ul style="list-style-type: none"> • POST /gateway/notification/contract/list?first={integer}&count={integer}&sortOrder={ASC/DSC}

0.7.58	2022-07-14	Added json request parameters 'supplierContractNo', 'objectAddressSearch' in method: <ul style="list-style-type: none"> • POST /gateway/notification/contract/list?first={integer}&count={integer}&sortOrder={ASC/DSC}
0.7.59	2022-07-15	Added new controller "Access right controller – new". This controller will be deployed in the future, preliminary date – 10.01.
0.7.60	2022-07-20	Added new controller "NotificationCancelation - new" This controller will be deployed in the future, preliminary date – 09.01. Added new controller "Notification contract object supply state controller" This controller will be deployed in the future, preliminary date – 10.01.
0.7.61	2022-07-22	Changed the parameter objectNumber into objectNumbers and a maximum of 500 objects can be specified. Method: <ul style="list-style-type: none"> • POST /gateway/object/all/active/list?first={integer}&count={integer}&sortKey={string}&sortOrder={ASC/DSC}
0.7.62	2022-07-25	Added response the new field "powerPlantType". Method: <ul style="list-style-type: none"> • POST /gateway/object/all/active/list?first={integer}&count={integer}&sortKey={string}&sortOrder={ASC/DSC}
0.7.63	2022-07-27	Edited rule 21 in method: <ul style="list-style-type: none"> • POST /gateway/notification/contract Edited rule 416 in method: <ul style="list-style-type: none"> • POST /gateway/notification/contract/contact Changes in methods are highlighted in blue.
0.7.64	2022-08-05	Added json field "cancelledByAnotherSupplier" in method: <ul style="list-style-type: none"> • POST /gateway/notification/contract/list?first={integer}&count={integer}&sortOrder={ASC/DSC}
0.7.65	2022-08-25	Error 116 is returned in NTK (new supplier change) process: <ul style="list-style-type: none"> • POST /gateway/notification/contract
0.7.66	2022-08-26	Edited rule 606 and added 607 rule in method: <ul style="list-style-type: none"> • POST /gateway/notification/cancellation
0.7.67	2022-08-31	Restored the parameter objectNumbers into objectNumber in method: <ul style="list-style-type: none"> • POST /gateway/object/all/active/list?first={integer}&count={integer}&sortKey={string}&sortOrder={ASC/DSC}
0.7.68	2022-09-02	Edited 3001 error message in method: <ul style="list-style-type: none"> • POST /gateway/access-right
0.7.69	2022-09-07	Removed "Contract change notification controller"
0.7.70	2022-09-20	Added json field "meterAutomated" and edited 3 rule in method: <ul style="list-style-type: none"> • POST /gateway/declaration/reading/list?first={integer}&count={integer}&sortKey={string}&sortOrder={ASC/DSC}
0.7.71	2022-09-30	Added json field "timeZone" in method: <ul style="list-style-type: none"> • GET/gateway/order/{orderId}/report-obj
0.7.72	2022-10-03	Added new rule 8 in method:

		<ul style="list-style-type: none"> POST /gateway/notification/contract/object/supply-state
0.7.73	2022-10-04	<p>Added json field "orderParametersSearch" in method:</p> <ul style="list-style-type: none"> POST/gateway/order/list?first={integer}&count={integer}&sortKey={string}&sortOrder={ASC/DSC}
0.7.74	2022-10-10	<p>Added the new error message 2007:</p> <ul style="list-style-type: none"> POST/gateway/order/{hr15OrderShortName}
0.7.75	2022-10-11	<p>Added the new json field "productConsumptionType" in method:</p> <ul style="list-style-type: none"> GET/gateway/order/{orderId}/bill-2s2s-b2b
0.7.76	2022-10-17	<p>Added the new json field in method:</p> <ul style="list-style-type: none"> POST /gateway/object/all/active/list?first={integer}&count={integer}&sortKey={string}&sortOrder={ASC/DSC} <p>"metersAmount":"integer", "autoMetersAmount":"integer", "smartMeterInstallationDate":"date", "meterAutomated":"boolean", "automationSystem":"string"</p>
0.7.77	2022-10-18	<p>Added new methods:</p> <ul style="list-style-type: none"> POST/gateway/order/data-hr-15min-mtr-lvl-acr POST/gateway/order/data-hr-15min-obj-lvl-acr POST/gateway/order/data-sum-obj-lvl-acr POST /gateway/order/report-obj-acr GET /gateway/order/{orderId}/data-hr-15min-obj-lvl-acr?first={integer}&count={integer} GET /gateway/order/{orderId}/data-hr-15min-mtr-lvl-acr?first={integer}&count={integer} GET /gateway/order/{orderId}/report-obj-acr?first={integer}&count={integer} GET /gateway/order/{orderId}/data-sum-obj-lvl-acr?first={integer}&count={integer}
0.7.78	2022-10-24	<p>Added the new error message 2009:</p> <ul style="list-style-type: none"> POST/gateway/order/data-sum-obj-lvl-acr
0.7.79	2022-10-21	Added recommendations for SYNC API client
0.7.80	2022-10-31	<p>Added the new error message 320 in method:</p> <ul style="list-style-type: none"> POST /gateway/notification/contract
0.7.81	2022-11-03	<p>Added json field newPayoffMethod in methods:</p> <ul style="list-style-type: none"> POST /gateway/notification/contract/tariff-plan POST /gateway/notification/contract/tariff-plan/list??first={integer}&count={integer}&sortKey={string}&sortOrder={ASC/DSC} <p>Added json field payoffMethod in method:</p> <ul style="list-style-type: none"> POST /gateway/notification/contract/tariff-plan/list??first={integer}&count={integer}&sortKey={string}&sortOrder={ASC/DSC}
0.7.82	2022-11-30	<p>Changed 27, 28 rules in method:</p> <ul style="list-style-type: none"> POST /gateway/notification/contract
0.7.83	2022-12-01	Added new json field "tariffPlanChangeDate" in method:

		<ul style="list-style-type: none"> • POST /gateway/object/all/active/list?first={integer}&count={integer}&sortKey={string}&sortOrder={ASC/DSC}
0.7.84	2022-12-05	<p>Removed methods from documentation. Deprecated in the future, preliminary date 2023-02-14, methods:</p> <ul style="list-style-type: none"> • POST /reports/objects-data-pack?first={integer}&count={integer} • POST /reports/objects-data-pack-count
0.7.85	2023-01-11	<p>Changed 21 rule in method:</p> <ul style="list-style-type: none"> • POST /gateway/notification/contract
0.7.86	2023-01-17	<p>Removed 8 error in method:</p> <ul style="list-style-type: none"> • POST /gateway/notification/contract/object/supply-state
0.7.87	2023-01-18	<p>Removed method from documentation. Deprecated in the future, preliminary date 2023-07-18, method:</p> <ul style="list-style-type: none"> • POST /gateway/notification/contract/owner
0.7.88	2023-01-23	<p>Added new rule 2022 in method:</p> <ul style="list-style-type: none"> • GET/gateway/order/{orderId}/data-hr-15min-obj-lvl • GET/gateway/order/{orderId}/data-hr-15min-mtr-lvl • GET/gateway/order/{orderId}/data-hr-15min-obj-lvl-acr • GET/gateway/order/{orderId}/data-hr-15min-mtr-lvl-acr
0.7.89	2023-01-25	<p>Edited 53 rule and 42 error. Added new 54 rule and new 210 error. Method:</p> <ul style="list-style-type: none"> • POST /gateway/notification/contract <p>Added new 26 rule and 210 error. Method:</p> <ul style="list-style-type: none"> • POST /gateway/notification/contract/tariff-plan
0.7.90	2023-01-27	<p>Removed method from documentation:</p> <ul style="list-style-type: none"> • POST/gateway/contract/list?first={integer}&count={integer}&sortKey={string}&sortOrder={ASC/DSC}
0.7.91	2023-03-03	<p>Added json field "valueType" in methods:</p> <ul style="list-style-type: none"> • GET/gateway/order/{orderId}/data-hr-15min-obj-lvl • GET/gateway/order/{orderId}/data-hr-15min-mtr-lvl • GET /gateway/order/{orderId}/data-hr-15min-obj-lvl-acr • GET /gateway/order/{orderId}/data-hr-15min-mtr-lvl-acr
0.7.92	2023-03-03	<p>Added new json response fields in method POST /gateway/object/all/active/list</p> <ul style="list-style-type: none"> • ObjectLatestSupplyState <ul style="list-style-type: none"> ○ State ○ StateValidFrom ○ StateValidTo
0.7.93	2023-03-09	<ul style="list-style-type: none"> • Changed error message (rule No. 73, error code 320) in method POST /gateway/notification/contract • Changed error message (rule No. 24, error code 320) in method POST /gateway/notification/contract/tariff-plan

0.7.94	2023-03-10	<ul style="list-style-type: none"> Updated rule description (rule No. 21, error code 131) in method POST /gateway/notification/contract
0.7.95	2023-03-14	Removed controller “Supplier change notification controller”. Deprecated in 2023-03-14
0.7.96	2023-03-20	Added new rule and 608 error code. Method: POST /gateway/notification/cancellation
0.7.97	2023-03-30	<p>Added new payoffMethod [S – kWh – PP recovered electricity] in methods:</p> <ul style="list-style-type: none"> POST /gateway/notification/contract/list POST /gateway/notification/contract POST /gateway/notification/contract/tarif-plan/list?first={integer}&count={integer}&sortKey={string}&sortOrder={ASC/DSC} POST /gateway/object/my/active/list POST /gateway/object/all/active/list <p>Added new newpayoffMethod [S – kWh – PP recovered electricity] in methods:</p> <ul style="list-style-type: none"> POST /gateway/notification/contract/tarif-plan/list?first={integer}&count={integer}&sortKey={string}&sortOrder={ASC/DSC} POST /gateway/notification/contract/tariff-plan
0.7.99	2023-04-06	<p>Added new json response fields: consumptionAverage consumptionAverageCalculationDate consumptionAverageCalculationMonthsCount</p> <p>In methods: POST /gateway/object/my/active/list POST /gateway/object/all/active/list GET/gateway/order/{orderId}/report-obj GET /gateway/order/{orderId}/report-obj-acr</p>
0.8.0	2023-04-17	Removed 73 rule, 320 error. Method: POST /gateway/notification/contract
0.8.1	2023-05-03	Added new rules (150 and 151 error code). Method: POST /gateway/notification/contract
0.8.2	2023-05-03	Added new rule 2022 in method: GET/gateway/order/{orderId}/bill-bss-b2c GET/gateway/order/{orderId}/bill-bss-b2b
0.8.3	2023-05-04	Added recommendations for ASYNC API client
0.8.4	2023-05-05	Added new json response field in method GET/gateway/order/{orderId}/report-obj supplierChangeNotificationSubmittedDate
0.8.5	2023-05-05	Added the new json field: powerPlantObjectNumber in methods: POST /gateway/object/all/active/list

		POST /gateway/object/my/active/list
0.8.6	2023-05-11	Changed json response field obligation to not required: <ul style="list-style-type: none"> productType In method: <ul style="list-style-type: none"> GET /gateway/order/{orderId}/data-sum-obj-lvl-acr
0.8.7	2023-05-12	Added new rule 75, error code 118 in method: <ul style="list-style-type: none"> POST /gateway/notification/contract
0.8.8	2023-05-18	Added recommendations for JSON request logic (6.3 JSON request logic) and will be released new v2 versions in methods: <ul style="list-style-type: none"> POST/gateway/order/v2/data-hr-15min-mtr-lvl POST/gateway/order/v2/data-hr-15min-obj-lvl POST/gateway/order/v2/data-hr-15min-mtr-lvl-acr POST/gateway/order/v2/data-hr-15min-obj-lvl-acr
0.8.9	2023-05-18	Edited 23 rule in the method: <ul style="list-style-type: none"> POST /gateway/notification/contract
0.9.0	2023-05-18	Edited 419 rule in the method: <ul style="list-style-type: none"> POST /gateway/notification/contract/contact
0.9.1	2023-05-18	Edited 3006 rule in the method: <ul style="list-style-type: none"> POST /gateway/access-right
0.9.2	2023-05-18	Removed 70 error in method: <ul style="list-style-type: none"> POST /gateway/notification/contract/termination
0.9.3	2023-05-18	Added new rule and 609 error code. Method: <ul style="list-style-type: none"> POST /gateway/notification/cancellation
0.9.4	2023-05-26	Merged rules error codes 150 and 151 (new rule is with error code 150) in method: <ul style="list-style-type: none"> POST /gateway/notification/contract
0.9.5	2023-05-26	Removed Access rights controller from documentation
0.9.6	2023-05-29	Removed Data order controller from documentation
0.9.7	2023-06-05	Added the new json fields: <ul style="list-style-type: none"> lastCheckedReadingValue lastCheckedReadingValueDate in methods: <ul style="list-style-type: none"> GET /gateway/supplier/v3/get-declaration-data POST /gateway/declaration/reading/list
0.9.8	2023-06-14	Edited 603 rule in method: <ul style="list-style-type: none"> POST /gateway/notification/cancellation
0.9.9	2023-06-21	Edited 20212 rule in method:

		<ul style="list-style-type: none"> • POST/gateway/order/v2/data-hr-15min-mtr-lvl • POST/gateway/order/v2/data-hr-15min-mtr-lvl-acr • POST/gateway/order/v2/data-hr-15min-obj-lvl-acr • POST/gateway/order/data-sum-obj-lvl-acr • POST/gateway/order/v2/data-hr-15min-obj-lvl • POST/gateway/order/{orderType}
0.10.1	2023-06-21	<p>Removed 1001 rule in methods:</p> <ul style="list-style-type: none"> • POST /gateway/notification/contract/list • POST /gateway/notification/contract/termination/list • POST /gateway/notification/contract/object/supply-state/list • POST /gateway/notification/cancellation/list <p>Added 1007 rule in methods:</p> <ul style="list-style-type: none"> • POST /gateway/notification/v2/contract/list • POST /gateway/notification/v2/contract/termination/list • POST /gateway/notification/v2/contract/object/supply-state/list • POST /gateway/notification/v2/cancellation/list • POST /gateway/notification/v2/contract/contact/list • POST /gateway/notification/v2/contract/tariff-plan/list • POST /gateway/access-right/v2/list
0.10.2	2023-06-23	<p>Added recommendations for:</p> <ul style="list-style-type: none"> • change notifications API client • meter reading declaration API client
0.10.3	2023-06-28	<p>Added recommendations for:</p> <ul style="list-style-type: none"> • access rights API client
0.10.4	2023-06-29	<p>Added 322 rule in method:</p> <ul style="list-style-type: none"> • POST /gateway/notification/contract/tariff-plan
0.10.5	2023-06-30	<p>Added 2023 rule in methods:</p> <ul style="list-style-type: none"> • POST/gateway/order/v2/data-hr-15min-mtr-lvl • POST/gateway/order/v2/data-hr-15min-obj-lvl • POST/gateway/order/v2/data-hr-15min-mtr-lvl-acr • POST/gateway/order/v2/data-hr-15min-obj-lvl-acr
0.10.6	2023-07-10	<p>Added the new json response field:</p> <ul style="list-style-type: none"> • generatingGroup • generatingObjectPriorityGroup <p>in methods:</p> <ul style="list-style-type: none"> • GET/gateway/order/{orderId}/bill-bss-b2c • GET/gateway/order/{orderId}/bill-bss-b2b

		<ul style="list-style-type: none"> • GET/gateway/order/{orderId}/bill-2s2s-b2b • POST /reports/accounting-data-pack-b2c?first={integer}&count={integer} • POST /reports/accounting-data-pack-b2b-meters-level?first={integer}&count={integer}
0.10.7	2023-07-11	Added new statistic controller.
0.10.8	2023-08-01	<p>Updated 314 rule description in method:</p> <ul style="list-style-type: none"> • POST /gateway/notification/contract <p>Updated 322 rule description in method:</p> <ul style="list-style-type: none"> • POST /gateway/notification/contract/tariff-plan
0.10.9	2023-08-02	<p>In method POST/gateway/access-right/v2/list, changed request attributes data type from date → dateTime:</p> <ul style="list-style-type: none"> • accessRightValidFrom • accessRightValidTo <p>In method POST /gateway/notification/v2/contract/list, changed attributes data type from dateTime → date:</p> <ul style="list-style-type: none"> • contractStartFrom (request) • contractStartTo (request) • oldContractInfo.auctionDate (response) <p>In method POST /gateway/notification/v2/contract/termination/list, changed attributes data type from dateTime → date:</p> <ul style="list-style-type: none"> • contractTerminationDateFrom (request) • contractTerminationDateTo (request)
0.10.10	2023-08-02	<p>Added v2 version for method:</p> <ul style="list-style-type: none"> • POST/gateway/order/v2/list <p>In method POST/gateway/order/v2/list, changed request attributes data type from date -> datetime:</p> <ul style="list-style-type: none"> • submittedDateFrom

		<ul style="list-style-type: none"> submittedDateTo
0.10.11	2023-08-08	<p>Added response fiels: "payoffMethodChangeDate": "date"</p> <ul style="list-style-type: none"> POST /gateway/object/my/active/list?first={integer}&count={integer}&sortKey={string}&sortOrder={ASC/DSC} POST /gateway/object/all/active/list?first={integer}&count={integer}&sortKey={string}&sortOrder={ASC/DSC}
0.10.12	2023-08-23	<p>Updated error message text with error code 8.</p> <p>In methods:</p> <ul style="list-style-type: none"> POST /gateway/notification/contract POST /gateway/notification/contract/termination POST /gateway/notification/contract/tariff-plan POST /gateway/access-right
0.10.13	2023-08-25	<p>Added 1010 rule in methods:</p> <ul style="list-style-type: none"> POST /gateway/notification/v2/contract/tarif-plan/list POST /gateway/notification/v2/contract/contact/list POST /gateway/notification/v2/contract/termination/list POST /gateway/notification/v2/contract/list POST /gateway/notification/v2/contract/object/supply-state/list POST /gateway/notification/v2/cancellation/list
0.10.14	2023-09-06	<p>In JSON request changed attribute name (from status to latestStatus) and added multi select. In methods:</p> <ul style="list-style-type: none"> POST /gateway/notification/v2/contract/contact/list POST /gateway/notification/v2/contract/termination/list POST /gateway/notification/v2/contract/tariff-plan/list <p>In JSON request changed attribute name (from status to latestStatus). In methods:</p> <ul style="list-style-type: none"> POST /gateway/notification/v2/contract/list POST /gateway/notification/v2/contract/object/supply-state/list POST /gateway/notification/v2/cancellation/list

0.10.15	2023-09-06	Deleted meterAccountingType value PARTIAL in method: <ul style="list-style-type: none"> • GET /gateway/statistic/list
0.10.16	2023-09-07	The list is constructed from the powerPlantObjectNumber and powerPlantType fields in these methods: <ul style="list-style-type: none"> • POST /gateway/object/v2/my/active/list • POST /gateway/object/v2/all/active/list Upgrading these methods to v2.
0.10.17	2023-09-07	Added response fields: "payoffMethodChangeDate": "date" in methods: <ul style="list-style-type: none"> • GET/gateway/order/{orderId}/report-obj • GET/gateway/order/{orderId}/report-obj-acr
0.10.18	2023-09-08	Updated rule 608 in method: <ul style="list-style-type: none"> • POST /gateway/notification/cancellation
0.10.19	2023-09-12	The list is constructed from the powerPlantObjectNumber and powerPlantType fields in these methods: <ul style="list-style-type: none"> • GET/gateway/order/{orderId}/report-obj • GET/gateway/order/{orderId}/report-obj-acr Upgrading these methods to v2.
0.10.20	2023-09-13	Json response field names changed from uppercase to lowercase: <ul style="list-style-type: none"> • GET/gateway/order/{orderId}/bill-bss-b2c • GET/gateway/order/{orderId}/bill-bss-b2b
0.10.21	2023-09-13	Added new statistics names (cancellation of SK and STK notifications) in method: <ul style="list-style-type: none"> • GET/gateway/statistic/list
0.10.22	2023-09-13	Added new statistic name (cancellation of supply states notifications with reason disconnection due to debt) in method: <ul style="list-style-type: none"> • GET/gateway/statistic/list

0.10.23	2023-09-15	Added new JSON response field sociallyVulnerable in method: <ul style="list-style-type: none"> • GET/gateway/order/{orderId}/report-obj
0.10.24	2023-09-20	Added new JSON response field generatingObjectPower in method: <ul style="list-style-type: none"> • GET/gateway/order/v2/{orderId}/report-obj • GET/gateway/order/v2/{orderId}/report-obj-acr • POST /gateway/object/v2/my/active/list • POST /gateway/object/v2/all/active/list
0.10.25	2023-09-26	Added new rules with 611, 612 error codes in method: <ul style="list-style-type: none"> • POST /gateway/notification/cancellation Updated error types in method: <ul style="list-style-type: none"> • POST /gateway/notification/v2/cancellation/list
0.10.26	2023-10-05	Changed error code from 2004 to 1010 and error code 1002 is merged with error code 2005 (2005 deleted) in method: <ul style="list-style-type: none"> • POST/gateway/order/v2/list
0.10.27	2023-10-27	JSON request fixed by JSON request logic rules and added v2 version for method: <ul style="list-style-type: none"> • POST /gateway/declaration/reading/list
0.10.28	2023-10-27	JSON request fixed by JSON request logic rules and added v2 version in these methods: <ul style="list-style-type: none"> • POST/gateway/order/{orderType} • POST /gateway/order/report-obj-acr
0.10.29	2023-10-27	Rule with 1002 code changed error message (dateFrom, dateTo words separated).
0.10.30	2023-10-27	Changed error message with 1003 error code in methods: <ul style="list-style-type: none"> • POST /gateway/notification/contract

		<ul style="list-style-type: none"> • POST /gateway/notification/contract/termination • POST /gateway/notification/contract/object/supply-state • POST /gateway/notification/cancellation • POST /gateway/notification/contract/tariff-plan • POST /gateway/notification/contract/contact
0.10.31	2023-10-27	<p>In JSON request changed attribute name (from latestStatus to latestStatuses). In methods:</p> <ul style="list-style-type: none"> • POST /gateway/notification/v2/contract/contact/list • POST /gateway/notification/v2/contract/termination/list • POST /gateway/notification/v2/contract/tariff-plan/list • POST /gateway/notification/v2/contract/list • POST /gateway/notification/v2/contract/object/supply-state/list • POST /gateway/notification/v2/cancellation/list
0.10.32	2023-10-27	<p>In JSON request changed attribute name (from status to latestStatuses) and added multi select. In method:</p> <ul style="list-style-type: none"> • POST/gateway/order/v2/list
0.10.33	2023-10-31	Updated recommendations for JSON request logic with boolean values.
0.10.34	2023-11-08	<p>Changed deprecated date from 2023-11-14 to 2024-02-13 in methods:</p> <ul style="list-style-type: none"> • POST /reports/accounting-data-pack-b2c • POST /reports/accounting-data-pack-b2c-count • POST /reports/accounting-data-pack-b2b-meters-level • POST /reports/accounting-data-pack-b2b-meters-level-count
0.10.35	2023-11-14	<p>Deleted rule with error code 1001 in method:</p> <ul style="list-style-type: none"> • POST/gateway/access-right/v2/list
0.10.36	2023-12-08	<p>Updated rule description and error message with error code 2011 and added 2025 error code in method:</p> <ul style="list-style-type: none"> • POST/gateway/order/v2/{orderType}
0.10.37	2024-01-12	The list is constructed (response) from the powerPlantObjectNumber, powerPlantType, generatingPower fields in method:

		<ul style="list-style-type: none"> • POST /gateway/access-right/v2/list
0.10.38	2024-01-19	<p>Updated 302 rule description in method:</p> <ul style="list-style-type: none"> • POST /gateway/notification/contract/tariff-plan
0.10.39	2024-02-13	<p>Added new methods:</p> <ul style="list-style-type: none"> • POST/gateway/order/data-hr-15min-history-changes • GET/gateway/order/{orderId}/data-hr-15min-history-changes <p>In method POST/gateway/order/v2/data-hr-15min-obj-lvl:</p> <ul style="list-style-type: none"> • Added new netBilling attributes intervalData, intervalDataRecalculation, intervalDataDetailed in JSON request • Removed rule with error code 1005 • Added new rules with error codes 2026, 2027, 2028 <p>In methods GET/gateway/order/{orderId}/data-hr-15min-obj-lvl and GET/gateway/order/{orderId}/data-hr-15min-obj-lvl-acr:</p> <ul style="list-style-type: none"> • Added new attributes graphVersion, powerPlantObjectNumber, powerPlantType, usageType in JSON response <p>In method POST/gateway/order/v2/data-hr-15min-obj-lvl-acr:</p> <ul style="list-style-type: none"> • Added new netBilling attributes intervalData, intervalDataDetailed in JSON request • Removed rule with error code 1005 • Added new rules with error codes 2028, 2029
0.10.40	2024-02-15	<p>Removed methods:</p> <ul style="list-style-type: none"> • POST /reports/accounting-data-pack-b2c • POST /reports/accounting-data-pack-b2c-count • POST /reports/accounting-data-pack-b2b-meters-level • POST /reports/accounting-data-pack-b2b-meters-level-count
0.10.41	2024-02-27	<p>In method POST /gateway/notification/contract:</p>

		<ul style="list-style-type: none"> • Added list meterDeclarations : [] in JSON request • Added new rules with error codes 152, 153, 154, 155, 156, 157, 158, 159, 160, 164 <p>In method POST /gateway/notification/v2/contract/list:</p> <ul style="list-style-type: none"> • Added list meterDeclarations : [] in JSON response • Added new attribute declared in JSON request <p>In method POST /gateway/notification/contract/termination:</p> <ul style="list-style-type: none"> • Added list meterDeclarations : [] in JSON request • Added new rules with error codes 152, 153, 154, 155, 156, 157, 158, 159, 161, 164 <p>In method POST /gateway/notification/v2/contract/termination/list:</p> <ul style="list-style-type: none"> • Added list meterDeclarations : [] in JSON response • Added new attribute declared in JSON request <p>In method POST /gateway/object/v2/my/active/list:</p> <ul style="list-style-type: none"> • Added scales list in JSON response <p>In method POST /gateway/object/v2/all/active/list:</p> <ul style="list-style-type: none"> • Added scales list and meterScaleLength in JSON response
0.10.42	2024-02-29	<p>Added new methods:</p> <ul style="list-style-type: none"> • POST /gateway/order/balance-data • GET /gateway/order/{orderId}/balance-data <p>In the method POST/gateway/order/v2/list</p> <ul style="list-style-type: none"> • Added new orderType "balance-data"

0.10.43	2024-03-04	<p>Added new methods:</p> <ul style="list-style-type: none"> • POST /gateway/order/balance-by-generation-type • GET /gateway/order/{orderId}/balance-by-generation-type <p>In the method POST/gateway/order/v2/list</p> <ul style="list-style-type: none"> • Added new orderType "balance-by-generation-type"
0.10.44	2024-03-07	<p>Added new rules with error codes 423, 424 in method:</p> <ul style="list-style-type: none"> • POST /gateway/notification/contract/contact <p>Added new rules with error codes 161, 162 in method:</p> <ul style="list-style-type: none"> • POST /gateway/notification/contract
0.10.45	2024-03-08	<p>Added new statistic names in service ORDERS for balance reports in method:</p> <ul style="list-style-type: none"> • GET/gateway/statistic/list

Note: Changes in table marked in white are already deployed, marked in green will be deployed in near future.

2. Preface

The Common Data Exchange Platform (hereinafter referred as *DH Platform*) Gateway is a component enabling independent electricity suppliers to directly access DH Platform from within their IT systems and thus helps automate the following business processes:

- Obtaining electricity consumption history data with the purpose of providing commercial proposals for the potential clients – residential and industrial electricity consumers
- Providing information to Distribution System Operator about the new contracts with the clients who have switched their supplier.

DH Gateway provides open standards-based interfaces allowing independent suppliers themselves (or with outside assistance) integrate their IT systems with DH Platform.

This document provides technical information on DH Gateway interfaces which is needed to integrate suppliers' information systems with DH Platform.

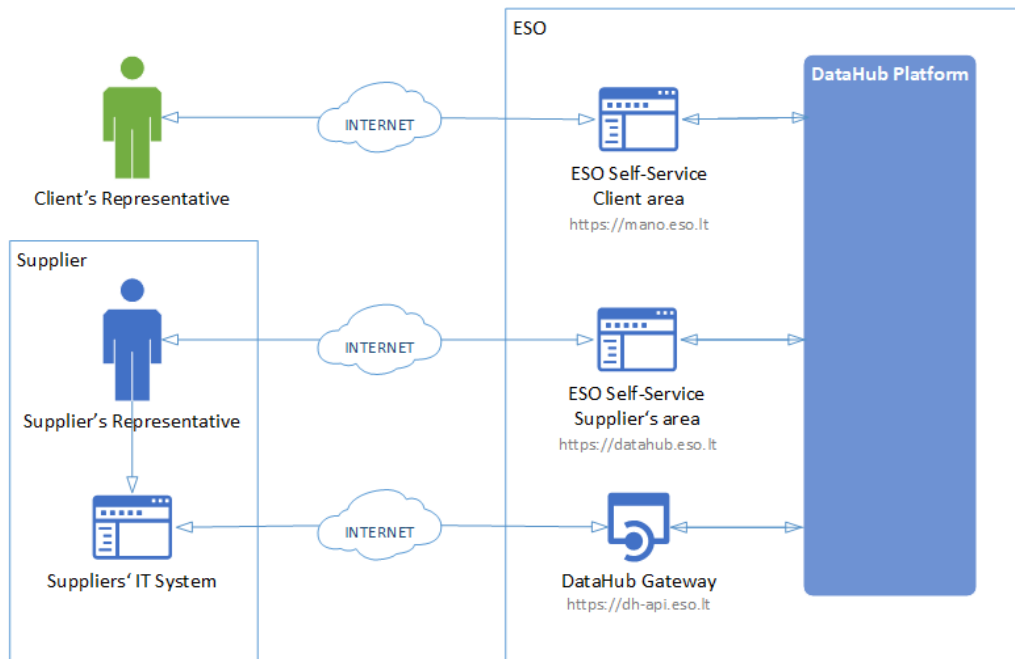

3. Definitions and abbreviations

Definition / abbreviation	Description
DH Gateway	DH Platform component enabling independent supplier's IT systems to directly access the platform and achieve a higher level degree of process automation.
DH, DH Platform	Common Data Exchange Platform.
Client	A household or legal person using electricity for the needs of the holding or business.
Client's Representative	A household person or his representative Representative of a legal entity (i.e. employee of a legal entity)
DSO, ESO	Energy distribution system operator – AB „Energijos skirstymo operatorius“
Object	A site where electricity consumption takes place.
Supplier	Independent electricity supplier.
Supplier's Representative	Independent electricity supplier's employee representing the supplier.

4. Environments

There are two DH Gateway environments the supplier might access:

- “Sandbox” environment
- Production environment

DH Sandbox environment made of Mock API Gateway with mock requests and responses (scenarios). There are no connection to database or any data source, all possible requests and answers are hard-coded into mock API source code and has no any data selection logic or rules. This data is real depersonalized data from DSO customers. Sandbox requests and responses scenarios will be provided in additional document and it should be used just for preparation to integrate with DH production API environment or testing purposes.

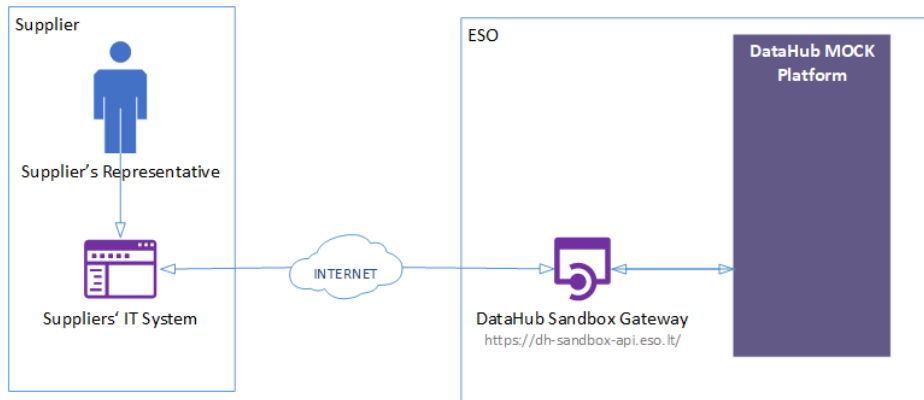

DH Platform also has WEB interface, which is connected to DH Production Gateway. All environments are provided in the table:

Environment	Link	Swagger Link	WEB Interface
Production	https://dh-api.eso.it	https://dh-api.eso.it/swagger-ui.html	https://datahub.eso.it/
Sandbox	https://dh-sandbox-api.eso.it	https://dh-sandbox-api.eso.it/swagger-ui.html	-
Sandbox v2	https://dh-sandbox-api-v2.eso.it/	https://dh-sandbox-api-v2.eso.it/swagger-ui.html#/	-

5. Suppliers' digital certificates

In both the testing and production environments of the DH Gateway component, the identity of the supplier is established using a TOKEN, which the supplier's information system must provide each time the DH Gateway network service is called.

To get started:

1. The DSO responsible person sends the JWT key (JSON Web Token) to be used with each request to the DH API.
2. To make requests to the DH Gateway API - the TOKEN submission in the case of cUrl takes place.

```
curl --header 'Authorization: Bearer key_received_from_DSO' https://dh-sandbox-api.eso.lt/data/data-orders/1/data
```

6. Recommendation for API client

6.1 SYNC

Sequential approach with pagination:

Should be default option

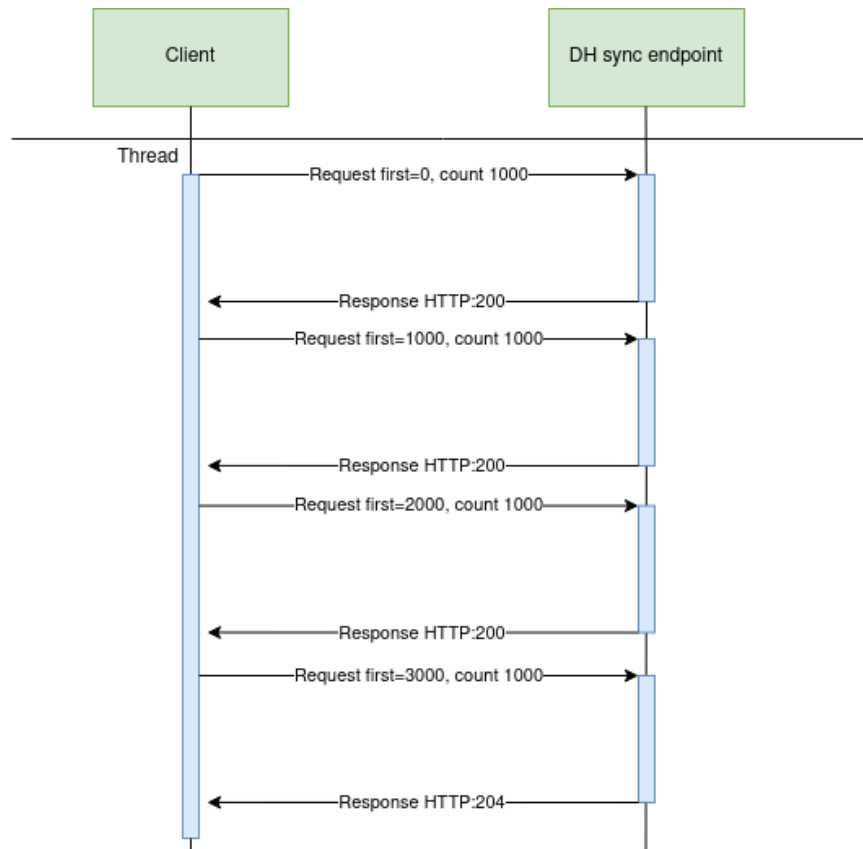

Parallel approach with pagination

Could be used than import time is not reasonable. But parallel requests should be limited.

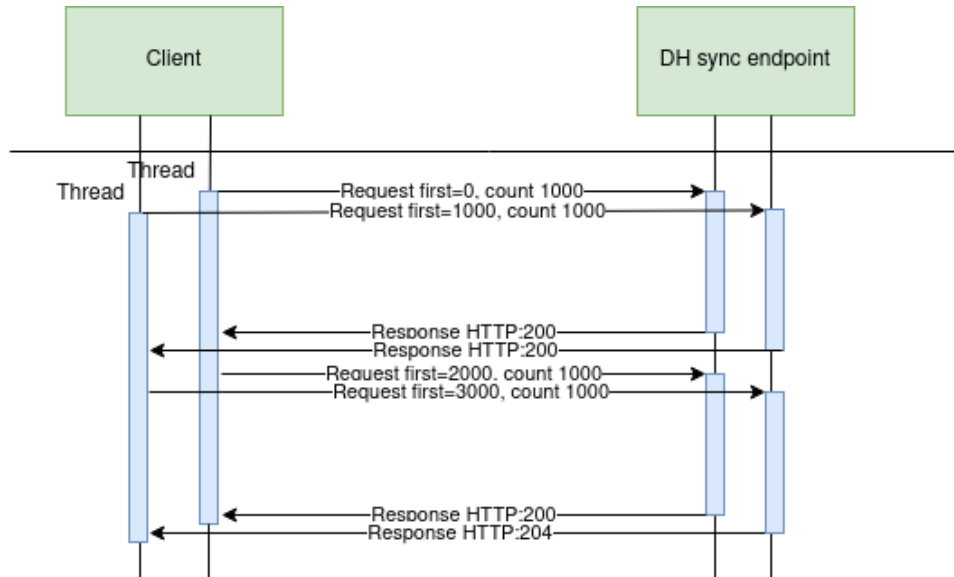

Recommendations for DH client:

1. Parameter for page size control
2. Parameter for parallel thread amount control
3. Sequentially process should be default, but if import takes too much time, parallel process could be used but with max 3 threads.
4. Page size can be calculated by formula $PS = PST/THRA$, where PS - page size, PST - page size with which request takes less than 15 seconds to execute, THRA - thread amount. But not more than 10 000 records.
5. Retry on HTTP statuses: 429, 5xx
6. Retry should restart failed request only (not whole import process)
7. Retry interval should be not less than 5 seconds.
8. Import process should be able to continue process after failure

Motivation to have these features

1. Performance issues can arise accidentally and solving them can take some time. So, during performance problem page size and thread amount control could help.
2. DH has planned and unplanned deployments also can be incidents and during them DH services might be unavailable. In this case from the client side is nice to have a fallback process which retries failed requests and continues the process after service becomes available again.
3. In the future throttling by independent supplier will be introduced and some of the requests could end up with http status 429 (too many requests) so retry process also will be helpful here.

6.2 ASYNC

Async pattern is mainly used for data orders: <https://dh-api.eso.lt/swagger-ui.html#/public-order-controller>

Client side should implement following process with steps:

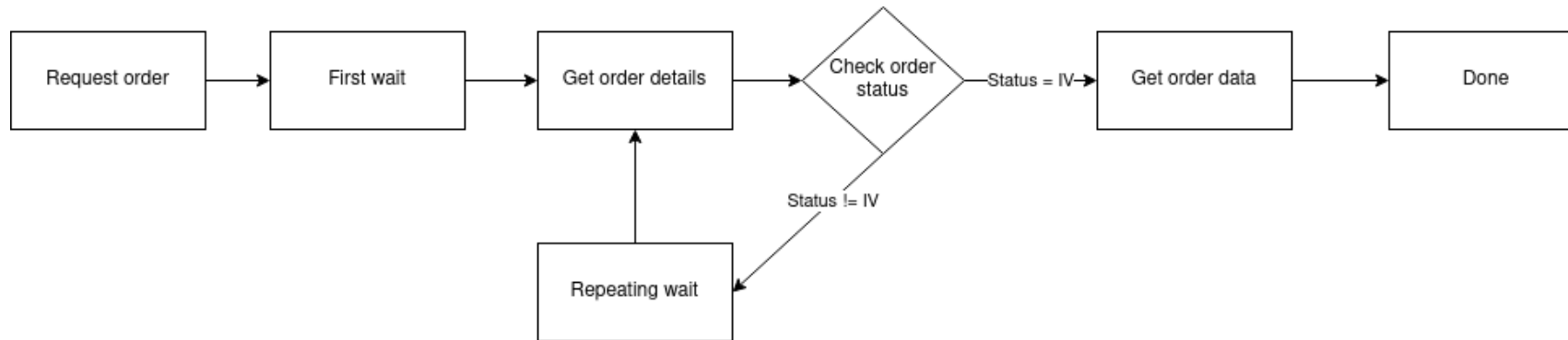

Step descriptions

Step name	Description	End-point	Request example	Response example
Request order	Submit new data order. Request will return order id which will be used in other steps for getting order details and order data.	POST /gateway/order/ yyyyyyyyyy where yyyyyyyyyy is order type: <ul style="list-style-type: none"> • bill-2s2s-b2b • bill-bss-b2b • bill-bss-b2c • report-obj • data-hr-15min-mtr-lvl • data-hr-15min-mtr-lvl-acr • data-hr-15min-obj-lvl • data-hr-15min-obj-lvl-acr • data-sum-obj-lvl-acr • report-obj-acr 	POST /gateway/order/report-obj-acr Body: { "objectNumbers": ["111111111111", "2222222222"] }	HTTP status 201 { "orderId": 10000001 }
First wait	Wait for some period of time after order submission.			

	<p>This step is needed because after order request it takes some time to process it and there is no reason to try get status immediately after order submission.</p> <p>First wait duration depends on order type and parameters. If order collects more data it can take minutes to prepare data.</p> <p>For duration recommendations look at 6.2.3 Recommendations.</p>			
Get order details	<p>Request to get order details. This request is needed to get order latest status which is stored in field "latestStatus".</p> <p>Possible values for "latestStatus":</p> <ul style="list-style-type: none"> • P - Submitted order • V - Order in progress • IV - Order is finished and data are prepared • K - Order has errors 	POST /gateway/order/list	<pre>POST /gateway/order/list { "orderId": 10000001 }</pre>	<p>HTTP status 200</p> <pre>[{ "orderId": 10000001, "auto": false, "dateFrom": "2023-04-17", "dateTo": "2023-04-17", "expireDate": "2023-04-18T14:31:27.990Z", "latestStatus": "V", "orderParameters": "{\"objectNumbers\":[\"111111111111\", \"2222222222\"]}", "orderType": "report-obj-acr", "statusDate": "2023-04-17T14:31:27.990Z", "submittedDate": "2023-04-17T14:31:27.990Z", "userName": "PUBLIC" }]</pre>

]
Check order status	Logic operation to check order "latestStatus" field value. If value equals to "IV" it means that order data is prepared. Otherwise order data is not ready algorithm should go to step "Repeating wait".			
Repeating wait	Wait for some period of time after order status check when status was not equal to "IV". This step is needed because repetitive status check without wait can do unneeded load to DH system. For duration recommendations look at 6.2.3 Recommendations.			
Get order data	Get order data. Note: If order has too many data then pagination should be used. Default and max page size is 10 000 records (usually it's objects). How to get data described in Sync (6.1 SYNC).	GET /gateway/order/ zzzzzzzz / yyyyyyyy yy?first=oooooo&count=ssssss where zzzzzzzz is order Id oooooo is offset position ssssss is page size yyyyyyyy is order type: <ul style="list-style-type: none"> • bill-2s2s-b2b • bill-bss-b2b • bill-bss-b2c • report-obj • data-hr-15min-mtr-lvl • data-hr-15min-mtr-lvl-acr • data-hr-15min-obj-lvl • data-hr-15min-obj-lvl-acr • data-sum-obj-lvl-acr • report-obj-acr 	GET /gateway/order/10000001/ report-obj- acr?first=0&count=10000	HTTP status 200 with order data in JSON format. If order content is empty get method will return HTTP status 400 with message {"code": 2018, "text": "There is no data for the selected search parameters, the response is empty."}

6.2.1 DataHub order processing retry policy

If any issues appears during order data processing stage the process stops and order gets status K. DH uses retry policy for all orders with status K.

- Retries order process after 5 minutes
- Retries order process 300 times
- For failed orders retry policy will be working in total 25 hours (5 min * 300).
- Retry policy will stop work after 25 hours and order will be left with status K.

This is needed because issues can appear in data preparation stage of couple reasons:

- DH technical problem - For example one of DH integrations was down or contract was changed, data integrity violations and etc
- Incompatible business logic - For example order got into not defined use case and use case should be adopted to order.

In most cases order processing retry will solve problem. But there are cases like "Incompatible business logic" when additional human interaction is needed to finish order job. We are tracking such an orders and fixing them, but fixing might take some hours or even days. So, some orders might not be completed and left in status K.

6.2.2 Order status flows

There are three possible order status flows:

Flow	Description
P → V → IV	This is normal status flow.
P → V → K → IV	This is flow when issues appear during data preparation, but later problem was fixed.
P → V → K	This is flow when issues appear during data preparation and problem was not fixed during DH retry policy time.

Order execution duration depends on mutiply factors:

- Order type - different order types uses different integration services some of them are faster some of them are slower.
- Order parameters - order parameters describes how much data will be generated. Bigger order periods and bigger object quantity will be generated longer.
- Order quantity in queue. If independent supplier creates too much orders they will be generated parallely and will take more time to finish them all.

- Failures - Errors during order data preparation will trigger retry policy so order generation will take more time as usually. Some times it will be not generated at all.

6.2.3 Recommendations

1. For better performance "Request order" can be implemented as seprate process which is able to create multiple orders.
2. For better performance "Get order details" can be implemented as seprate process which is able to get details of multiple orders.
3. For better performance "Get order data" can be implemented as seprate process which is able to get order data of multiple orders.
4. For better performance process paralelization could be used but with max 3 threads.
5. Any HTTP request which returns 5xx status can be retried.
6. Any HTTP request which returns 4xx status should stop process because where are buiness error and manual handling should be used. Except for the step "Get order data" and error "code": 2018, "text": "There is no data for the selected search parameters, the response is empty." It means that order data preparation is finished and order is empty.
7. Step "Request order" and others steps should have seprate retries. Get order data on failure should not trigger Request order one more time.
8. It's up to client to decide how long the "First wait" duration can be but it shouldn't be less than 1 second.
9. It's up to client to decide how long the "Repeating wait" duration can be but it shouldn't be less than 1 second.
10. Use fixed number of times for status check. After 25 hours DH order retry policy will stop working and order will be left in status K. So it reasonable to have number of times equal ((25 hours) / ("Repeating wait" duration in hours)).
11. Do not recreate orders when order got status K. Datahub retry policy will tray to geretate it later or DH team member interation is needed to finish order. Client side solutions will not help to solve status K.
12. For the step "Get order data" use Sync (6.1 SYNC).

6.3 JSON request logic

JSON field usage in requests by type:

Type	Example	Is value provided	Request result
Integer	contractObjectBsId: null	No	All objects
Integer	contractObjectBsId: 4587125	Yes	Object with object in contract ID 4587125
Integer	contractObjectBsId: ""	Yes	Framework validation error because provided value is not matching Integer format.
DateTime	contractStart: null	No	All objects
DateTime	contractStart: ""	Yes	Framework validation error because provided value is not matchig date format.
DateTime	contractStart: "2023-01-01"	Yes	Objects which has contract start date greater than 2023-01-01

Type	Example	Is value provided	Request result
String	personCode: null	No	All objects
String	personCode: ""	Yes	Empty list because person with empty person code does not exists
String	personCode: "37878787878"	Yes	Objects which owner is person with code 37878787878
List	objectNumbers: null	No	All objects
List	objectNumbers: []	Yes	Empty list because provided objectNumbers list is not matchig any object number.
List	objectNumbers: [""] arba objectNumbers: ["" , ""]	Yes	Empty list because provided objectNumbers list is not matchig any object number.
List	objectNumbers: [null] arba objectNumbers: [null, null]	Yes	Empty list because provided objectNumbers list is not matchig any object number.
List	objectNumbers: ["56545654"] arba objectNumbers: ["56545654", "76545654"]	Yes	Objects with numbers 56545654 or 76545654.
Boolean	hasAutoMeters: null	No	All objects, because criteria was not given.
Boolean	hasAutoMeters: ""		Validation error, because invalid booblean value was given.
Boolean	hasAutoMeters: "NOT BOOLEAN"	No	Validation error, because invalid booblean value was given.
Boolean	hasAutoMeters: "true"	Yes	Objects which has automated meters.

If field value is not provided then field criteria should't be added to query and all list should be returned.

6.4 Change notifications

Modules of change notification is everything about changed data in DH. According changing data there are multiple notification types;

- Contract - for changing contract object owner (SK) or for changing independent supplier (NTK) or both (STK).
- Contract contact - for changing contract or contract object's contacts.
- Contract object supply state - for disconnecting/ connecting (changing supply state).
- Contract tariff plan - for changing tariff plan.
- Contract termination - for terminating active contract.

- Notification cancelation - for cancelation previously created notification which was already sent to the source system. Currently it's possible to cancel only NTK notifications. In the near future will be possible to cancel supply state notifications with the debt reason and STK notifications.

Main activities for all notifications are only three:

1. Register notification.
2. Track status.
3. Cancel notification

6.4.1 Register notification

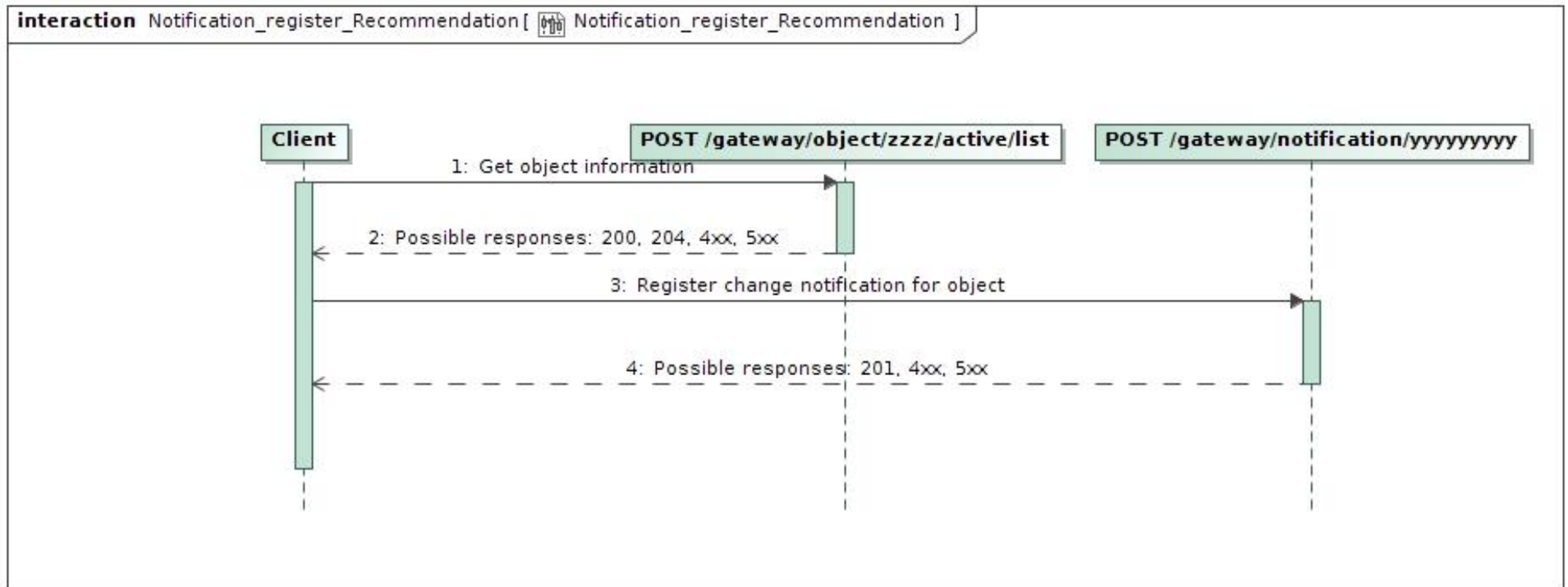

Some notes:

- zzzz - possible values are **[all, my]** depending on notification type.
- yyyyyyyyy - is any notification type like: contract, supply-state, termination and etc.
- For registering change notification some object information is needed, so it's reasonable to call object list before creating posting change notification.

- It is possible to register one notification with one request.
- Mostly one notification can contain multiple objects. Also, all objects should belong to the same contract. But in some cases, one notification can contain only one object. For example, supply state notification always has one object.
- For getting object information possible response http statuses might be 200 - when object was found, 204 - when object was not found, 4xx - when there are authentication problems or business validation rule was violated. 5xx - when there are service errors like service was shut down for maintenance purpose
- For registering notification possible response http statuses might be 201 - when everything went well, 4xx - when there are authentication problems or business validation rule was violated, 5xx - when there are service errors like service was shut down for maintenance purpose.

6.4.2 Track status

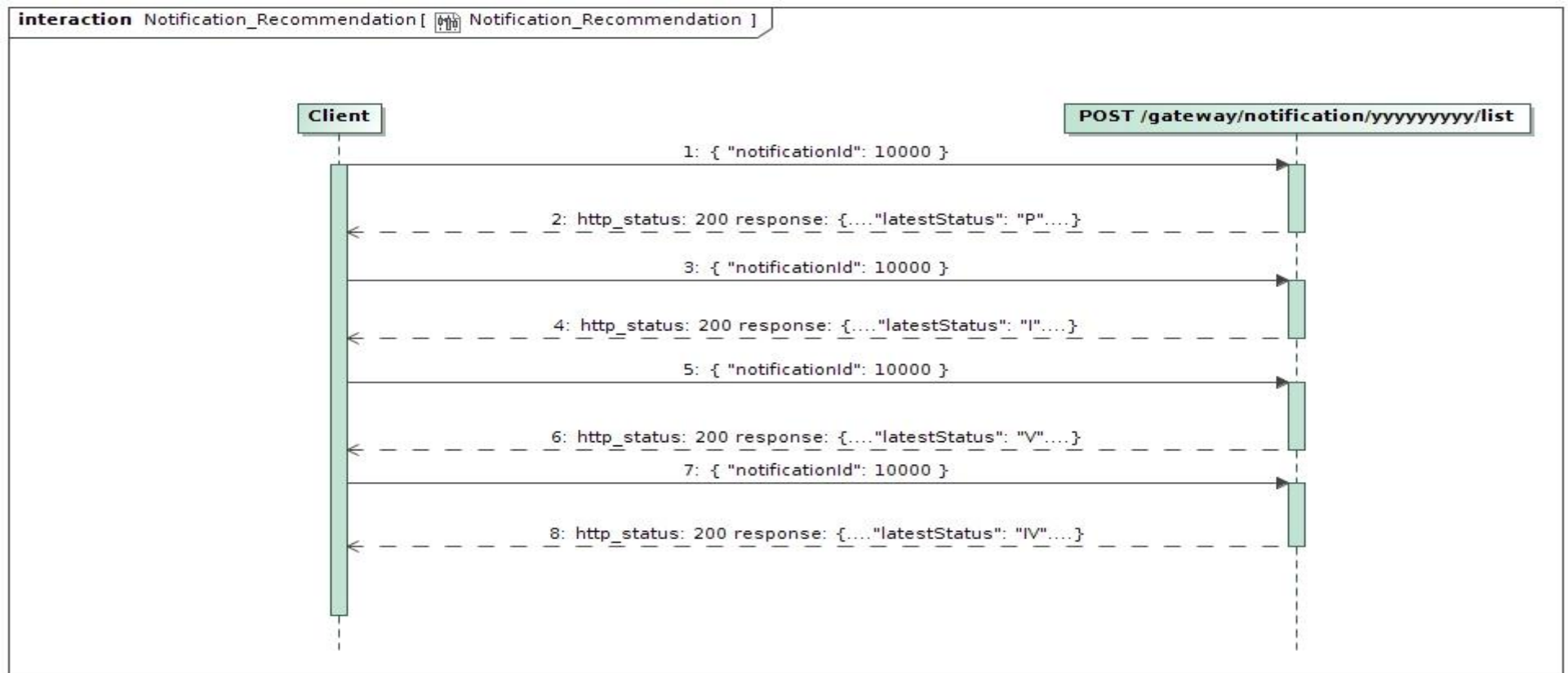

Possible status flow

- Happy status flow is: P → I → V → IV
- Notification with cancellation: P → A

- Notification with error status flow: P → I → V → K
- Notification with error which was later fixed (this is not a common case): P → I → V → K → IV

where statuses

- P - notification registered
- A - notification cancelled
- I - notification transfered to source system
- V - notification is in progress
- K - error appear during notification processing
- IV - notification was successfully processed

6.4.3 Cancel notification

It is possible to cancel notification during 1 hour after registration. After 1 hour notification is sent to the source system for processing and cancelation is not possible any more.

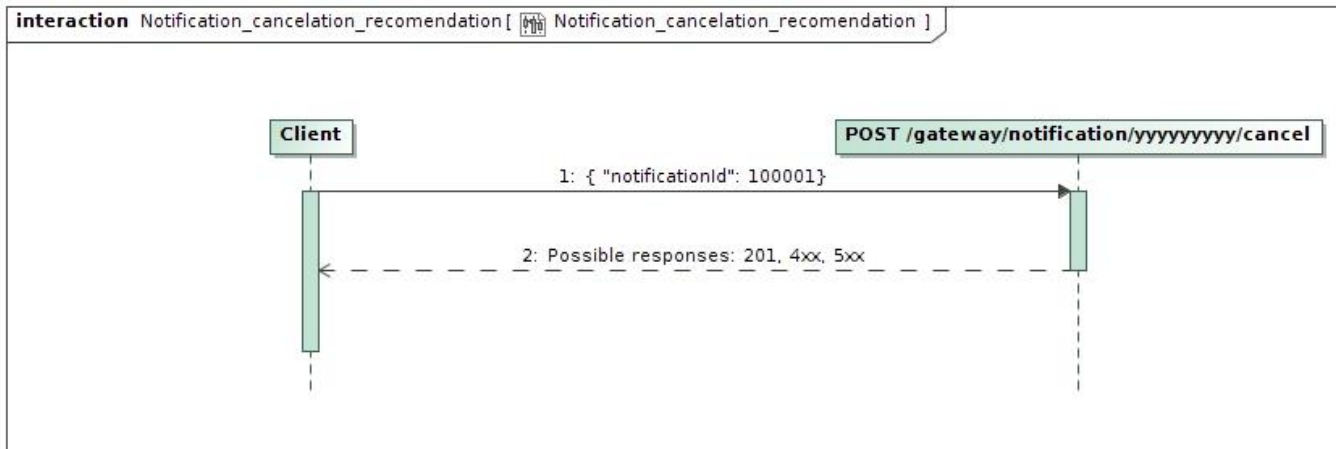

Change notification endpoint mapping

Change notification endpoint	Change notification list endpoint	Change notification cancel endpoint	object list
------------------------------	-----------------------------------	-------------------------------------	-------------

/gateway/notification/cancellation	/gateway/notification/cancellation/list	/gateway/notification/{notificationId}/cancellation/cancel	/gateway/object/my/active/list
/gateway/notification/contract	/gateway/notification/contract/list	/gateway/notification/{notificationId}/contract/cancel	/gateway/object/all/active/list
/gateway/notification/contract/object/supply-state	/gateway/notification/contract/object/supply-state/list	/gateway/notification/{notificationId}/contract/object/supply-state/cancel	/gateway/object/my/active/list
/gateway/notification/contract/tariff-plan	/gateway/notification/contract/tariff-plan/list	/gateway/notification/{notificationId}/contract/tariff-plan/cancel	/gateway/object/my/active/list
/gateway/notification/contract/termination	/gateway/notification/contract/termination/list	/gateway/notification/{notificationId}/contract/termination/cancel	/gateway/object/my/active/list

6.5 Meter reading declaration

There are two main activities in meter reading declaration module.

1. Get the latest reading data.
2. Post new reading data.

6.5.1 Get the latest reading data

It's possible to get reading data in two approaches.

1. Get all reading data or by objects
2. Get reading data by changes

In both approaches you should use same endpoint **POST /gateway/declaration/reading/list** but with different request body.

Also it's possible to use **GET /gateway/supplier/v3/get-declaration-data** for getting reading data by objects. But in the future it might be deprecated and removed so we are not recommending to use it.

6.5.1.1 Get all reading data or by objects

It's the simplest way to get reading data by using endpoint **POST /gateway/declaration/reading/list** with empty request body (if you want reading data of all objects) or by using objectNumber in request body (if you want reading data of concrete object).

If data do not fit into one response body, you should use pagination as described in SYNC.

6.5.1.2 Get reading data by changes

It's possible to use same endpoint **POST /gateway/declaration/reading/list** if you want to get object data which has data changes. For example object has new declared readings or object has new meters and etc.

To get these changes cdcDateTimeFrom and cdcDateTimeTo should be used as shown in sequence diagram below.

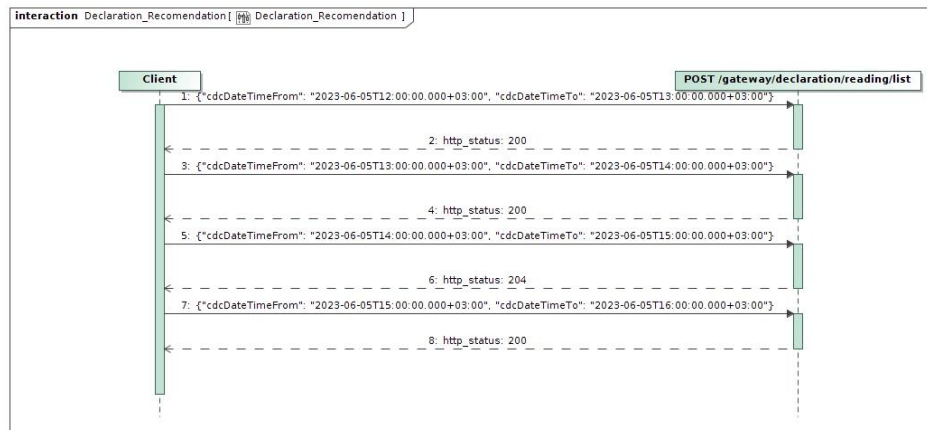

If response is not empty then HTTP status 200 will be returned.

If response is empty then HTTP status 204 will be returned.

Every call will give you response with data in format:

```
[
  {
    "objectNumber": "33041000",
    "cdcDateTime": "2023-06-05T14:45:07.540324+03:00",
    "meters": [
      {
```

```

    "conversionPoss": false,
    "meterNumber": "45150",
    "meterScaleLength": 14,
    "meterAutomated": true,
    "readings": null
  },
  {
    "conversionPoss": false,
    "meterNumber": "71000",
    "meterScaleLength": 14,
    "meterAutomated": true,
    "readings": null
  }
]
},
{
  "objectNumber": "73010000",
  "cdcDateTime": "2023-06-05T15:00:10.803866+03:00",
  "meters": [
    {
      "conversionPoss": false,
      "meterNumber": "620000",
      "meterScaleLength": 7,
      "meterAutomated": false,
      "readings": [
        {
          "scaleId": 3199000,
          "scaleIdentifier": "VT",
          "scaleProduct": "VK",
          "readingFromDate": "2023-02-20T00:00:00",
          "readingMin": 7545,
          "readingFrom": 8145,
          "readingSource": "D"
        }
      ]
    }
  ]
}
]
}
]

```

You will get changes in these cases:

- New readings was declared

- New meter was added or old meter was removed
- Meter was parameterized and one of parameters: meterScaleLenght, scaleIdentifier, scaleProduct was changed
- New independent supplier ownership get started
- Meter was changed from manual to automated. In this case readings will be not provided and will have value null.

Note that:

- If response gives more than 10 000 objects, you will need to use pagination as described in [Sync](#)
- Time between cdcDateTimeTo and current_timestamp should be equal or more than 2 hours. It's because DH sometimes get data changes with some latency.
- There are no restriction with cdcDateTimeFrom and cdcDateTimeTo interval lengths. Given example in sequence diagram shows request with 1 hour intervals. But also it could be 15 min, 4 hours or 1 day intervals.
- For initial load request with empty body could be used.

6.5.2 Post new reading data

In order to declare new readings you should use endpoint: **POST /gateway/supplier/send-declaration-data**

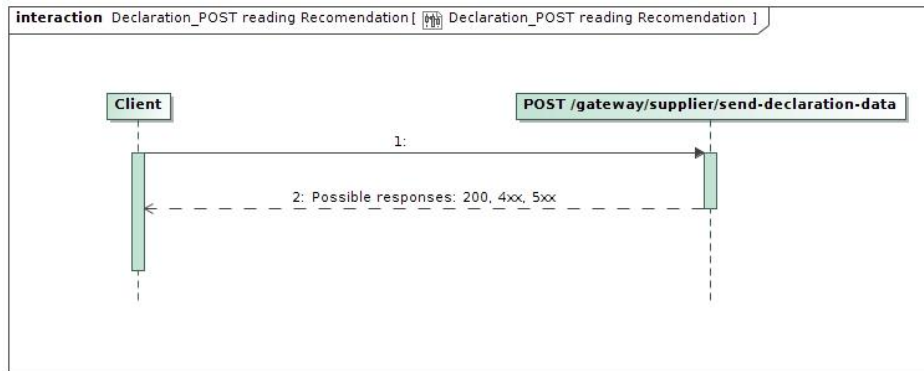

Request example

request body structure

```

[
  {
    "dataWriteDate": "2023-06-05T14:33:50.730Z",
    "objectNumber": "73010000",
    "readings": [
      {

```

```
"reading": [  
  {  
    "conversion": false,  
    "readingTo": 8170,  
    "skIId": 3199000  
  }  
]  
]  
]
```

Few notes:

- You can declare multiple objects with one request. But max 1000 objects
- You should declare concrete object all meters and all scales at ones otherwise error will be returned.
- After declaration it will take some time to get readings visible in **POST /gateway/declaration/reading/list**. It takes some time to sync data between internal systems.

6.6 Access Rights

Access right module is responsible for storing granted accesses to private data for involved party (third party, independent supplier). Involved party which got consent from private person what he is able to access private data, should register consent in the access right module.

Activities which could be done in access right module

- Register access right
- List all access rights
- Cancel access right

6.6.1 Register access right

Registering access rights for objects.

interaction Register_All_Access_Right_Recommendation [ Register_All_Access_Right_Recommendation]

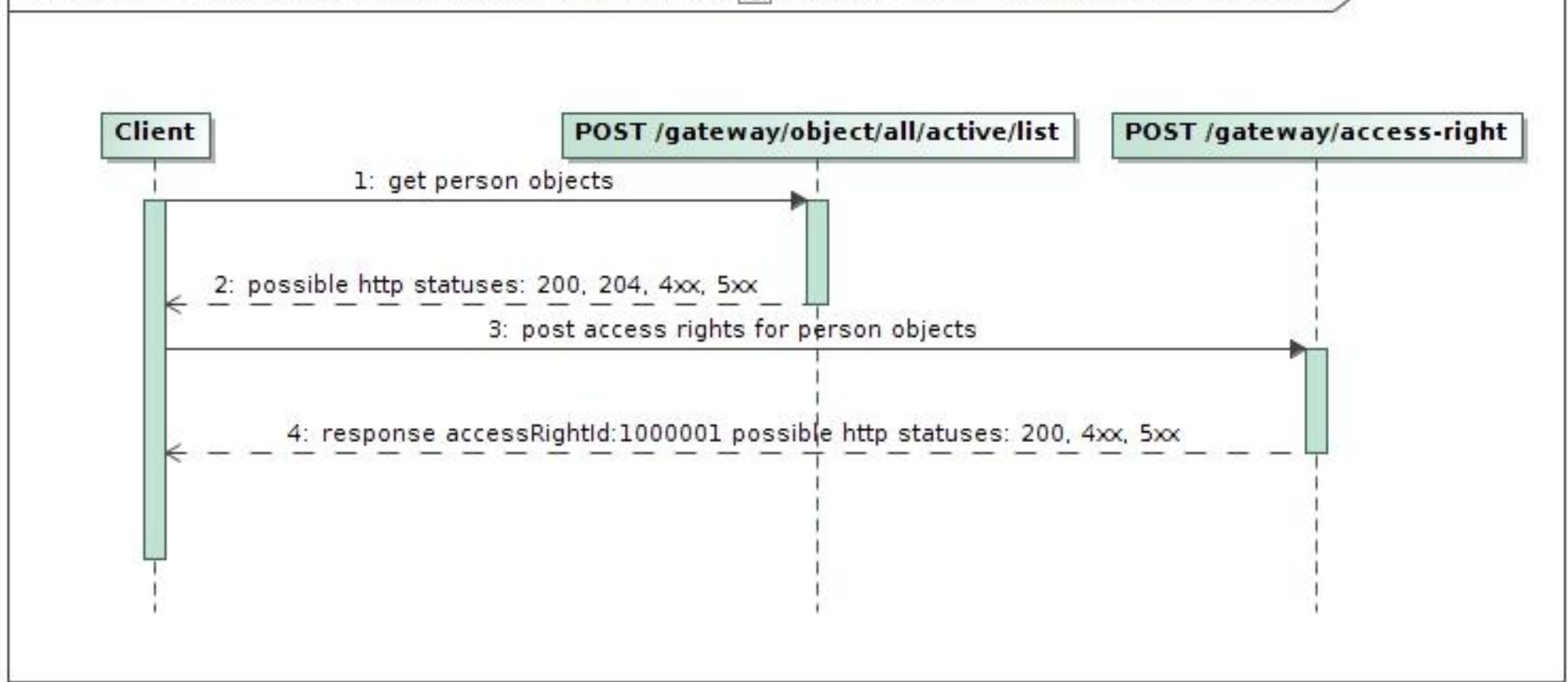

Notes:

- Access right is ordered at the person/company scope. With one request you can order access rights for multiple objects, but these objects must belong to same person/company.
- Posting access rights some object information is needed. Object information can be obtained from **gateway/object/all/active/list** endpoints.
- Everybody can get data from **gateway/object/all/active/list**, but before accessing data from here, object owner's consent should be gotten.
- Access right for private person data can be ordered for max 1 year period only.
- Before registering access right, you should get consent for access right from the object owner.
- Access right to involved party can be given directly from object owner via ESO-S system. Such access right record will have source ESOS.
- If object's owner was changed then previous access rights becomes deleted automatically.
- In access right module, object information stays the same as was at access right registration time.
- Http 200 status when register was successful.

- Http 4xx status when some business rule was violated.
- Http 5xx status when unexpected service side error occurred

6.6.2 List all access rights



Response structure

```

{
  "accessRightId": 0,
  "accessRightSource": "ESOS",
  "accessRightValidFrom": "2022-01-01",
  "accessRightValidTo": "2022-01-01",
  "consumerCode": "string",
}
  
```

```

"contractModel": "BSS",
"contractType": "SBTS",
"generatingObjectType": "G",
"objectAddressSearch": "string",
"objectNumber": "string",
"personCode": "string",
"powerPlantType": "A",
"supplierType": "VT",
"userNameSearch": "string"
}

```

Notes:

- Access right source can be: ESOS (when access right was registered via ESO-S system), DH (when access right was registered via DH system)
- Access right valid date from is a time when records was registered. With date time precision.
- Object can have only one active access right record. If we try to register access right for object which already has record, then active record will be updated.
- Access right object data is stored according to the newest owner. So, data search by old owner will give empty response.
- Http 200 status when response was successfully generated.
- Http 204 status when response was successfully generated, but content is empty.
- Http 4xx status when some business rule was violated.
- Http 5xx status when unexpected service side error occurred.

6.6.3 Cancel access right

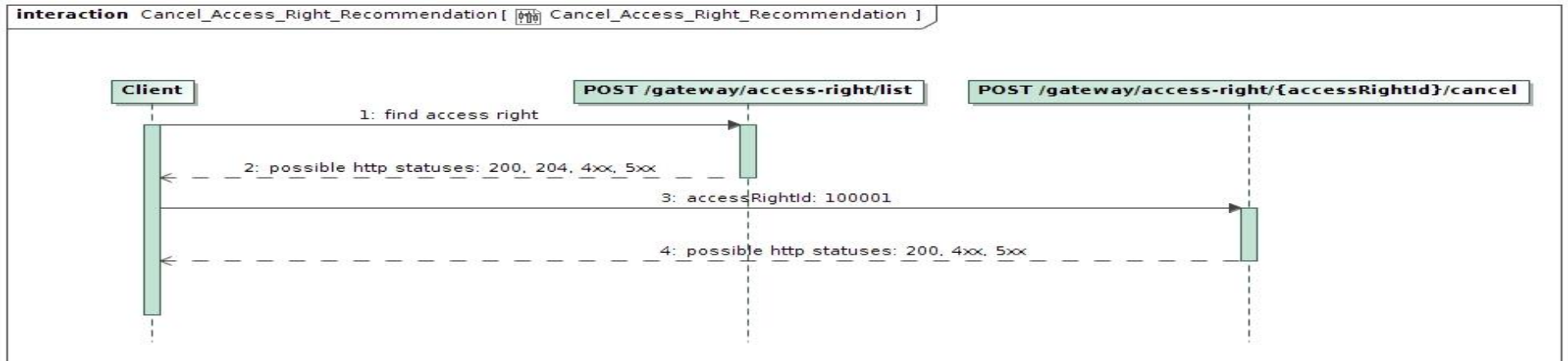

Notes:

- Before cancelling access right you should find it's access right ID.
- Cancel operation can be done for one access right with one request.
- Cancel operation can be done for access right despite source (DATAHUB or ESOS).
- Http 200 status when register was successful.
- Http 4xx status when some business rule was violated.
- Http 5xx status when unexpected service side error occurred.

6.6.4 Access right integration with data order module

After access right registration involved party gets possibility to access private data. Private data can be access in data order module which is described in ASYNC.

Order types with suffix "-acr" requires access rights. Currently:

- data-hr-15min-mtr-lvl-acr
- data-hr-15min-obj-lvl-acr
- data-sum-obj-lvl-acr
- report-obj-acr

7. DataHub Gateway API documentation

7.1 Declaration controller

Declaration controller provides information about API methods intended for objects non smart meters data declaration amount for DSO.

It is recommended to use these methods in Supplier's user interface system or other internal system which collect or allows to provide meter related data. GET and POST methods can be used suppliers Self-Service portals to let suppliers customers declare for them self.

i Declaration data transfer Supplier ↔ DH ↔ DSO: Supplier provided data to DH Database as soon as possible are transfered to DSO Billing system (it is planning that can be up to 1 hour transaction delay). Every 30min data are synced from DSO Billing system to DH DataBase to provide information to Supplier (it is planning that data in DH Database can be 0-60min. age comparing with DSO Billing database.)

7.1.1 GET /gateway/supplier/v3/get-declaration-data

URL	GET /gateway/supplier/v3/get-declaration-data?first={integer}&count={integer}&customerId={string}&objectNumber={string}
Description	The supplier receives data on the latest known meter scale consumption of its customers objects.

Parameters	URL parameters: <ul style="list-style-type: none"> • first - index (starting from 0) of the object that must be presented first in the return list. Optional. The default value is 0. • count - number of objects in the return list. Optional. The default value is 30. • customerId - user code of the contracted customer for data filtering • objectNumber - customer object number for data filtering 		
Request Body	GET request does not have BODY data model structure.		
Response	HTTP status code	Reason	Response description
	200	OK	Request completed successfully
	204	No Content	No data found according to the given parameters.
	400	Bad Request	Request error. The HTTP response body provides a list of errors in JSON format.
	401	Unauthorized	An attempt was made to connect to a non-public method that requires authentication, but no user credentials were provided.
	403	Forbidden	According to the access control policy, the current user does not have access to perform the requested action.
	404	Not Found	Either there is no API method associated with the request URL path that did not return the data.
Rules	No.	Rule description	Attributes
	1.	Customers and their objects belonging to the supplier are selected according to the supplier ID encrypted in the supplier identification key.	Authentication Key
	2.	URL parameters are optional. First, count parameters describe a sample of data to return in a single request. By default, the first 30 data of the client object are returned (first: 0, count: 30). If the supplier specifies first, count parameters otherwise, then the data is returned according to the request sent by the supplier, but not more than 50 000;	URL: first, count, customerId, objectNumber

	<p>i the maximum value per query can be 50 000 objects (max count>=50 000). If the supplier specifies more than 50 000, an error message 12 is displayed.</p> <p>If the vendor does not specify customerId, objectNumber URL parameters, all vendor object scale data (depending on first, count parameters) must be returned to the vendor. If the supplier specifies both parameters, then it is checked whether the specified object number belongs to the specified customer and the scales of a specific object are derived. If an error occurs, error message code 2 is returned.</p> <p>first - index (starting from 0) of the object that must be presented first in the return list. Optional. The default value is 0;</p> <p>count - number of objects in the return list. Optional. The default value is 30;</p> <p>customerId - selection of object scale data according to customer number; By default, the first 30 objects of that client are output;</p> <p>objectNumber - selection of object scale data according to the object number; By default, only the scale data of a specific object is output (First, count parameters lose their effect);</p>	
3.	The method returns only the scales of non-automated meters.	-
4.	The method returns only the valid scales of valid meters.	-
5.	The method returns the latest confirmed (in DSO Billing system) actual readingFrom value, if there are not actual - then average readingFrom value.	readingFrom
6.	The readingMin value is selected from the DSO Billing system and specifies the lowest possible declaration readingTo value.	readingMin, readingTo
7.	The scaleMaxChar value is selected from the DSO Billing system and specifies maximum number of chars which could be provided to readingTo scale field.	readingTo, scaleMaxChar
8.	<p>The method returns the readingSource of the latest confirmed (in DSO Billing system) readingFrom value.</p> <p>The readingSource can be:</p>	readingSource

	A - automatically scanned readings D - your declared readings L - checked readings P - rewritten readings from a previous agreement V - average readings K - readings from credit document	
--	---	--

7.1.1.1 JSON BODY Request structure

The table below describes the JSON structure and elements of the get-declaration-data request BODY:

JSON Request structure			
-			
Attribute	type	obligation	description
-	-	-	-

7.1.1.2 JSON URL Request structure

The table below describes URL request attributes:

JSON Request structure			
-			
Attribute	type	obligation	description
first	integer	not required	Index (starting from 0) of the object that must be presented first in the return list.
count	integer	not required	Number of objects in the return list.
customerId	string(32)	not required	Filtering data by supplier-owned user code of the contracted customer.
objectNumber	string(20)	not required	Filtering data by supplier-owned customer object number.

7.1.1.3 JSON Response structure

If the get-declaration-data request is successful, method will return JSON data model which is described below.

JSON Response structure

```
[
{
  "clientId": "string",
  "customerId": "string",
  "clientName": "string",
  "readings":[
  {
    "objectNumber": "string",
    "objectAddress": "string",
    "counterNumber": "string",
    "scaleMaxchar": "number",
    "conversionPoss": "string",
    "scales": [
    {
      "scaleId": "number",
      "scaleIdentifier": "string",
      "scaleType": "string",
      "readingFromDate": "dateTime",
      "readingFrom": "number",
      "readingMin": "number",
      "readingSource": "string",
      "lastCheckedReadingValue": "string",
      "lastCheckedReadingValueDate": "dateTime"
    }
  ]
}
]
]
```

Attribute	type	obligation	description
clientId	string(20)	required	Client personal code if client is a resident (private customer) company code if client is a company (legal client)
customerId	string(32)	required	User code of the contracted customer
clientName	string(200)	required	Client name: Name Surname - if household customer

			Company name - if a legal entity
readings[]			List of the declaration readings data
readings[].objectNumber	string(20)	required	objectNumber of the object for the supply of electricity in which the contract is concluded.
readings[].objectAddress	string(4000)	required	object address
readings[].counterNumber	string(20)	required	Meter number which was provided by the manufacturer
readings[].scaleMaxchar	number(3)	required	Field specifies maximum number of chars which could be provided i readingTo field.
readings[].conversionPoss	boolean	required	Scale possible conversion. Possible values: true - possible conversion false - impossible conversion
readings[].scales[]			List of the scales
readings[].scales[].scaleId	number(8)	required	Scale ID which has to be provided when using POST method.
readings[].scales[].scaleIdentifier	string(50)	required	Internal scale identifier. Possible values: VT DD DN +QsumTS +WsumT1 +WsumT2 +WsumT3 +WsumT4 -QsumTS -WsumTS
readings[].scales[].scaleType	string(2)	required	Internal scale product type. Possible values (VALUE - explanation): D1 – day electricity D2 – evening electricity DD – electricity at day tariff

			MA- maximum loads MI – minimum loads N1 – night electricity N2 – morning electricity NK – electricity at night, Saturday, Sunday tariff RG- reactive electricity generated RV – reactive electricity consumption SV – Saturdays, Sundays and holidays electricity VD – average loads VK - one time zone
readings[].scales[].readingFromDate	dateTime	required	Date indicating when the last declared reading was registered and confirmed in the ESO Biling system. Last known readingsFrom date. Field format: YYYY-MM-DDThh:mm:ss
readings[].scales[].readingFrom	number(18)	required	Last declared reading value
readings[].scales[].readingMin	number(18)	not required	The minimum reading that can be provided by the Supplier or the customer in the Supplier Self-Service to the readingTo field in the POST method.
readings[].scales[].readingSource	string(1)	required	The reading source of the last declared reading value. Possible values (VALUE - explanation): A - automatically scanned readings D - your declared readings L - checked readings P - rewritten readings from a previous agreement V - average readings K - readings from credit document
readings[].scales[].lastCheckedReadingValue	number(18)	required	The value of the last reading written by the ESO.
readings[].scales[].lastCheckedReadingValueDate	dateTime	required	Date indicating when the value of the last reading written by ESO was registered and confirmed in the ESO Biling system. Field format: YYYY-MM-DDThh:mm:ss

7.1.1.4 Response Error codes

Below are the error codes and messages. Response codes and response content in case of error:

Code	Message	Explanation
2	"Object <objectNumber> not found or not belongs to You. Please check provided information."	A match between the supplier and the object number could not be found in the DataHub database.
12	"The maximum number of objects in one request is 50 000."	Supplier provide count attribute value which is more than 50 000. One request can return maximum 50 000 objects' information.

JSON Response example in case of error

```
{
  "errorMessages": [
    {
      "code": 0,
      "text": "string"
    }
  ]
}
```

7.1.2 POST /gateway/declaration/v2/reading/list

URL	POST /gateway/declaration/v2/reading/list?first={integer}&count={integer}&sortKey={string}&sortOrder={ASC/DSC}
Description	The method is intended to obtain the last declared data of the supplier's customer objects. The method is also designed to obtain changes in the declaration data.
Parameter	<p>URL parameter:</p> <ul style="list-style-type: none"> • first - index (starting from 0) of the object that must be presented first in the return list. Optional. The default value is 0. • count - number of objects in the return list. Optional. The default value is 10 000. • sort - sort the returned records by data. Optional. The default value is `objectNumber`. It can change and sort by `cdcDateTime`. If sort is not provided, the default value applies. • sortOrder - sort by ascending or descending order: ASD / DSC. Optional. The default value is `ASC`. If sortOrder is not provided, the default value applies.
Header	After decrypting the supplier authentication key, the supplier ID is used to select the data, X-SupplierId.
Request	{

	<pre>"objectNumber": "string", "cdcDateTimeFrom": "datetime + timezone", "cdcDateTimeTo": "datetime + timezone" }</pre>		
Response HTTP code	HTTP status code	Reason	Description
	200	Ok	Request completed successfully.
	204	No content	No data found according to the given parameters.
	400	Bad request	Request error. The HTTP response body provides a list of errors in JSON format. (<i>Error response of the JSON structure below</i>).
	401	Unauthorized	An attempt was made to connect to a non-public method that requires authentication, but no user credentials were provided.
	403	Forbidden	According to the access control policy, the current user does not have access to perform the requested action.
	404	Not Found	Either there is no API method associated with the request URL path, or the request contains one or more parameters that did not return the data.
Response	<pre>[{ "objectNumber": "string", "cdcDateTime": "datetime with timezone", "meters": [{ "conversionPoss": true, "meterNumber": "string", "meterScaleLength": number, "meterAutoamted": boolean, "readings": [{ "scaleId": number, "scaleIdentifier": "string", "scaleProduct": "string", "readingFromDate": "datetime",</pre>		

	<pre> "readingMin": number, "readingFrom": number, "readingSource": "string" "lastCheckedReadingValue": "string", "lastCheckedReadingValueDate": "dateTime" }] }] }] </pre>				
Error response	<pre> { "errorMessages": [{ "code": 0, "text": "string" }] } </pre>				
Rule	No.	Rule description	Error code	Error	Attributes
	1.	Customers and their objects belonging to the supplier are returned according to the supplier ID (X-SupplierId) encrypted in the supplier identification key.	-	-	X-SupplierId, supplier identification key
	2.	The method returns all objects that have signed contracts.	-	-	-
	3.	<p>The method returns only the scales of non-automated meters.</p> <p>All automatic and non-automatic meters are displayed.</p> <p>If an automatic meter is selected, the values "meterAutoamted": true and "readings": null are returned</p> <p>If a non-automatic meter is selected, the values "meterAutoamted": false and "readings": a full object with scales and readings are returned.</p>	-	-	-

	4.	Only valid scales are returned where the current time falls between meter_scale_validity.valid_from and meter_scale_validity.valid_to.			scaleId
	5.	Only valid scale types (product types) are returned.	-	-	scaleProduct
	6.	The maximum value per query can be 10 000 objects (max count<=10 000). If the supplier specifies more than 10 000, an error message 12 is displayed.	12	The maximum number of objects in one request is 10 000.	-

7.1.2.1 JSON Request structure

The table below describes the structure of the JSON response:

No.	Attribute	Type	Obligation	Description
1.	objectNumber	string(20)	not required	Object number.
2.	cdcDateTimeFrom	dateTime + timezone	not required	Change date from of the object (inclusive).
3.	cdcDateTimeTo	dateTime + timezone	not required	Change date to of the object (inclusive).

7.1.2.2 JSON Response structure

The table below describes the structure of the JSON response:

No.	Attribute	Type	Obligation	Description
1.	objectNumber	String(20)	required	Object number.
2.	cdcDateTime	datetime with timezone	required	The last modified date of the object.
3.	meters[]			
3.1	meterNumber	String(20)	required	Meter number.

No.	Attribute	Type	Obligation	Description
3.2	meterScaleLength	Integer	required	Field specifies maximum number of chars which could be provided readingTo field.
3.3	conversionPoss	boolean	required	Scale possible conversion. Possible values: <ul style="list-style-type: none"> • true - possible conversion • false - impossible conversion
3.4	meterAutomated	boolean	required	Automated meter feature.
4.	readings[]			
4.1	scaleId	number(8)	required	Scale ID.
4.2	scaleIdentifier	string(10)	required	Internal scale identifier. Possible values: <ul style="list-style-type: none"> - VT - DD - DN - +QsumTS - +WsumT1 - +WsumT2 - +WsumT3 - +WsumT4 - -QsumTS - -WsumTS
4.3	scaleProduct	string(2)	required	Internal scale product. Possible values (VALUE - explanation): <ul style="list-style-type: none"> - D1 – day electricity - D2 – evening electricity - DD“ – electricity at day tariff - MA- maximum loads - MI – minimum loads - N1 – night electricity - N2 – morning electricity - NK – electricity at night, Saturday, Sunday tariff - RG- reactive electricity generated - RV – reactive electricity consumption

No.	Attribute	Type	Obligation	Description
				<ul style="list-style-type: none"> - SV – Saturdays, Sundays and holidays electricity - VD – average loads - VK - one time zone
4.4	readingFromDate	dateTime	required	Date indicating when the last declared reading was registered and confirmed in the ESO Billing system. Last known readingsFrom date. Field format: YYYY-MM-DDThh:mm:ss
4.5	readingFrom	number	required	Last declared reading value.
4.6	readingMin	number	not required	The minimum reading that can be provided by the Supplier or the customer in the Supplier Self-Service to the readingTo field in the POST method.
4.7	readingSource	string(2)	required	The reading source of the last declared reading value. Possible values (VALUE - explanation): <ul style="list-style-type: none"> - A - automatically scanned readings - D - your declared readings - L - checked readings - P - rewritten readings from a previous agreement - V - average readings
4.8	lastCheckedReadingValue	number(18)	required	The value of the last reading written by the ESO.
4.9	lastCheckedReadingValueDate	dateTime	required	Date indicating when the value of the last reading written by ESO was registered and confirmed in the ESO Billing system. Field format: YYYY-MM-DDThh:mm:ss

7.1.2.3 Error Response structure

The following table describes the JSON structure in the event of a response error:

No.	Attribute	Type	Obligation	Description
1.	code	number	required	Error code.

No.	Attribute	Type	Obligation	Description
2.	text	string(4000)	required	Error message.

7.1.2.4 Algorithm for using DELTA solution



No.	Instructions for use	Stage	The value of the time variable	Request body
	<pre> sequenceDiagram participant NT as NT system participant DataHub as DataHub /gateway/declaration /reading/list Note over NT: T1 NT->>DataHub: call for initial load activate DataHub DataHub-->>NT: return deactivate DataHub Note over NT: T2 NT->>DataHub: periodic call for delta activate DataHub DataHub-->>NT: return deactivate DataHub Note over NT: T3 NT->>DataHub: periodic call for delta activate DataHub DataHub-->>NT: return deactivate DataHub Note over NT: T4 NT->>DataHub: periodic call for delta activate DataHub DataHub-->>NT: return deactivate DataHub </pre>			
1.	When starting a solution with the DELTA decision for the first time, an initial load must be performed first. The start time of the initial charge is saved.	Initial loading	TIME = T1	



No.	Instructions for use	Stage	The value of the time variable	Request body
2.	A request is sent to get the last declarations for all supplier objects. No parameters are specified in the query. The result is saved.	Initial loading		{}
3.	After the initial data load, regular data loads continue. The start time of the first regular charge is saved.	Regular loading	TIME = T2	
4.	A request is sent to receive a change in the declaration data of all the supplier's objects during the time period T2 - T1. In the query parameter cdcDateTimeFrom we specify the time T1. The result is saved.	Regular loading		{ "cdcDateTimeFrom":T1 }
5.	Periodically repeating steps from step 3.	Regular loading		

7.1.3 POST /gateway/supplier/send-declaration-data

URI	POST /gateway/supplier/send-declaration-data		
Description	The method is intended to provide readings of the scale declared by the object. The readings are given at the object level, so all counters on the full scale must be presented at the same time.		
Parameters	none		
Request Body	POST request structure provided in BODY		
Response	HTTP status code	Reason	Response description
	201	Created	Request completed successfully

	400	Bad Request	Request error. The HTTP response body provides a list of errors in JSON format.
	401	Unauthorized	An attempt was made to connect to a non-public method that requires authentication, but no user credentials were provided.
	403	Forbidden	According to the access control policy, the current user does not have access to perform the requested action.
	404	Not Found	Either there is no API method associated with the request URL path, or the request contains one or more parameters that did not return the data.
Rules	No.	Rule description	Attributes
	0.	If an attribute has defined possible values, the value index can be specified by specifying the value of the attribute in the request. Indices of all possible values start from 0.	All attributes with specified values.
	1.	<p>Customers and their objects belonging to the supplier are selected according to the supplier ID encrypted in the supplier authentication key. It is checked whether the object number belongs to the supplier. If the object does not belong to the same supplier, output an error 10.</p> <p>If the supplier wants to declare the data of the customer who no longer belongs to him, but belonged to the previous month, then the supplier can declare the data for the previous month on the first working day of the next month until 12:59:59 h.</p>	Authentication key, objectNumber
	2.	Checked if all required fields are filled. If on of the field left blank, error 1 is displayed.	All attributes
	3.	<p>The date of the declared reading must be the day of the current month, except for the first working day of the month (it must be calculated when the first working day of the month is taking into account public holidays, eg 2021.01). The declaration must be closed on the first working day of the month at 12:59:59. It also checks that the date and time of dataWriteDate is not a future time compared to the server sysdate.</p> <p>If error occur, error code 3 are displayed.</p> <p>Examples:</p>	dataWriteDate

	<p>Sysdate 2020-10-01 12:15, dataWriteDate 2020-08-30T16:55:00 Sysdate 2020-10-01 12:15, dataWriteDate 2020-09-01T00:55:00 Sysdate 2020-10-01 12:15, dataWriteDate 2020-10-01T08:00:00 Sysdate 2020-10-01 12:15, dataWriteDate 2020-10-01T08:00:00 Sysdate 2020-10-01 13:05, dataWriteDate 2020-10-01T09:00:00 Sysdate 2020-10-01 13:05, dataWriteDate 2020-09-25T15:55:00 Sysdate 2020-10-01 13:05, dataWriteDate 2020-10-25T08:00:00</p> <p>Lines (2-5) will be accepted, because comply requirement, other lines will be rejected, because period for August (1) and September (6) was closed and (7) because declaration in the future is not possible.</p> <p> Business process: For the reporting month, the declaration may be made no later than the first day of the post-reporting month 13:00:00, indicating that the readings provided is no later than the last day of the reporting month 23:59:59.</p>	
4.	<p>The maximum number of characters in the reading ReadingTo is checked. If the number of characters exceeds the specified number, output error message 4.</p> <p> The verification in the supplier's system shall be performed using the value of readings[].scaleMaxchar obtained in the parameters of the GET method.</p>	readingTo
5.	<p>The scale reading (readingTo) can only be integers (characters are not available). If the display is not an integer or the value has characters, error message no. 5.</p>	readingTo
6.	<p>The data types skllId and dataWriteDate are checked. If the types do not meet the required requirements, message no. 6.</p>	skllId, dataWriteDate
7.	<p>A reading smaller than the readingMin value cannot be declared if no scale conversion occurs. Check that readingTo is greater than or equal to the value of the declared scale readingMin and conversion = N. If scale conversion is possible, then this value may be less than readingMin.</p> <p>If an error occurs, message no. 5.</p>	readingTo, conversion
8.	<p>The conversion indicator may be provided if the "conversationPoss:T" is obtained for the said scale in the GET method and if the estimated consumption is less than half of the maximum consumption of the scale.</p> <p> How the maximum consumption of the scale is calculated. For example, GET method returns "scaleMaxchar:5", then the maximum scale consumption can be 99999.</p> <p>If an error is detected, an error message 7 is displayed.</p>	conversion, readingTo

9.	<p>Readings can only be declared for valid scales. Checking that the scalld of the specified scale is still valid. If the scale is no longer valid, an error message 8 is displayed.</p> <p> This error can usually occur if you make the declaration using data that is out of date.</p>	skllId
10.	If skllId could not be found in the database, an error message 8 is displayed.	skllId
11.	<p>The value of the objectNumber attribute checks whether the user is household or commercial. If the consumer is household, it is permissible to specify the value of readingsTo such that after the mathematical operation readingsTo - readingsFrom <= 20 000 (This parameter is configurable, the value of this parameter can change). (consumption <=20 000 kwh).</p> <p> If the customer is household and the consumption is greater than 20 000 kwh, please contact DSO.</p> <p>If an error occurs, message 9 is displayed.</p>	readingTo
12.	Checks if the specified objectNumber can be found in the DataHub database. If it cannot be found, an error message 2 is displayed.	objectNumber
13.	<p>It is mandatory to send the scales of all meters in the object at the same time. It is checked whether the supplier sends all the scales assigned to the specific object. The objectNumber selects all valid counters and scales valid in the counters (skllId) assigned to the object. The declaration takes place in the context of the object and only the ALL scales of ALL the meters in the object are submitted.</p> <p>If at least one scale is missing, an error message is displayed 10.</p>	skllId, objectNumber
14.	Supplier cannot declare the data for the object if the contractType = SBTS and belongs to the public supplier. An error message 14 is displayed.	objectNumber
15.	Supplier cannot declare the data for the object if the <i>db.object_meter meter_automated is false</i> . An error message 15 is displayed.	skllId, object_meter_ID, meter_automated

7.1.3.1 JSON Request structure

The table below describes the JSON structure and elements of the send-declaration-data request:

JSON Request structure
[{

```

"objectNumber": "string",
"dataWriteDate": "date",
"readings":[
{
  "reading": [
    {
      "sklId ": "number",
      "readingTo": "number",
      "conversion": "string"
    }
  ]
}
]
}
]

```

Attribute	type	obligation	description
objectNumber	string(20)	required	objectNumber of the object for the supply of electricity in which the contract is concluded.
dataWriteDate	dateTime	required	the date when the meter data was written off Date format: YYYY-MM-DDTHH:mm:ss
readings[]	list	required	List of the meters in the object
readings[].reading[]	list	required	List of the scales in the meter
readings[].reading[].sklId	number	required	scale ID number
readings[].reading[].readingTo	number(18)	required	Meter's scale written of value, which is provided by customer or supplier
readings[].reading[].conversion	boolean	required	The value of the scale conversion characteristic: true - Yes, there was a conversion false - no, no conversion (default value)

7.1.3.2 JSON Response structure

If the declaration request is successful, method will not return any data model, but HTTP 201 Created status.

JSON Response structure

If the request is successful, an **HTTP 201 Created** message is returned

Attribute	type	obligation	description
-	-	-	-

7.1.3.3 Response Error codes

Below are the error codes and messages. Response codes and response content in case of error:

Code	Message	Explanation
4	"All request parameters are required."	There is no provided one or more required attributes values.
2	"Object <objectNumber> not found or not belongs to You. Please check provided information."	A match between the supplier and the object number could not be found in the DataHub database.
3	"Declaration data for the previous reporting period can no longer be provided (period was closed) or Your provide date shows future time."	The supplier tries to provide readings for the previous reporting period or the future. Future declarations are not possible and declarations for the previous reporting period can no longer be provided.
4	"Incorrect number of digits in readingTo field. Please check maximum number of digits in this scale."	Too many digits on the scale.
5	"Parameter readingTo is integer and can not be less than value <i>readingMin</i> . Please check this field value."	Only integer values are possible and value has to be greater or equal to readingMin value.
6	"Incorrect data types."	There was provided incorrect data types in request.
7	"A conversion indicator may be provided if the estimated consumption is less than half of the maximum consumption of the scale and if the scale has a conversion indicator."	Scale reversal is possible only when the scale has an attribute that indicates the possibility of scale reversal.
8	"The scale skild does not exist or is no longer valid."	The scale is no longer valid or does not exist.
9	"Data belongs to household client and declared meter value is more than 20 000. Please check data and try again."	A household customer is trying to declare more than 20 000 kwh. The parameter is configurable, the value of the parameter may change.

Code	Message	Explanation
10	"The declaration process is performed in the context of the object. It has to be provided all meters with all scales which belongs to provided object. One of meter or scale is missing or meter automated, please check provided data."	The meter scales are incomplete in the declared data.
11	"objectNumber and customerId does not exist in DataHub Database."	We were unable to find a match between the object number and the customer code based on the information entered in the URL parameters.
12	"The maximum number of objects in one request is 50 000."	Supplier provide count attribute value which is more than 50 000. One request can return maximum 50 000 objects information.
13	"Meter scales with ids <sklid, sklid> are repeating."	Meter scales cannot be repeated for the same object.
14	Readings not accepted. The object [objectNumber] belongs to a public supplier.	Declare data cannot be declared if the object belongs to a public supplier.

JSON Response example in case of error

```
{
  "errorMessages": [
    {
      "code": 0,
      "text": "string"
    }
  ]
}
```

7.2 Access right controller

7.2.1 POST/gateway/access-right/v2/list

URL	POST /gateway/access-right/v2/list?first={integer}&count={integer}&sortKey={string}&sortOrder={ASC/DSC}
Description	The method to obtain information and a list of granted rights.
Parameters	<p>URL parameters:</p> <ul style="list-style-type: none"> first - index (starting from 0) of accessRightId that must be presented first in the return list. Optional. The default value is 0.

	<ul style="list-style-type: none"> • count - number of accesRightUuid in the return list. Optional. The default value is 30. • sort - optional. The default value is accessRightId • sortOrder - possible values ASD, DSC. Optional. The default value is ASD. <p>The data of the JSON form request are presented in the HTTP request body (BODY) (Query JSON structure, below).</p>		
Header	After decrypting the supplier authentication key, the supplier ID is used to select the data.		
JSON request	<pre>{ "accessRightId":"number" "personCode":"string", "consumerCode":"string", "objectNumber":"string", "objectAddressSearch":"string", "accessRightValidFrom":"datetime", "accessRightValidTo":"datetime", "accessRightSource":"string", "generatingObjectType":"string", "contractType":"string", "contractModel":"string", "supplierType":"string", "powerPlantType":"string", "userNameSearch":"string" }</pre>		
Response HTTP code	HTTP status code	Reason	Description
	200	OK	Request completed successfully
	204	No Content	No data found according to the given parameters.
	400	Bad Request	Request error. The HTTP response body provides a list of errors in JSON format.
	401	Unauthorized	An attempt was made to connect to a non-public method that requires authentication, but no user credentials were provided.
	403	Forbidden	According to the access control policy, the current user does not have access to perform the requested action.

	404	Not Found	Either there is no API method associated with the request URL path, or the request contains one or more parameters that did not return the data.
JSON response	<pre>[{ "accessRightId": "number", "accessRightValidFrom": "datetime", "accessRightValidTo": "datetime", "daysLeft": "number", "accessRightSource": "string", "userName": "string", "objectNumber": "string", "generatingObjectType": "string", "objectAddress": "string", "contractModel": "string", "supplierType": "string", "tariffPlan": "string", "timeZone": "string", "powerPlantObjects": [{ "powerPlantObjectNumber": "string", "powerPlantType": "string", "generatingPower": "double" }], "automationLevel": "string", "contractType": "string", "personName": "string", "personSurname": "string", "personCode": "string", "consumerCode": "string", "accessRightPhoneNo": "string", "accessRightEmailAddress": "string", "accessRightNote": "string" }]</pre>		

JSON error response	<pre> { "errorMessages": [{ "code": 0, "text": "string" }] } </pre>				
Rules	No.	Rule description	Error code	Error message	Attributes
	1.	The date from cannot be later than the date to. Equal can be.	1002	Date from cannot be later than date to.	accessRightValidFrom, accessRightValidTo
	2.	Only valid, irrevocable access rights granted must be included in the list.	-	-	-
	3.	The value of the count parameter must be less or equal to 10000.	1007	The value of the count parameter must be less or equal to 10000.	count

7.2.1.1 JSON request structure

The table below describes the structure of the JSON request:

No.	Attribute	type	obligation	description
1.	accessRightId	number	not required	Access right number (ID).
2.	personCode	string(20)	not required	Person code.

No.	Attribute	type	obligation	description
3.	consumerCode	string(20)	not required	Consumer code.
4.	objectNumber	string(20)	not required	Object number.
5.	objectAddressSearch	string(4000)	not required	Object address search.
6.	accessRightValidFrom	datetime	not required	Access right valid date From.
7.	accessRightValidTo	datetime	not required	Access right valid date To.
8.	accessRightSource	string(1)	not required	Access right source. Possible meanings: <ul style="list-style-type: none"> • ESOS – Per ESO-S; • DATAHUB – Per DATA HUB;
9.	generatingObjectType	string(1)	not required	Generating object type. Possible meanings: <ul style="list-style-type: none"> • G – GV (Gaminantis vartotojas); • N – NGV (Nutoles gaminantis vartotojas).
10.	contractType	string(10)	not required	Contract type. Possible meanings: <ul style="list-style-type: none"> • SBTS - Buitinė sutartis; • SKMS - Komercinė sutartis.
11.	contractModel	string(10)	not required	Contract model. Possible meanings: <ul style="list-style-type: none"> • BSS - Bendra sutartis ir sąskaita; • 2S2S - Dvi sutartys – dvi sąskaitos.
12.	supplierType	string(2)	not required	Supplier type. Possible meanings: <ul style="list-style-type: none"> • VT - visuomeninis tiekėjas; • GT - garantinis tiekėjas;

No.	Attribute	type	obligation	description
				<ul style="list-style-type: none"> NT - nepriklausomas tiekėjas.
13.	powerPlantType	string(1)	not required	Power plant type. Possible meanings: <ul style="list-style-type: none"> A – Atliekų; B – Biomasės; H – Hidroelektrinė; K – Kita; S – Saulės; T – TEC; V – Vėjo.
14.	userNameSearch	string(240)	not required	Username search.

7.2.1.2 JSON response structure

The table below describes the structure of the JSON response:

No.	Attribute	type	obligation	description
1.	accessRightId	number	required	Access right number (ID).
2.	accessRightValidFrom	datetime	required	Access right valid date From.
3.	accessRightValidTo	datetime	required	Access right valid date To.
4.	daysLeft	number	required	Number of days, how long the access right is still valid.
5.	accessRightSource	string(1)	required	Access right source. Possible meanings: <ul style="list-style-type: none"> ESOS – Per ESO-S; DATAHUB – Per DATA HUB;
6.	userName	string(240)	required	The user who added the granted right.

No.	Attribute	type	obligation	description
7.	objectNumber	string(20)	required	Object number.
8.	generatingObjectType	string(1)	not required	Generating object type. Possible meanings: <ul style="list-style-type: none"> • G – GV (Gaminantis vartotojas); • N – NGV (Nutoles gaminantis vartotojas).
9.	objectAddress	string(4000)	required	Object address.
10.	contractModel	String(10)	required	Contract model. Possible meanings: <ul style="list-style-type: none"> • BSS - Bendra sutartis ir sąskaita; • 2S2S - Dvi sutartys – dvi sąskaitos.
11.	supplierType	string(2)	required	Supplier type. Possible meanings: <ul style="list-style-type: none"> • VT - visuomeninis tiekėjas; • GT - garantinis tiekėjas; • NT - nepriklausomas tiekėjas.
12.	tariffPlan	String(200)	not required	Tariff plan of object.
13.	timeZone	String(2)	not required	Time zone of object. Possible meanings: <ul style="list-style-type: none"> • 1 - One; • 2 - Two; • VR - One with reactive; • 4 - Four (Smart); • DR - Differentiated with reactive; • N - Not established.
14.	powerPlantObjects: []			
14.1	powerPlantObjectNumber	string (20)	not required	Power plant object number.

No.	Attribute	type	obligation	description
14.2	powerPlantType	string (1)	not required	Power plant type. Possible meanings: <ul style="list-style-type: none"> • A – Atlieku; • B – Biomasés; • H – Hidroelektriné; • K – Kita; • S – Saulés; • T – TEC; • V – Vėjo.
14.3	generatingPower	double (10,3)	not required	The power generated by assigned power plant.
15.	automationLevel	string(1)	required	Automation level. Possible meanings: <ul style="list-style-type: none"> • FULL - Pilna; • PARTIAL - Daliné; • NONE - Néra.
16.	contractType	String(10)	required	Contract type. Possible meanings: <ul style="list-style-type: none"> • SBTS - Buitinė sutartis; • SKMS - Komercinė sutartis.
17.	personName	string(200)	required	Contract owner name / company name.
18.	personSurname	string(50)	not required	Contract owner surname.
19.	personCode	string(20)	required	Person code.
20.	consumerCode	string(20)	required	Consumer code
21.	accessRightPhoneNo	string(12)	not required	Access right phone number.

No.	Attribute	type	obligation	description
22.	accessRightEmailAddress	string(100)	not required	Access right phone email address.
23.	accessRightNote	string(4000)	not required	Notes.

7.2.1.3 Error response structure

The following table describes the JSON structure in the event of a response error:

No.	Attribute	type	obligation	description
1.	code	number	required	Error code.
2.	text	string(4000)	required	Error message.

7.2.2 POST /gateway/access-right

URL	POST /gateway/access-right
Description	<p>The supplier can grant rights by himself to access clients' historical data if has client agreement.</p> <p>Using this API method, the vendor grants itself the right to access the historical data of the client objects on behalf of the customer. Once the rights have been granted, the supplier can download the customer's historical data for a certain period of time and, on that basis, offer the customer a contract.</p>
Parameters	<p>URL parameters:</p> <p>The data of the JSON form request are presented in the HTTP request body (BODY) (Query JSON structure, below).</p>
Header	After decrypting the supplier authentication key, the supplier ID is used to select the data.

JSON request	<pre> { "consentSign": "boolean", "personName": "string", "personSurname": "string", "personCode": "string", "personBirthDate": "date", "accessRightInformation": [{ "objectNumber": "string", "accessRightValidTo": "date", "accessRightPhoneNo": "string", "accessRightEmailAddress": "string", "accessRightNote": "string" }] } </pre>		
Response HTTP code	HTTP status code	Reason	Description
	200	OK	Request completed successfully
	400	Bad Request	Request error. The HTTP response body provides a list of errors in JSON format.
	401	Unauthorized	An attempt was made to connect to a non-public method that requires authentication, but no user credentials were provided.
	403	Forbidden	According to the access control policy, the current user does not have access to perform the requested action.
404	Not Found	Either there is no API method associated with the request URL path, or the request contains one or more parameters that did not return the data.	
JSON response	[

	<pre>{ "accessRightId":"number" }</pre>				
JSON error response	<pre>{ "errorMessages": [{ "code": 0, "text": "string" }] }</pre>				
Rules	No.	Rule description	Error code	Error message	Attributes
	1.	The types of existing contracts for the objects must be the same.	3001	Access right assign is not possible. Different contract types of objects.	objectNumber
	2.	The attribute [objectNumber] is mandatory.	-	-	objectNumber
	3.	The meaning of the [objectNumber] cannot be repeated.	7	The object: [objectNumber (if there is more than one object, objects must be separated by the semicolon)] is repeating.	objectNumber
	4.	Must be specified valid object.	8	The object: [objectNumber (if there is more than one object, objects must be separated by the semicolon)] is not valid.	objectNumber
	5.	All objects specified in the request must belong to the owner specified in the request, the owner's contract must be valid and signed.	3007	The object: [objectNumber (if there is more than one object, objects must be separated by the semicolon)] does not belong to the specified owner / object does not have a valid contract.	personCode, personSurname, personName, personBirthDate, objectNumber
	6.	The attribute [personBirthDate] format must be: yyyy-mm-dd.	-	-	personBirthDate

		yyyy - year; mm - month; dd - day.			
	7.	The attribute [personName] is mandatory.	-	-	personName
	8.	The attributes [personSurname] and [personCode] or [personBirthDate] are mandatory if the object's existing contract type is SBTS.	3008	Person surname and personal code or date of birth are required if the contract type is SBTS.	personSurname, personCode, personBirthDate
	9.	The attribute [personCode] is required if the object's existing contract type is SKMS.	3009	The company code must be provided if the contract type is SKMS.	personCode
	10.	The attribute [accessRightValidTo] format must be: yyyy-mm-dd. yyyy - year; mm - month; dd - day.	-	-	accessRightValidTo
	11.	The attribute [accessRightValidTo] can not be equal to the past date.	3003	Access right expire date can not be equal to the past date.	accessRightValidTo
	12.	If the object of the existing contract type is SKMS, then the access right can be granted without restriction to the future.	-	-	accessRightValidTo
	13.	If the object of the existing contract type is SBTS, then the maximum access right can be granted for one year, calculated from the current inclusive.	3004	If the contract type is SBTS, the maximum access right can be granted for one year.	accessRightValidTo
	14.	The format of the attribute [accessRightPhoneNo] must be: +370XXXXXXXX, X - an integer (0 must be included).	3005	Phone no. incorrect format.	accessRightPhoneNo

	15.	The format of the attribute [accessRightEmailAddress] must be [text][@][text][.domain], letters in the text must be Latin. Can be at most 64 characters up to @ symbol and cannot begin/end with a dot or special character.	3006	Email address incorrect format.	accessRightEmailAddress
	16.	If a record has been created for the interested party (independent supplier) and the object and person, it is updated, otherwise a new access right is inserted.	-	-	objectNumber accessRightValidTo
	17.	The meaning of the [consentSign] must be: <ul style="list-style-type: none"> • True or • False. 	-	-	consentSign
	18.	If the attribute [consentSign] = False, then the creation must be disabled.	3010	It is necessary to confirm that the data provided is correct and the consent of the owner of the object has been obtained.	consentSign

7.2.2.1 JSON Request structure

The table below describes the structure of the JSON request:

No.	Attribute	type	obligation	description
1.	consentSign	boolean	required	Consent sign. I confirm that the consent of the specified person / company and / or legal basis to receive and process personal / company data has been obtained (person's name, surname / company name, person / company code, address, contact details, facility and electricity consumption data).
2.	personName	string(200)	required	Person name.

No.	Attribute	type	obligation	description
3.	personSurname	string(50)	not required	Person surname.
4.	personCode	string(20)	not required	Person code.
5	personBirthDate	date	not required	Person birth date.
accessRightInformation:[]				
6.	objectNumber	string(20)	required	Object number.
7.	accessRightValidTo	date	required	Access right valid date To.
8.	accessRightPhoneNo	string(12)	not required	Access right phone number.
9.	accessRightEmailAddress	string(100)	not required	Access right phone email address.
10.	accessRightNote	string(4000)	not required	Notes.

7.2.2.2 JSON Response structure

The table below describes the structure of the JSON response:

No.	Attribute	type	obligation	description
1.	accessRightId	number	required	Access right number (ID).

7.2.2.3 Error Response structure

The following table describes the JSON structure in the event of a response error:

No.	Attribute	type	obligation	description
1.	code	number	required	Error code.
2.	text	string(4000)	required	Error message.

7.2.3 POST /gateway/access-right/{accessRightId}/cancel

URL	POST /gateway/access-right/{accessRightId}/cancel		
Description	The supplier may remove the rights granted to him. He granted the rights himself with the client's permission, or the rights were granted to him by the client through ESO-S. The supplier can remove on rights which was granted by himself.		
Parameters	URL parameters: <ul style="list-style-type: none"> accessRightId - access right number (ID). Required 		
Header	After decrypting the supplier authentication key, the supplier ID is used to select the data.		
JSON request			
Response HTTP code	HTTP status code	Reason	Description
	200	OK	Request completed successfully
	204	No Content	No data found according to the given parameters.
	400	Bad Request	Request error. The HTTP response body provides a list of errors in JSON format.
	401	Unauthorized	An attempt was made to connect to a non-public method that requires authentication, but no user credentials were provided.
	403	Forbidden	According to the access control policy, the current user does not have access to perform the requested action.
	404	Not Found	Either there is no API method associated with the request URL path, or the request contains one or more parameters that did not return the data.

	423	Locked	<p>The source or destination resource of a method is locked.</p> <p>This response SHOULD contain an appropriate precondition or postcondition code, such as 'lock-token-submitted' or 'no-conflicting-lock'.</p>		
JSON response					
JSON error response	<pre>{ "errorMessages": [{ "code": 0, "text": "string" }] }</pre>				
Rules	No.	Rule description	Error code	Error message	Attributes
	1.	It must be checked that the access right according to the provided accessRightId exists, is valid at the moment and is not revoked.	3011	The access right was not found in the system / it is not valid / is revoked / the right does not belong to the user initiating the action.	accessRightId
	2.	Upon successful revocation, a revocation sign must be affixed.	-	-	-

7.2.3.1 Error Response structure

The following table describes the JSON structure in the event of a response error:

No.	Attribute	type	obligation	description
1.	code	number	required	Error code.
2.	text	string(4000)	required	Error message.

7.3 Order controller

7.3.1 POST/gateway/order/v2/list

URL	POST/gateway/order/v2/list
Description	Method will return list of the orders.
Parameters	<p>URL parameters:</p> <ul style="list-style-type: none">• first - the index of the report line, which must be the first in the return list (starting from 0). Optional. The default value is 0.• count - the number of order's rows in the return list. Optional. The default value is 30. If no count value is given, the default value count will be 30.• sort – ASC, DSC sorting.<ul style="list-style-type: none">○ By default, the reports' orders list must be sorted by the orderId;
Header	After decrypting the supplier authentication key, the supplier ID is used to select the data.
JSON request	<pre>{ "orderId": "integer", "orderTypes": ["string"], "submittedDateFrom": "datetime", "submittedDateTo": "datetime", "dateFrom": "date", "dateTo": "date", "latestStatuses": ["string"], "auto": "boolean", "userNameSearch": "string", "orderParametersSearch": "string" }</pre>

Response	HTTP status code	Reason	Response description
	200	OK	Request completed successfully.
	204	No content	No data found according to the given parameters.
	400	Bad Request	Request error. The HTTP response body provides a list of errors in JSON format.
	401	Unauthorized	An attempt was made to connect to a non-public method that requires authentication, but no user credentials were provided.
	403	Forbidden	According to the access control policy, the current user does not have access to perform the requested action.
	404	Not Found	Either there is no API method associated with the request URL path, or the request contains one or more parameters that did not return the data.
JSON Response	<pre>[{ "orderId": "integer", "orderType": "string", "submittedDate": "datetime", "dateFrom": "date", "dateTo": "date", "orderParameters": "string", "latestStatus": "string", "statusDate": "datetime", "expireDate": "datetime", "auto": "boolean", "userName": "string" }]</pre>		
JSON error response	<pre>{ "errorMessages": [{ "code": "integer", "text": "string" }] }</pre>		

					<pre> }] } </pre>
Rules	No.	Rule description	Error code	Error message	Attribute
	0.	If an attribute has defined possible values, the value index can be specified by specifying the value of the attribute in the request. Indices of all possible values start from 0.	-	-	All attributes with specified values.
	1.	The date from cannot be later than the date to. Equal can be.	1002	Date from cannot be later than date to.	dateFrom, dateTo, submittedDateFrom, submittedDateTo
	2.	Submitted date cannot be later than the current date but can be equal.	1010	Submitted date cannot be later than the current date.	submittedDateFrom, submittedDateTo
	3.	Date format is incorrect.	-	-	dateFrom dateTo submittedDateFrom submittedDateTo

7.3.1.1 JSON Request structure

The table below describes the structure of the JSON response:

Attribute	Type	Obligation	Description
orderId	Integer	Not required	The report ordering primary surrogate key.
orderTypes	String	Not required	The short name of the order type. Possible meanings: <ul style="list-style-type: none"> data-hr-15min-mtr-lvl - Automated quantities at the meter level; data-hr-15min-obj-lvl - Automated quantities at the object level; bill-2s2s-b2b - Billing report for 2S2S model B2B;

			<ul style="list-style-type: none"> • bill-bss-b2b - Billing report for BSS model B2B; • bill-bss-b2c - Billing report for BSS model B2C; • report-obj - Objects report; • data-hr-15min-history-changes – Net billing accounting scheme changes of interval data; • balance-data - Balance data report; • balance-by-generation-type – Balance by generation type report.
submittedDateFrom	Datetime	Not required	Order's submission date from.
submittedDateTo	Datetime	Not required	Order's submission date to.
dateFrom	Date	Not required	<p>The beginning of the reporting period:</p> <ul style="list-style-type: none"> • The format: YYYY-MM-DD; <p>The reporting period start date is the first day of the month.</p>
dateTo	Date	Not required	<p>The end of the reporting period:</p> <ul style="list-style-type: none"> • The format: YYYY-MM-DD; <p>The reporting period end date is the last day of the month.</p>
latestStatuses	["String(20)"]	Not required	<p>The status of the order. Possible meanings:</p> <ul style="list-style-type: none"> • IV – Completed; • V – In progress; • P – Submitted; • K – Error. <p>More then one type can be submitted.</p>
auto	Boolean	Not required	Indication that the order was ordered automatically.
userNameSearch	String(240)	Not required	The user who ordered the order.
orderParametersSearch	String	Not required	The order parameters.

7.3.1.2 JSON Response structure

The table below describes the structure of the JSON response:

Attribute	Type	Obligation	Description
orderId	Integer	required	The report ordering primary surrogate key.
orderType	String(100)	required	The short name of the order type. Possible meanings: <ul style="list-style-type: none"> • data-hr-15min-mtr-lvl - Automated quantities at the meter level; • data-hr-15min-obj-lvl - Automated quantities at the object level; • bill-2s2s-b2b - Billing report for 2S2S model B2B; • bill-bss-b2b - Billing report for BSS model B2B; • bill-bss-b2c - Billing report for BSS model B2C; • report-obj - Objects report; • data-hr-15min-history-changes – Net billing accounting scheme changes of interval data; • balance-data - Balance data report; • balance-by-generation-type – Balance by generation type report.
submittedDate	Datetime	required	The date of the order submission.
dateFrom	Date	required	The beginning of the reporting period: <ul style="list-style-type: none"> • The format: YYYY-MM-DD; • The reporting period start date is the first day of the month; • If the ordered report is Object Automated Consumptions, dateFrom can be not only the first day of the month.
dateTo	Date	required	The end of the reporting period: <ul style="list-style-type: none"> • The format: YYYY-MM-DD; • The reporting period end date is the last day of the month; • If the ordered report is Object Automated Consumptions, dateTo can be not only the last day of the month.
orderParameters	String(4000)	required	The search parameters by which the data in the ordered order was filtered.
latestStatus	String(20)	required	The current status of the order.
statusDate	Datetime	required	The latest status date.
expireDate	Datetime	required	Date of validity of the order. <ul style="list-style-type: none"> • The ordered report with status = Completed by default, is available only for 24 hours;

			<ul style="list-style-type: none"> The report, which was generated automatically by default, is available for 12 months.
auto	Boolean	required	Indication that the report order was ordered automatically.
userName	String(240)	required	The user who ordered the order.

7.3.1.3 Error Response Structure

The following table describes the JSON structure in the event of a response error:

No.	Attribute	type	obligation	description
1.	code	number	required	Error code.
2.	text	string(4000)	required	Error message.

7.3.2 POST/gateway/order/v2/data-hr-15min-mtr-lvl

URL	POST/gateway/order/v2/data-hr-15min-mtr-lvl		
Description	The method is intended for ordering data at the meter level of automated quantities.		
Parameters	URL: The JSON data is contained in the HTTP request (BODY) (<i>see JSON structure, below</i>).		
Header	After decrypting the supplier authentication key, the supplier ID is used to select the data.		
JSON request	<pre>{ "dateFrom": "date", "dateTo": "date", "consumptionCategories":[string, string], "objectNumbers":[string, string], "interval":"string" }</pre>		
Response HTTP code	HTTP status code	Reason	Description

	201	Created	The request has been successfully completed.		
	400	Bad Request	Request error. The HTTP response body provides a list of errors in JSON format. (<i>Error response of the JSON structure below</i>).		
	401	Unauthorized	An attempt was made to connect to a non-public method that requires authentication, but no user credentials were provided.		
	403	Forbidden	According to the access control policy, the current user does not have access to perform the requested action.		
	404	Not Found	Either there is no API method associated with the request URL path, or the request contains one or more parameters that did not return the data.		
JSON response	<pre>{ "orderId": "number" }</pre>				
JSON error response	<pre>{ "errorMessages": [{ "code": 0, "text": "string" }] }</pre>				
Rules	No.	Rule description	Error code	Error message	Attributes
	1.	If an attribute has defined possible values, the value index can be specified by specifying the value of the attribute in the request. Indices of all possible values start from 0.	-	-	All attributes with specified values.
	2.	Date format is incorrect.	-	-	dateFrom dateTo
	3.	The date from cannot be later than the date to. Equal can be.	1002	Date from cannot be later than date to.	dateFrom, dateTo

	4.	The date from and date to cannot be later than the current date but can be equal.	1008	Date from and date to cannot be later than the current date.	dateFrom
	5.	Object meter must be automated.	2007	The submitted object number: [objectNumber (if there is more than one object, objects must be separated by the semicolon)], was not found or the meter of object is not automated.	objectNumbers
	6.	Data cannot be older than 36 months old.	2012	Date from cannot be older than 36 months old.	dateFrom
	7.	Report can be ordered maximum for 12 months.	2013	The report can only be ordered for 12 months or less.	dateFrom dateTo
	8.	The period date from and date to must be less than date from configurable parameter.	2015	Data is not currently available for the selected reporting period.	dateFrom dateTo
	11.	A maximum of 500 objects can be submitted in a report order	2021	A maximum of 500 objects can be submitted in a report order	objectNumbers
	12.	If objectNumbers[null] , then the report can be ordered for a maximum of 1 month period.	2023	The report without specifying the objects can only be ordered for 1 month or less.	objectNumbers dateFrom dateTo

7.3.2.1 JSON Request structure

The table below describes the structure of the JSON request:

No.	Attribute	type	obligation	description
1.	dateFrom	Date	required	The beginning of the reporting period: <ul style="list-style-type: none"> The format: YYYY-MM-DD; The reporting period start date is the first day of the month.
2.	dateTo	Date	required	The end of the reporting period: <ul style="list-style-type: none"> The format: YYYY-MM-DD; The reporting period end date is the last day of the month.

3.	consumptionCategory	String(20)	required	The consumption category. Possible meanings: <ul style="list-style-type: none"> • P+; • P-; • Q+; • Q-;
4.	objectNumbers	String	required	Object number.
5.	interval	String	required	Consumption interval. Possible meanings: <ul style="list-style-type: none"> • HOUR • QUARTER

7.3.2.2 JSON Response structure

The table below describes the structure of the JSON response:

No.	Attribute	type	obligation	description
1.	orderId	Integer	required	The report ordering primary surrogate key.

7.3.2.3 Error Response Structure

The following table describes the JSON structure in the event of a response error:

No.	Attribute	type	obligation	description
1.	code	number	required	Error code.
2.	text	string(4000)	required	Error message.

7.3.3 POST/gateway/order/v2/data-hr-15min-obj-lvl

URL	POST/gateway/order/v2/data-hr-15min-obj-lvl
Description	The method is intended for ordering automated quantities at object level data.

Parameters	URL: The JSON data is contained in the HTTP request (BODY) (<i>see JSON structure, below</i>).		
Header	After decrypting the supplier authentication key, the supplier ID is used to select the data.		
JSON request	<pre>{ "dateFrom": "date", "dateTo": "date", "consumptionCategories": ["string", "string"], "objectNumbers": ["string", "string"], "interval": "string", "netBilling": { "intervalData": "boolean", "intervalDataRecalculation": "boolean", "intervalDataDetailed": "boolean" } }</pre>		
Response HTTP code	HTTP status code	Reason	Description
	201	Created	The request has been successfully completed.
	400	Bad Request	Request error. The HTTP response body provides a list of errors in JSON format. (<i>Error response of the JSON structure below</i>).
	401	Unauthorized	An attempt was made to connect to a non-public method that requires authentication, but no user credentials were provided.
	403	Forbidden	According to the access control policy, the current user does not have access to perform the requested action.

	404	Not Found	Either there is no API method associated with the request URL path, or the request contains one or more parameters that did not return the data.		
JSON response	<pre>{ "orderId": "number" }</pre>				
JSON error response	<pre>{ "errorMessages": [{ "code": 0, "text": "string" }] }</pre>				
Rules	No.	Rule description	Error code	Error message	Attributes
	1.	If an attribute has defined possible values, the value index can be specified by specifying the value of the attribute in the request. Indices of all possible values start from 0.	-	-	All attributes with specified values.
	2.	Date format is incorrect.	-	-	dateFrom dateTo
	3.	The date from cannot be later than the date to. Equal can be.	1002	Date from cannot be later than date to.	dateFrom, dateTo
	4.	The date from and date to cannot be later than the current date but can be equal.	1008	Date from and date to cannot be later than the current date.	dateFrom
	5.	Object meter must be automated.	2007	The submitted object number: [objectNumber (if there is more than one object, objects must be separated by the semicolon)] , was not found or the meter of object is not automated.	objectNumbers

6.	Data cannot be older than 36 months old.	2012	Date from cannot be older than 36 months old.	dateFrom
7.	Report can be ordered maximum for 12 months.	2013	The report can only be ordered for 12 months or less.	dateFrom dateTo
8.	The period date from and date to must be less than date from configurable parameter.	2015	Data is not currently available for the selected reporting period.	dateFrom dateTo
10.	A maximum of 500 objects can be submitted in a report order	2021	A maximum of 500 objects can be submitted in a report order	objectNumbers
11.	If objectNumbers [null] , then the report can be ordered for a maximum of 1 month period.	2023	The report without specifying the objects can only be ordered for 1 month or less.	objectNumbers dateFrom dateTo
12.	Parameters below can only be specified, if netBilling intervalData=TRUE : <ul style="list-style-type: none"> intervalDataRecalculation intervalDataDetailed <p>Note:</p> <p>Without specifying the latter parameters, i.e. specifying NULL will treat them as FALSE.</p>	2026	Recalculation of generation and consumption and an option to choose the type of power plant data view is only possible if the order is submitted for the object, which has "Net billing" accounting scheme.	netBilling,intervalData, intervalDataRecalculation, intervalDataDetailed
13.	If netBilling intervalDataRecalculation=TRUE , then recalculation can be initiated only for past periods.	2027	Recalculation of generation and consumption for object which has "Net billing" accounting scheme can be only initiated for past periods.	netBilling, intervalDataRecalculation, dateFrom, dateTo
14.	The meaning of the [ObjectNumber] notification cannot be repeated.	2028	The object: [objectNumber (if there is more than one object, objects must be separated by the semicolon)] is repeating.	objectNumber

7.3.3.1 JSON Request structure

The table below describes the structure of the JSON request:

No.	Attribute	Type	Obligation	Description
1.	dateFrom	Date	required	The beginning of the reporting period: <ul style="list-style-type: none"> The format: YYYY-MM-DD. The reporting period start date is the first day of the month.
2.	dateTo	Date	required	The end of the reporting period: <ul style="list-style-type: none"> The format: YYYY-MM-DD. The reporting period end date is the last day of the month.
3.	consumptionCategory	String(20)	required	The consumption category. Possible meanings: <ul style="list-style-type: none"> P+; P-; Q+; Q-;
4.	objectNumbers	String	required	Object number.
5.	interval	String	required	Consumption interval. Possible meanings: <ul style="list-style-type: none"> HOUR QUARTER
6.	netBilling: {}			
6.1	intervalData	Boolean	not required	Indication that the object is in "Net billing" accounting scheme. Possible meanings: <ul style="list-style-type: none"> TRUE FALSE NULL Default value is NULL. NULL is treated as False.

6.2	intervalDataRecalculation	Boolean	not required	<p>Indication for the recalculation of objects in the "Net billing" accounting scheme. Possible meanings:</p> <ul style="list-style-type: none"> • TRUE • FALSE • NULL <p>Default value is NULL. NULL is treated as False.</p>
6.3	intervalDataDetailed	Boolean	not required	<p>Indication of whether object in "Net billing" accounting scheme detailed information should be retrieved. Possible meanings:</p> <ul style="list-style-type: none"> • TRUE – a detailed view will be returned (the consumption object and all its power plant objects); • FALSE – a aggregated view will be returned (the consumption object without power plant objects); • NULL. <p>Default value is NULL. NULL is treated as False.</p>

7.3.3.2 JSON Response structure

The table below describes the structure of the JSON response:

No.	Attribute	type	obligation	description
1.	orderId	Integer	required	The report ordering primary surrogate key.

7.3.3.3 Error Response Structure

The following table describes the JSON structure in the event of a response error:

No.	Attribute	type	obligation	description
1.	code	number	required	Error code.
2.	text	string(4000)	required	Error message.

7.3.4 POST/gateway/order/v2/{orderType}

URL	POST/gateway/order/v2/{orderType}		
Description	Method will order the chosen report.		
Parameters	<p>URL parameters:</p> <ul style="list-style-type: none"> • orderType – the method is used for specified report type. <ul style="list-style-type: none"> • bill-2s2s-b2b - Billing report for 2S2S model B2B; • bill-bss-b2b - Billing report for BSS model B2B; • bill-bss-b2c - Billing report for BSS model B2C; • report-obj - Objects report. 		
Header	After decrypting the supplier authentication key, the supplier ID is used to order the report.		
JSON request	<pre>{ "dateFrom": "date", "dateTo": "date", "consumerCode": "string", "personCode": "string", "objectNumbers": ["string"], "contractType": "string" }</pre>		
Response	HTTP status code	Reason	Response description
	201	Created	Request completed successfully
	400	Bad Request	Request error. The HTTP response body provides a list of errors in JSON format.
	401	Unauthorized	An attempt was made to connect to a non-public method that requires authentication, but no user credentials were provided.

	403	Forbidden	According to the access control policy, the current user does not have access to perform the requested action.		
	404	Not Found	Either there is no API method associated with the request URL path, or the request contains one or more parameters that did not return the data.		
JSON Response	<pre>{ "orderId": "number" }</pre>				
JSON error response	<pre>{ "errorMessages": [{ "code": 0, "text": "string" }] }</pre>				
Rules	No.	Rule description	Error code	Error message	Attribute
	0.	If an attribute has defined possible values, the value index can be specified by specifying the value of the attribute in the request. Indices of all possible values start from 0.	-	-	All attributes with specified values.
	1.	The report of the specified object can be ordered only if the object was or is owned for the supplier in the chosen period. Checking whether the objects were valid with the supplier during the specified period.	2001	There are no owned objects for the selected period or other specified search parameters.	dateFrom dateTo consumerCode objectNumber personCode
	2.	One or more request parameters are required.	1001	One or more request parameters are required.	dateFrom dateTo
	3.	The date from cannot be later than the date to. Equal can be.	1002	Date from cannot be later than date to.	dateFrom, dateTo
	4.	The date from cannot be later than the current date but can be equal.	2003	Date from cannot be later than the current date.	dateFrom

		This rule should not apply to a [report-obj] report, as a result of which the data may be later than the current date.			
	5.	Date format is incorrect.	-	-	dateTo dateFrom
	6.	The contract type can be specified only for the Object Data Collection report. The contract type cannot be specified for the other order types.	2008	The search parameter [contractType] is not applicable to the selected report order type.	contractType
	7.	The report order can be done only for one reporting period (one month), if attributes consumerCode, personCode or objectNumbers is not specified. <ul style="list-style-type: none"> This rule cannot be applies for [report-obj] report. 	2011	The report without specifying the consumer code, person code and object number can only be ordered for 1 reporting period.	dateFrom dateTo
	8.	Client information cannot be older than 36 months old.	2012	Date from cannot be older than 36 months old.	dateFrom
	9.	The period dateFrom and dateTo must be less than date from configurable parameter.	2015	Data is not currently available for the selected reporting period.	dateFrom dateTo
	10.	Start and end dates are required.	1005	Dates are required.	dateFrom dateTo
	11.	The object data pack can be ordered 36 months to the future.	2019	The report can be ordered 36 months to the future.	dateTo
	12.	A maximum of 500 objects can be submitted in a report order.	2021	A maximum of 500 objects can be specified.	objectNumber
	13.	If consumerCode and/or personCode and/or objectNumbers are specified, then the report can be ordered for a maximum one year (12 reporting periods). This rule applies to accounting bills: <ul style="list-style-type: none"> bill-2s2s-b2b 	2025	The report with specified parameters can be ordered from 1 to 12 reporting periods.	dateFrom,dateTo, personCode, consumerCode, objectNumbers

- bill-bss-b2b
- bill-bss-b2c

7.3.4.1 JSON Request structure

The table below describes the structure of the JSON response:

Attribute	type	obligation	description
dateFrom	Date	Required	The beginning of the reporting period: <ul style="list-style-type: none"> • The format: YYYY-MM-DD; • The reporting period start date is the first day of the month.
dateTo	Date	Required	The end of the reporting period: <ul style="list-style-type: none"> • The format: YYYY-MM-DD; • The reporting period end date is the last day of the month.
consumerCode	String(20)	Not required	Consumer code.
personCode	String(20)	Not required	Person or the company code.
objectNumbers	String	Not required	Object numbers.
contractType	String(10)	Not required	Contract type. Possible meanings: <ul style="list-style-type: none"> • SKMS; • SBTS.

7.3.4.2 JSON Response structure

The table below describes the structure of the JSON response:

Attribute	type	obligation	description
orderId	Integer	required	Report's order ID.

7.3.4.3 Error Response Structure

The following table describes the JSON structure in the event of a response error:

No.	Attribute	type	obligation	description
1.	code	number	required	Error code.
2.	text	string(4000)	required	Error message.

7.3.5 GET/gateway/order/{orderId}/data-hr-15min-obj-lvl

URL	GET/gateway/order/{orderId}/data-hr-15min-obj-lvl		
Description	The method is designed to obtain fifteen minute / hour report data.		
Parameters	<p>URL parameters:</p> <ul style="list-style-type: none"> • orderId – order identification number • first - the index of the object, which must be the first in the return list (starting from 0). Optional. The default value is 0. • count - the number of objects in the return list. Optional. The default value is 10000. If no count value is given, the default value count will be 10000. 		
Header	After decrypting the supplier authentication key, the supplier ID is used to select the data.		
JSON request	GET request does not have the BODY part.		
Response	HTTP status code	Reason	Response description
	200	OK	Request completed successfully
	204	No content	No data found according to the given parameters.
	400	Bad Request	Request error. The HTTP response body provides a list of errors in JSON format.
	401	Unauthorized	An attempt was made to connect to a non-public method that requires authentication, but no user credentials were provided.
	403	Forbidden	According to the access control policy, the current user does not have access to perform the requested action.

	404	Not Found	Either there is no API method associated with the request URL path, or the request contains one or more parameters that did not return the data.
JSON Response	<pre>[{ "personCode": "string", "personName": "string", "personSurname": "string", "objectId": "number", "objectNumber": "string", "graphVersion": "dateTime", "consumptionCategories": [{ "consumptionCategory": "string", "powerPlantObjectNumber": "string", "powerPlantType": "string", "consumptions": [{ "consumptionTime": "datetime", "amount": "double", "valueType": "string", "usageType": "string" }] }] }]</pre>		
JSON error response	<pre>{ "errorMessages": [{ "code": 0, "text": "string" }] }</pre>		

Rules	No.	Rule description	Error code	Error message	Attribute
	1.	The order status must be Completed.	2010	Invalid report order status.	orderId
	2.	According to the submitted order number: [orderId], the order does not exist.	2016	Report order doesn't exist in the system.	orderId
	3.	Invalid method selected or parameter specified incorrectly. According to the submitted order number: [orderId] report type is: [orderType]	2017	Invalid method selected for report data or incorrect parameter.	orderId orderType
	4.	No data found based on the search parameters submitted in the POST method.	2018	There is no data for the selected search parameters, the response is empty.	orderId
	5.	The number of objects in the return list must be less than or equal to 10000.	2022	The number of objects on the list has been exceeded.	count

7.3.5.1 JSON Request structure

The table below describes the structure of the JSON request:

Attribute	type	obligation	description

7.3.5.2 JSON Response structure

The table below describes the structure of the JSON response:

No.	Attribute	Type	Obligation	Description
1.	consumerCode	String(20)	required	Consumer code.
2.	personName	String(200)	required	Person name / company name.

3.	personSurname	String(50)	required	Person surname.
4.	objectId	Integer	required	Object ID.
5.	objectNumber	String(20)	required	Object number.
6.	graphVersion	DateTime	not required	Calculated version of the "Net billing" accounting scheme graph. Note: Filled in if attributes were selected when ordering the report: intervalData: true .
7.	consumptionCategories: []			
7.1	consumptionCategory	String(20)	required	Consumption category. Possible meanings: <ul style="list-style-type: none"> • P+; • P-; • Q+; • Q-.
7.2	powerPlantObjectNumber	String(20)	not required	Power plant object number, which has "Net billing" accounting scheme. Note: Filled in if attributes were selected when ordering the report: intervalData: true AND intervalDataDetailed: true .
7.3	powerPlantType	String(2)	not required	Type of the power plant. Possible meanings: <ul style="list-style-type: none"> • A – Waste; • B – Biomass; • H – Hydroelectric; • K – Other; • S – Solar; • T – TEC; • V – Wind. Note: Filled in if attributes were selected when ordering the report: intervalData: true AND intervalDataDetailed: true .
8.	consumptions: []			

8.1	consumptionTime	Datetime	required	Consumption time. Example of consumptionTime format: 2022-06-07T00:00:00+02:00 2022-06-07T00:00:00+03:00
8.2	amount	Double	required	Consumption amount in kWh/kVArh.
8.3	valueType	String(3)	required	Consumption value type. Possible meanings: <ul style="list-style-type: none"> • EST – estimated; • VAL – validated.
8.4	usageType	String(1)	not required	Reading usage type (only for object, which has "Net billing" accounting scheme). Possible field values are: <ul style="list-style-type: none"> • B – Billing; • D – Daily <p>Note:</p> <p>Filled in if attributes were selected when ordering the report: intervalData: true.</p>

7.3.5.3 Error Response Structure

The following table describes the JSON structure in the event of a response error:

No.	Attribute	Type	Obligation	Description
1.	code	number	required	Error code.
2.	text	string(4000)	required	Error message.

7.3.6 GET/gateway/order/{orderId}/data-hr-15min-mtr-lvl

URL	GET/gateway/order/{orderId}/data-hr-15min-mtr-lvl		
Description	The method is designed to obtain fifteen minute / hour report data.		
Parameters	<p>URL parameters:</p> <ul style="list-style-type: none"> • orderId – order identification number • first - the index of the object, which must be the first in the return list (starting from 0). Optional. The default value is 0. • count - the number of objects in the return list. Optional. The default value is 10000. If no count value is given, the default value count will be 10000. 		
Header	After decrypting the supplier authentication key, the supplier ID is used to select the data.		
JSON request	GET request does not have the BODY part.		
Response	HTTP status code	Reason	Response description
	200	OK	Request completed successfully
	204	No content	No data found according to the given parameters.
	400	Bad Request	Request error. The HTTP response body provides a list of errors in JSON format.
	401	Unauthorized	An attempt was made to connect to a non-public method that requires authentication, but no user credentials were provided.
	403	Forbidden	According to the access control policy, the current user does not have access to perform the requested action.
	404	Not Found	Either there is no API method associated with the request URL path, or the request contains one or more parameters that did not return the data.
JSON Response	<pre>[{ "personCode": "string",</pre>		

```

"personName":"string",
"personSurname":"string",
"objectId":"number",
"objectNumber":"string",
"meters":[
  {
    "meterNumber":"string",
    "categories":[
      {
        "consumptionCategory":"string",
        "consumptions":[
          {
            "consumptionTime":"datetime",
            "amount":"double",
            "valueType":"string"
          }
        ]
      }
    ]
  }
]

```

JSON error response

```

{
  "errorMessages": [
    {
      "code": 0,
      "text": "string"
    }
  ]
}

```

Rules	No.	Rule description	Error code	Error message	Attribute
	1.	The order status must be Completed.	2010	Invalid report order status.	orderId
	2.	According to the submitted order number: [orderId], the order does not exist.	2016	Report order doesn't exist in the system.	orderId

	3.	Invalid method selected or parameter specified incorrectly. According to the submitted order number: [orderId] report type is: [orderType]	2017	Invalid method selected for report data or incorrect parameter.	orderId orderType
	4.	No data found based on the search parameters submitted in the POST method.	2018	There is no data for the selected search parameters, the response is empty.	orderId
	5.	The number of objects in the return list must be less than or equal to 10000.	2022	The number of objects on the list has been exceeded.	count

7.3.6.1 JSON Request structure

The table below describes the structure of the JSON request:

Attribute	Type	Obligation	Description

7.3.6.2 JSON Response structure

The table below describes the structure of the JSON response:

Attribute	Type	Obligation	Description
consumerCode	String(20)	required	Consumer code.
personName	String(200)	required	Person name / company name.
personSurname	String(50)	required	Person surname.
objectId	Integer	required	Object ID.
objectNumber	String(20)	required	Object number.
meters: []			
meterNumber	String(20)	required	Meter number of the object.

categories: []			
consumptionCategory	String(20)	required	Consumption category. Possible meanings: <ul style="list-style-type: none"> • P+; • P-; • Q+; • Q-.
consumptions: []			
consumptionTime	Datetime	required	Consumption time. Example of consumptionTime format: 2022-06-07T00:00:00+02:00 2022-06-07T00:00:00+03:00
amount	Double	required	Consumption amount in kWh/kVArh.
valueType	String(3)	required	Consumption value type. Possible meanings: <ul style="list-style-type: none"> • EST – estimated; • VAL – validated.

7.3.6.3 Error Response Structure

The following table describes the JSON structure in the event of a response error:

No.	Attribute	Type	Obligation	Description
1.	code	number	required	Error code.
2.	text	string(4000)	required	Error message.

7.3.7 GET/gateway/order/{orderId}/bill-2s2s-b2b

URL	GET/gateway/order/{orderId}/bill-2s2s-b2b
Description	The method is used to obtain 2s2s report data.
Parameters	URL parameters:

	<ul style="list-style-type: none"> • orderId – order identification number; • first - the index of the invoice, which must be the first in the return list (starting from 0). Optional. The default value is 0. • count - the number of invoices in the return list. Optional. The default value is 10000. If no count value is given, the default value count will be 10000. 		
Header	After decrypting the supplier authentication key, the supplier ID is used to select the data.		
JSON request	GET request does not have the BODY part.		
Response	HTTP status code	Reason	Response description
	200	OK	Request completed successfully
	204	No content	No data found according to the given parameters.
	400	Bad Request	Request error. The HTTP response body provides a list of errors in JSON format.
	401	Unauthorized	An attempt was made to connect to a non-public method that requires authentication, but no user credentials were provided.
	403	Forbidden	According to the access control policy, the current user does not have access to perform the requested action.
	404	Not Found	Either there is no API method associated with the request URL path, or the request contains one or more parameters that did not return the data.
JSON Response	<pre>[{ "vatInvoiceNumber":"string", "vatInvoiceSeries":"string", "objects":[{ "contractType":"string", "consumerCode":"string", "personCode":"string", "personName":"string",</pre>		

	<pre> "personSurname": "string", "objectId": "number", "objectNumber": "string", "objectName": "string", "objectType": "string", "objectAddress": "string", "autoMetersAmount": "number", "products": [{ "billingPeriod": "datetime", "permissiblePowerConsumption": "double", "permissiblePowerGeneration": "double", "generatingObjectType": "string", "generatingGroup": "number", "generatingObjectPriorityGroup": "number", "tariffPlan": "string", "productCode": "string", "productName": "string", "productType": "string", "consumptionCategory": "string", "consumptionAmount": "double", "unit": "string", "oldIndependentSupplier": "string", "productConsumptionType": "string" }] </pre>
<p>JSON error response</p>	<pre> { "errorMessages": [{ "code": 0, "text": "string" }] } </pre>

	<pre>] }</pre>				
Rules	No.	Rule description	Error code	Error message	Attribute
	1.	The order status must be Completed.	2010	Invalid report order status.	orderId
	2.	According to the submitted order number: [orderId], the order does not exist.	2016	Report order doesn't exist in the system.	orderId
	3.	Invalid method selected or parameter specified incorrectly. According to the submitted order number: [orderId] report type is: [orderType]	2017	Invalid method selected for report data or incorrect parameter.	orderId orderType
	4.	No data found based on the search parameters submitted in the POST method.	2018	There is no data for the selected search parameters, the response is empty.	orderId

7.3.7.1 JSON Response structure

The table below describes the structure of the JSON response:

Attribute	type	obligation	description
contractType	String(10)	required	Contract type. There are 2 possible values: SKMS SBTS
vatInvoiceNumber	String(25)	required	VAT invoice number.
vatInvoiceSeries	String(10)	required	VAT invoice series.
billingPeriod	datetime	required	Month in which electricity consumption is recorded.
consumerCode	String(20)	required	Consumer code.
generatingObjectType	String(5)	required	Generating consumer type. Possible meanings:

			G – GV (Generating consumer); N – NGV (Distant generating consumer).
personCode	String(20)	required	Contract owner / tenant person / company code.
name	String(200)	required	Contract owner / tenant name / company name.
surname	String(50)	Not required	Contract owner / tenant surname.
objectId	Number	required	Object Id.
objectNumber	String(20)	required	Object number.
objectName	String(200)	required	Object name.
objectType	String(200)	required	Object type.
objectAddress	String(4000)	required	Object address.
permissiblePowerConsumption	Double(10,3)	required	Permissible power consumption in the object, kW.
permissiblePowerGeneration	Double(10,3)	required	Permissible power generation in the object, kW.
autoMetersAmount	Number	required	Total number of remotely readable or smart metering devices installed at the object.
oldIndependentSupplier	String(200)	required	Previous supplier of the object.
generatingGroup	Number	not required	The group identifier of the generating user.
generatingObjectPriorityGroup	Number	not required	The priority of the generating user group object.
tariffPlan	String(250)	required	The tariff plan of object.
productCode	String(20)	required	The code of product.
productName	String(4000)	required	The product name.
productType	String(5)	required	Product type.

consumptionCategory	String(2)	required	Category of the consumption energy
consumptionAmount	Number	required	The amount of the consumption
unit	String(255)	required	The unit of the product.
productConsumptionType	String (20)	not required	Type of the product consumption. Possible meanings: <ul style="list-style-type: none"> - AMS - Subscription fee; - FGS - Contractual fixed power consumption parameters; - GGS - Generated power; - LGS - Permissible power; - REPS - Contractual reactive electricity parameters; - SPA - According to the act; - SPR - According to readings; - STA - According to rules; - TSPS - Contractual technological cost parameters; - VAP - VIAP accounting parameters; - SPP - According to parameters.

7.3.7.2 Error Response Structure

The following table describes the JSON structure in the event of a response error:

No.	Attribute	type	obligation	description
1.	code	number	required	Error code.
2.	text	string(4000)	required	Error message.

7.3.8 GET/gateway/order/v2/{orderId}/report-obj

URL	GET/gateway/order/v2/{orderId}/report-obj
Description	The method is used to obtain objects report data.
Parameters	<p>URL parameters:</p> <ul style="list-style-type: none"> • orderId – order identification number; • first - the index of the report line, which must be the first in the return list (starting from 0). Optional. The default value is 0;

	<ul style="list-style-type: none"> count - the number of report rows in the return list. Optional. The default value is 10000. If no count value is given, the default value count will be 10000. 		
Header	After decrypting the supplier authentication key, the supplier ID is used to select the data.		
JSON request	GET request does not have the BODY part.		
Response	HTTP status code	Reason	Response description
	200	OK	Request completed successfully
	204	No content	No data found according to the given parameters.
	400	Bad Request	Request error. The HTTP response body provides a list of errors in JSON format.
	401	Unauthorized	An attempt was made to connect to a non-public method that requires authentication, but no user credentials were provided.
	403	Forbidden	According to the access control policy, the current user does not have access to perform the requested action.
	404	Not Found	Either there is no API method associated with the request URL path, or the request contains one or more parameters that did not return the data.
JSON Response	<pre>[{ "consumerCode":"string", "personCode":"string", "personName":"string", "personSurname":"string", "objectId":"number", "objectNumber":"string", "objectName":"string", "objectType":"string", "objectAddress":"string", "contractType":"string", "contractModel":"string", "contractStart":"date", "contractEnd":"date", "supplierChangeNotificationSubmittedDate":"date",</pre>		

	<pre> "permissiblePowerConsumption": "double", "permissiblePowerGeneration": "double", "metersAmount": "number", "autoMetersAmount": "number", "smartMeterInstallationDate": "date", "supplyState": "string", "supplyStateFrom": "date", "supplyStateTo": "date", "consumptionState": "string", "consumptionStateFrom": "date", "consumptionStateTo": "date", "productsAmount": "number", "scalesAmount": "number", "technologicalCosts": "boolean", "payoffMethod": "string", "payoffMethodChangeDate": "date", "generatingObjectType": "string", "generatingObjectTypeFrom": "date", "generatingObjectTypeTo": "date", "powerPlantObjects": [{ "powerPlantObjectNumber": "string", "powerPlantType": "string" }], "generatingObjectPower": "double", "voltage": "double", "tariffPlan": "string", "tariffPlanChangeDate": "date", "timeZone": "string", "consumptionAverage": "double", "consumptionAverageCalculationDate": "datetime", "consumptionAverageCalculationMonthsCount": "integer", "sociallyVulnerable": "boolean" }] </pre>
<p>JSON error response</p>	<pre> { "errorMessages": [{ "code": 0, "text": "string" }] } </pre>

	<pre> }] } </pre>				
Rules	No.	Rule description	Error code	Error message	Attribute
	1.	The order status must be Completed.	2010	Invalid report order status.	orderId
	2.	According to the submitted order number: [orderId], the order does not exist.	2016	Report order doesn't exist in the system.	orderId
	3.	Invalid method selected or parameter specified incorrectly. According to the submitted order number: [orderId] report type is: [orderType]	2017	Invalid method selected for report data or incorrect parameter.	orderId orderType
	4.	No data found based on the search parameters submitted in the POST method.	2018	There is no data for the selected search parameters, the response is empty.	orderId

7.3.8.1 JSON Response structure

The table below describes the structure of the JSON response:

Attribute	type	obligation	description
-	-	-	Response description are provided in https://datahub.eso.lt/dokumentacija . In next document version, all fields description will be provided here.

7.3.8.2 Error Response Structure

The following table describes the JSON structure in the event of a response error:

No.	Attribute	type	obligation	description
1.	code	number	required	Error code.
2.	text	string(4000)	required	Error message.

7.3.9 GET/gateway/order/{orderId}/bill-bss-b2c

URL	GET/gateway/order/{orderId}/bill-bss-b2c		
Description	The method is used to obtain b2c report data.		
Parameters	<p>URL parameters:</p> <ul style="list-style-type: none"> • orderId – order identification number. • first - the index of the report line, which must be the first in the return list (starting from 0). Optional. The default value is 0. • count - the number of report rows in the return list. Optional. The default value is 30. 		
Header	After decrypting the supplier authentication key, the supplier ID is used to select the data.		
JSON request	GET request does not have the BODY part.		
Response	HTTP status code	Reason	Response description
	200	OK	Request completed successfully
	204	No content	No data found according to the given parameters.
	400	Bad Request	Request error. The HTTP response body provides a list of errors in JSON format.
	401	Unauthorized	An attempt was made to connect to a non-public method that requires authentication, but no user credentials were provided.
	403	Forbidden	According to the access control policy, the current user does not have access to perform the requested action.
	404	Not Found	Either there is no API method associated with the request URL path, or the request contains one or more parameters that did not return the data.
JSON Response	<pre>[{ "customerId": "string", "clientId": "string", "clientName": "string", "clientAddress": "string",</pre>		

```
"objectId": 0,
"objectNumber": "string",
"objectName": "string",
"objectType": "string",
"generatingCustomer": true,
"objectAddress": "string",
"agreementType": "string",
"agreementModel": "string",
"agreementFrom": "2020-09-21",
"agreementTo": "2020-09-21",
"generatingGroup": 0,
"generatingObjectPriorityGroup": 0,
"permissiblePowerConsumption": 0,
"permissiblePowerGeneration": 0,
"installedGeneratingPower": 0,
"installedConsumptionPower": 0,
"metersAmount": 0,
"autoMetersAmount": 0,
"reportingPeriod": "2020-09-21",
"billingPeriod": "2020-09-21",
"supplyState": "string",
"supplyStateFrom": "2020-09-21",
"supplyStateTo": "2020-09-21",
"metersNumber": "string",
"readingsSource": "string",
"readingsReceiveDate": "2020-09-21",
"paymentType": "string",
"service": "string",
"declarationReferenceType": "string",
"referenceSubmitDate": "2020-09-21",
"readingsSubmitDate": "2020-09-21",
"declarationReferenceNumber": 0,
"unaccountedConsumptionActNumber": 0,
"unaccountedConsumptionActCreateDate": "2020-09-21",
"unaccountedConsumptionActFrom": "2020-09-21",
"unaccountedConsumptionActTo": "2020-09-21",
"consumptionConversionActNumber": "string",
"consumptionConversionActCreateDate": "2020-09-21",
"consumptionConversionActFrom": "2020-09-21",
"consumptionConversionActTo": "2020-09-21",
"consumptionState": "string",
"consumptionStateFrom": "2020-09-21",
```

"consumptionStateTo": "2020-09-21",
"tariffPlan": "string",
"tariffPlanChangeDate": "2020-09-21",
"consumptionConversionAct": true,
"powerPlantCapacityDateFrom": "2020-09-21",
"energyObtainedDateFrom": "2020-09-21",
"powerPlantCapacityDateTo": "2020-09-21",
"energyObtainedDateTo": "2020-09-21",
"energyObtainedPowerKw": 0,
"operatorGridElectricityPercent": 0,
"clientGridElectricityPercent": 0,
"vkConsumptionAmount": 0,
"vkViapConsumptionAmount": 0,
"vkSppdConsumptionAmount": 0,
"ddConsumptionAmount": 0,
"ddViapConsumptionAmount": 0,
"ddSppdConsumptionAmount": 0,
"nkConsumptionAmount": 0,
"nkViapConsumptionAmount": 0,
"nkSppdConsumptionAmount": 0,
"n2ConsumptionAmount": 0,
"n2ViapConsumptionAmount": 0,
"n2SppdConsumptionAmount": 0,
"d1ConsumptionAmount": 0,
"d1ViapConsumptionAmount": 0,
"d1SppdConsumptionAmount": 0,
"d2ConsumptionAmount": 0,
"d2ViapConsumptionAmount": 0,
"d2SppdConsumptionAmount": 0,
"n1ConsumptionAmount": 0,
"n1ViapConsumptionAmount": 0,
"n1SppdConsumptionAmount": 0,
"vkConsumedElectricityConsumptionAmount": 0,
"ddConsumedElectricityConsumptionAmount": 0,
"nkConsumedElectricityConsumptionAmount": 0,
"n2ConsumedElectricityConsumptionAmount": 0,
"d1ConsumedElectricityConsumptionAmount": 0,
"d2ConsumedElectricityConsumptionAmount": 0,
"n1ConsumedElectricityConsumptionAmount": 0,
"vkPayingRecoveredEnergyConsumptionAmount": 0,
"ddPayingRecoveredEnergyConsumptionAmount": 0,
"nkPayingRecoveredEnergyConsumptionAmount": 0,

"n2PayingRecoveredEnergyConsumptionAmount": 0,
"d1PayingRecoveredEnergyConsumptionAmount": 0,
"d2PayingRecoveredEnergyConsumptionAmount": 0,
"n1PayingRecoveredEnergyConsumptionAmount": 0,
"vkPayingRecoveredPercentConsumptionAmount": 0,
"ddPayingRecoveredPercentConsumptionAmount": 0,
"nkPayingRecoveredPercentConsumptionAmount": 0,
"n2PayingRecoveredPercentConsumptionAmount": 0,
"d1PayingRecoveredPercentConsumptionAmount": 0,
"d2PayingRecoveredPercentConsumptionAmount": 0,
"n1PayingRecoveredPercentConsumptionAmount": 0,
"vkPayingRecoveredPowerConsumptionAmount": 0,
"ddPayingRecoveredPowerConsumptionAmount": 0,
"nkPayingRecoveredPowerConsumptionAmount": 0,
"n2PayingRecoveredPowerConsumptionAmount": 0,
"d1PayingRecoveredPowerConsumptionAmount": 0,
"d2PayingRecoveredPowerConsumptionAmount": 0,
"n1PayingRecoveredPowerConsumptionAmount": 0,
"vkPayingRecoveredMixedConsumptionAmount": 0,
"ddPayingRecoveredMixedConsumptionAmount": 0,
"nkPayingRecoveredMixedConsumptionAmount": 0,
"n2PayingRecoveredMixedConsumptionAmount": 0,
"d1PayingRecoveredMixedConsumptionAmount": 0,
"d2PayingRecoveredMixedConsumptionAmount": 0,
"n1PayingRecoveredMixedConsumptionAmount": 0,
"vkMissingEnergyConsumptionAmount": 0,
"vkMissingEnergyViapConsumptionAmount": 0,
"vkMissingEnergySppdConsumptionAmount": 0,
"ddMissingEnergyConsumptionAmount": 0,
"ddMissingEnergyViapConsumptionAmount": 0,
"ddMissingEnergySppdConsumptionAmount": 0,
"nkMissingEnergyConsumptionAmount": 0,
"nkMissingEnergyViapConsumptionAmount": 0,
"nkMissingEnergySppdConsumptionAmount": 0,
"n2MissingEnergyConsumptionAmount": 0,
"n2MissingEnergyViapConsumptionAmount": 0,
"n2MissingEnergySppdConsumptionAmount": 0,
"d1MissingEnergyConsumptionAmount": 0,
"d1MissingEnergyViapConsumptionAmount": 0,
"d1MissingEnergySppdConsumptionAmount": 0,
"d2MissingEnergyConsumptionAmount": 0,
"d2MissingEnergyViapConsumptionAmount": 0,

"d2MissingEnergySppdConsumptionAmount": 0,
"n1MissingEnergyConsumptionAmount": 0,
"n1MissingEnergyViapConsumptionAmount": 0,
"n1MissingEnergySppdConsumptionAmount": 0,
"gridSuppliedConsumptionAmount": 0,
"accumulatedBeginningConsumptionAmount": 0,
"accumulatedEndConsumptionAmount": 0,
"accumulatedUploadedConsumptionAmount": 0,
"accumulatedRaisedConsumptionAmount": 0,
"compensatedConsumptionAmount": 0,
"oldIndependentSupplier": "string",
"powerPlantCapacityConsumptionAmount": 0,
"energyObtainedConsumptionAmount": 0,
"operatorGridElectricityConsumptionAmount": 0,
"clientGridElectricityConsumptionAmount": 0,
"vkUnit": "string",
"vkViapUnit": "string",
"vkSppdUnit": "string",
"ddUnit": "string",
"ddViapUnit": "string",
"ddSppdUnit": "string",
"nkUnit": "string",
"nkViapUnit": "string",
"nkSppdUnit": "string",
"n2Unit": "string",
"n2ViapUnit": "string",
"n2SppdUnit": "string",
"d1Unit": "string",
"d1ViapUnit": "string",
"d1SppdUnit": "string",
"d2Unit": "string",
"d2ViapUnit": "string",
"d2SppdUnit": "string",
"n1Unit": "string",
"n1ViapUnit": "string",
"n1SppdUnit": "string",
"vkConsumedElectricityUnit": "string",
"ddConsumedElectricityUnit": "string",
"nkConsumedElectricityUnit": "string",
"n2ConsumedElectricityUnit": "string",
"d1ConsumedElectricityUnit": "string",
"d2ConsumedElectricityUnit": "string",

"n1ConsumedElectricityUnit": "string",
"vkPayingRecoveredEnergyUnit": "string",
"ddPayingRecoveredEnergyUnit": "string",
"nkPayingRecoveredEnergyUnit": "string",
"n2PayingRecoveredEnergyUnit": "string",
"d1PayingRecoveredEnergyUnit": "string",
"d2PayingRecoveredEnergyUnit": "string",
"n1PayingRecoveredEnergyUnit": "string",
"vkPayingRecoveredPercentUnit": "string",
"ddPayingRecoveredPercentUnit": "string",
"nkPayingRecoveredPercentUnit": "string",
"n2PayingRecoveredPercentUnit": "string",
"d1PayingRecoveredPercentUnit": "string",
"d2PayingRecoveredPercentUnit": "string",
"n1PayingRecoveredPercentUnit": "string",
"vkPayingRecoveredPowerUnit": "string",
"ddPayingRecoveredPowerUnit": "string",
"nkPayingRecoveredPowerUnit": "string",
"n2PayingRecoveredPowerUnit": "string",
"d1PayingRecoveredPowerUnit": "string",
"d2PayingRecoveredPowerUnit": "string",
"n1PayingRecoveredPowerUnit": "string",
"vkPayingRecoveredMixedUnit": "string",
"ddPayingRecoveredMixedUnit": "string",
"nkPayingRecoveredMixedUnit": "string",
"n2PayingRecoveredMixedUnit": "string",
"d1PayingRecoveredMixedUnit": "string",
"d2PayingRecoveredMixedUnit": "string",
"n1PayingRecoveredMixedUnit": "string",
"vkMissingEnergyUnit": "string",
"vkMissingEnergyViapUnit": "string",
"vkMissingEnergySppdUnit": "string",
"ddMissingEnergyUnit": "string",
"ddMissingEnergyViapUnit": "string",
"ddMissingEnergySppdUnit": "string",
"nkMissingEnergyUnit": "string",
"nkMissingEnergyViapUnit": "string",
"nkMissingEnergySppdUnit": "string",
"n2MissingEnergyUnit": "string",
"n2MissingEnergyViapUnit": "string",
"n2MissingEnergySppdUnit": "string",
"d1MissingEnergyUnit": "string",

"d1MissingEnergyViapUnit": "string",
"d1MissingEnergySppdUnit": "string",
"d2MissingEnergyUnit": "string",
"d2MissingEnergyViapUnit": "string",
"d2MissingEnergySppdUnit": "string",
"n1MissingEnergyUnit": "string",
"n1MissingEnergyViapUnit": "string",
"n1MissingEnergySppdUnit": "string",
"vkReadingsFrom": 0,
"ddReadingsFrom": 0,
"nkReadingsFrom": 0,
"n2ReadingsFrom": 0,
"d1ReadingsFrom": 0,
"d2ReadingsFrom": 0,
"n1ReadingsFrom": 0,
"vkConsumedElectricityReadingsFrom": 0,
"ddConsumedElectricityReadingsFrom": 0,
"nkConsumedElectricityReadingsFrom": 0,
"n2ConsumedElectricityReadingsFrom": 0,
"d1ConsumedElectricityReadingsFrom": 0,
"d2ConsumedElectricityReadingsFrom": 0,
"n1ConsumedElectricityReadingsFrom": 0,
"gridSuppliedReadingsFrom": 0,
"vkReadingsTo": 0,
"ddReadingsTo": 0,
"nkReadingsTo": 0,
"n2ReadingsTo": 0,
"d1ReadingsTo": 0,
"d2ReadingsTo": 0,
"n1ReadingsTo": 0,
"vkConsumedElectricityReadingsTo": 0,
"ddConsumedElectricityReadingsTo": 0,
"nkConsumedElectricityReadingsTo": 0,
"n2ConsumedElectricityReadingsTo": 0,
"d1ConsumedElectricityReadingsTo": 0,
"d2ConsumedElectricityReadingsTo": 0,
"n1ConsumedElectricityReadingsTo": 0,
"gridSuppliedReadingsTo": 0,
"vkPriceEur": 0,
"vkViapPriceEur": 0,
"vkSppdPriceEur": 0,
"ddPriceEur": 0,

"ddViapPriceEur": 0,
"ddSppdPriceEur": 0,
"nkPriceEur": 0,
"nkViapPriceEur": 0,
"nkSppdPriceEur": 0,
"n2PriceEur": 0,
"n2ViapPriceEur": 0,
"n2SppdPriceEur": 0,
"d1PriceEur": 0,
"d1ViapPriceEur": 0,
"d1SppdPriceEur": 0,
"d2PriceEur": 0,
"d2ViapPriceEur": 0,
"d2SppdPriceEur": 0,
"n1PriceEur": 0,
"n1ViapPriceEur": 0,
"n1SppdPriceEur": 0,
"vkPayingRecoveredEnergyPriceEur": 0,
"ddPayingRecoveredEnergyPriceEur": 0,
"nkPayingRecoveredEnergyPriceEur": 0,
"n2PayingRecoveredEnergyPriceEur": 0,
"d1PayingRecoveredEnergyPriceEur": 0,
"d2PayingRecoveredEnergyPriceEur": 0,
"n1PayingRecoveredEnergyPriceEur": 0,
"vkPayingRecoveredMixedPriceEur": 0,
"ddPayingRecoveredMixedPriceEur": 0,
"nkPayingRecoveredMixedPriceEur": 0,
"n2PayingRecoveredMixedPriceEur": 0,
"d1PayingRecoveredMixedPriceEur": 0,
"d2PayingRecoveredMixedPriceEur": 0,
"n1PayingRecoveredMixedPriceEur": 0,
"vkMissingEnergyPriceEur": 0,
"vkMissingEnergyViapPriceEur": 0,
"vkMissingEnergySppdPriceEur": 0,
"ddMissingEnergyPriceEur": 0,
"ddMissingEnergyViapPriceEur": 0,
"ddMissingEnergySppdPriceEur": 0,
"nkMissingEnergyPriceEur": 0,
"nkMissingEnergyViapPriceEur": 0,
"nkMissingEnergySppdPriceEur": 0,
"n2MissingEnergyPriceEur": 0,
"n2MissingEnergyViapPriceEur": 0,

"n2MissingEnergySppdPriceEur": 0,
"d1MissingEnergyPriceEur": 0,
"d1MissingEnergyViapPriceEur": 0,
"d1MissingEnergySppdPriceEur": 0,
"d2MissingEnergyPriceEur": 0,
"d2MissingEnergyViapPriceEur": 0,
"d2MissingEnergySppdPriceEur": 0,
"n1MissingEnergyPriceEur": 0,
"n1MissingEnergyViapPriceEur": 0,
"n1MissingEnergySppdPriceEur": 0,
"powerPlantCapacityPriceEur": 0,
"vkPriceEurVAT": 0,
"vkViapPriceEurVAT": 0,
"vkSppdPriceEurVAT": 0,
"ddPriceEurVAT": 0,
"ddViapPriceEurVAT": 0,
"ddSppdPriceEurVAT": 0,
"nkPriceEurVAT": 0,
"nkViapPriceEurVAT": 0,
"nkSppdPriceEurVAT": 0,
"n2PriceEurVAT": 0,
"n2ViapPriceEurVAT": 0,
"n2SppdPriceEurVAT": 0,
"d1PriceEurVAT": 0,
"d1ViapPriceEurVAT": 0,
"d1SppdPriceEurVAT": 0,
"d2PriceEurVAT": 0,
"d2ViapPriceEurVAT": 0,
"d2SppdPriceEurVAT": 0,
"n1PriceEurVAT": 0,
"n1ViapPriceEurVAT": 0,
"n1SppdPriceEurVAT": 0,
"vkPayingRecoveredEnergyPriceEurVAT": 0,
"ddPayingRecoveredEnergyPriceEurVAT": 0,
"nkPayingRecoveredEnergyPriceEurVAT": 0,
"n2PayingRecoveredEnergyPriceEurVAT": 0,
"d1PayingRecoveredEnergyPriceEurVAT": 0,
"d2PayingRecoveredEnergyPriceEurVAT": 0,
"n1PayingRecoveredEnergyPriceEurVAT": 0,
"vkPayingRecoveredMixedPriceEurVAT": 0,
"ddPayingRecoveredMixedPriceEurVAT": 0,
"nkPayingRecoveredMixedPriceEurVAT": 0,

"n2PayingRecoveredMixedPriceEurVAT": 0,
"d1PayingRecoveredMixedPriceEurVAT": 0,
"d2PayingRecoveredMixedPriceEurVAT": 0,
"n1PayingRecoveredMixedPriceEurVAT": 0,
"vkMissingEnergyPriceEurVAT": 0,
"vkMissingEnergyViapPriceEurVAT": 0,
"vkMissingEnergySppdPriceEurVAT": 0,
"ddMissingEnergyPriceEurVAT": 0,
"ddMissingEnergyViapPriceEurVAT": 0,
"ddMissingEnergySppdPriceEurVAT": 0,
"nkMissingEnergyPriceEurVAT": 0,
"nkMissingEnergyViapPriceEurVAT": 0,
"nkMissingEnergySppdPriceEurVAT": 0,
"n2MissingEnergyPriceEurVAT": 0,
"n2MissingEnergyViapPriceEurVAT": 0,
"n2MissingEnergySppdPriceEurVAT": 0,
"d1MissingEnergyPriceEurVAT": 0,
"d1MissingEnergyViapPriceEurVAT": 0,
"d1MissingEnergySppdPriceEurVAT": 0,
"d2MissingEnergyPriceEurVAT": 0,
"d2MissingEnergyViapPriceEurVAT": 0,
"d2MissingEnergySppdPriceEurVAT": 0,
"n1MissingEnergyPriceEurVAT": 0,
"n1MissingEnergyViapPriceEurVAT": 0,
"n1MissingEnergySppdPriceEurVAT": 0,
"powerPlantCapacityPriceEurVAT": 0,
"vkDiscount": 0,
"vkViapDiscount": 0,
"vkSppdDiscount": 0,
"ddDiscount": 0,
"ddViapDiscount": 0,
"ddSppdDiscount": 0,
"nkDiscount": 0,
"nkViapDiscount": 0,
"nkSppdDiscount": 0,
"n2Discount": 0,
"n2ViapDiscount": 0,
"n2SppdDiscount": 0,
"d1Discount": 0,
"d1ViapDiscount": 0,
"d1SppdDiscount": 0,
"d2Discount": 0,

"d2ViapDiscount": 0,
"d2SppdDiscount": 0,
"n1Discount": 0,
"n1ViapDiscount": 0,
"n1SppdDiscount": 0,
"vkPayingRecoveredEnergyDiscount": 0,
"vkPayingRecoveredMixedDiscount": 0,
"vkMissingEnergyDiscount": 0,
"vkMissingEnergyViapDiscount": 0,
"vkMissingEnergySppdDiscount": 0,
"fixedFeeAmountNoVAT": 0,
"vkAmountNoVAT": 0,
"vkViapAmountNoVAT": 0,
"vkSppdAmountNoVAT": 0,
"ddAmountNoVAT": 0,
"ddViapAmountNoVAT": 0,
"ddSppdAmountNoVAT": 0,
"nkAmountNoVAT": 0,
"nkViapAmountNoVAT": 0,
"nkSppdAmountNoVAT": 0,
"n2AmountNoVAT": 0,
"n2ViapAmountNoVAT": 0,
"n2SppdAmountNoVAT": 0,
"d1AmountNoVAT": 0,
"d1ViapAmountNoVAT": 0,
"d1SppdAmountNoVAT": 0,
"d2AmountNoVAT": 0,
"d2ViapAmountNoVAT": 0,
"d2SppdAmountNoVAT": 0,
"n1AmountNoVAT": 0,
"n1ViapAmountNoVAT": 0,
"n1SppdAmountNoVAT": 0,
"vkPayingRecoveredEnergyAmountNoVAT": 0,
"ddPayingRecoveredEnergyAmountNoVAT": 0,
"nkPayingRecoveredEnergyAmountNoVAT": 0,
"n2PayingRecoveredEnergyAmountNoVAT": 0,
"d1PayingRecoveredEnergyAmountNoVAT": 0,
"d2PayingRecoveredEnergyAmountNoVAT": 0,
"n1PayingRecoveredEnergyAmountNoVAT": 0,
"vkPayingRecoveredMixedAmountNoVAT": 0,
"ddPayingRecoveredMixedAmountNoVAT": 0,
"nkPayingRecoveredMixedAmountNoVAT": 0,

"n2PayingRecoveredMixedAmountNoVAT": 0,
"d1PayingRecoveredMixedAmountNoVAT": 0,
"d2PayingRecoveredMixedAmountNoVAT": 0,
"n1PayingRecoveredMixedAmountNoVAT": 0,
"vkMissingEnergyAmountNoVAT": 0,
"vkMissingEnergyViapAmountNoVAT": 0,
"vkMissingEnergySppdAmountNoVAT": 0,
"ddMissingEnergyAmountNoVAT": 0,
"ddMissingEnergyViapAmountNoVAT": 0,
"ddMissingEnergySppdAmountNoVAT": 0,
"nkMissingEnergyAmountNoVAT": 0,
"nkMissingEnergyViapAmountNoVAT": 0,
"nkMissingEnergySppdAmountNoVAT": 0,
"n2MissingEnergyAmountNoVAT": 0,
"n2MissingEnergyViapAmountNoVAT": 0,
"n2MissingEnergySppdAmountNoVAT": 0,
"d1MissingEnergyAmountNoVAT": 0,
"d1MissingEnergyViapAmountNoVAT": 0,
"d1MissingEnergySppdAmountNoVAT": 0,
"d2MissingEnergyAmountNoVAT": 0,
"d2MissingEnergyViapAmountNoVAT": 0,
"d2MissingEnergySppdAmountNoVAT": 0,
"n1MissingEnergyAmountNoVAT": 0,
"n1MissingEnergyViapAmountNoVAT": 0,
"n1MissingEnergySppdAmountNoVAT": 0,
"powerPlantCapacityAmountNoVAT": 0,
"fixedFeeAmount": 0,
"vkAmount": 0,
"vkViapAmount": 0,
"vkSppdAmount": 0,
"ddAmount": 0,
"ddViapAmount": 0,
"ddSppdAmount": 0,
"nkAmount": 0,
"nkViapAmount": 0,
"nkSppdAmount": 0,
"n2Amount": 0,
"n2ViapAmount": 0,
"n2SppdAmount": 0,
"d1Amount": 0,
"d1ViapAmount": 0,
"d1SppdAmount": 0,

"d2Amount": 0,
"d2ViapAmount": 0,
"d2SppdAmount": 0,
"n1Amount": 0,
"n1ViapAmount": 0,
"n1SppdAmount": 0,
"vkPayingRecoveredEnergyAmount": 0,
"ddPayingRecoveredEnergyAmount": 0,
"nkPayingRecoveredEnergyAmount": 0,
"n2PayingRecoveredEnergyAmount": 0,
"d1PayingRecoveredEnergyAmount": 0,
"d2PayingRecoveredEnergyAmount": 0,
"n1PayingRecoveredEnergyAmount": 0,
"vkPayingRecoveredMixedAmount": 0,
"ddPayingRecoveredMixedAmount": 0,
"nkPayingRecoveredMixedAmount": 0,
"n2PayingRecoveredMixedAmount": 0,
"d1PayingRecoveredMixedAmount": 0,
"d2PayingRecoveredMixedAmount": 0,
"n1PayingRecoveredMixedAmount": 0,
"vkMissingEnergyAmount": 0,
"vkMissingEnergyViapAmount": 0,
"vkMissingEnergySppdAmount": 0,
"ddMissingEnergyAmount": 0,
"ddMissingEnergyViapAmount": 0,
"ddMissingEnergySppdAmount": 0,
"nkMissingEnergyAmount": 0,
"nkMissingEnergyViapAmount": 0,
"nkMissingEnergySppdAmount": 0,
"n2MissingEnergyAmount": 0,
"n2MissingEnergyViapAmount": 0,
"n2MissingEnergySppdAmount": 0,
"d1MissingEnergyAmount": 0,
"d1MissingEnergyViapAmount": 0,
"d1MissingEnergySppdAmount": 0,
"d2MissingEnergyAmount": 0,
"d2MissingEnergyViapAmount": 0,
"d2MissingEnergySppdAmount": 0,
"n1MissingEnergyAmount": 0,
"n1MissingEnergyViapAmount": 0,
"n1MissingEnergySppdAmount": 0,
"powerPlantCapacityAmount": 0,

"fixedFeeIncludedVAT": "string",
"vkIncludedVAT": "string",
"vkViapIncludedVAT": "string",
"vkSppdIncludedVAT": "string",
"ddIncludedVAT": "string",
"ddViapIncludedVAT": "string",
"ddSppdIncludedVAT": "string",
"nkIncludedVAT": "string",
"nkViapIncludedVAT": "string",
"nkSppdIncludedVAT": "string",
"n2IncludedVAT": "string",
"n2ViapIncludedVAT": "string",
"n2SppdIncludedVAT": "string",
"d1IncludedVAT": "string",
"d1ViapIncludedVAT": "string",
"d1SppdIncludedVAT": "string",
"d2IncludedVAT": "string",
"d2ViapIncludedVAT": "string",
"d2SppdIncludedVAT": "string",
"n1IncludedVAT": "string",
"n1ViapIncludedVAT": "string",
"n1SppdIncludedVAT": "string",
"vkPayingRecoveredEnergyIncludedVAT": "string",
"ddPayingRecoveredEnergyIncludedVAT": "string",
"nkPayingRecoveredEnergyIncludedVAT": "string",
"n2PayingRecoveredEnergyIncludedVAT": "string",
"d1PayingRecoveredEnergyIncludedVAT": "string",
"d2PayingRecoveredEnergyIncludedVAT": "string",
"n1PayingRecoveredEnergyIncludedVAT": "string",
"vkPayingRecoveredMixedIncludedVAT": "string",
"ddPayingRecoveredMixedIncludedVAT": "string",
"nkPayingRecoveredMixedIncludedVAT": "string",
"n2PayingRecoveredMixedIncludedVAT": "string",
"d1PayingRecoveredMixedIncludedVAT": "string",
"d2PayingRecoveredMixedIncludedVAT": "string",
"n1PayingRecoveredMixedIncludedVAT": "string",
"vkMissingEnergyIncludedVAT": "string",
"vkMissingEnergyViapIncludedVAT": "string",
"vkMissingEnergySppdIncludedVAT": "string",
"ddMissingEnergyIncludedVAT": "string",
"ddMissingEnergyViapIncludedVAT": "string",
"ddMissingEnergySppdIncludedVAT": "string",

	<pre>"nkMissingEnergyIncludedVAT": "string", "nkMissingEnergyViapIncludedVAT": "string", "nkMissingEnergySppdIncludedVAT": "string", "n2MissingEnergyIncludedVAT": "string", "n2MissingEnergyViapIncludedVAT": "string", "n2MissingEnergySppdIncludedVAT": "string", "d1MissingEnergyIncludedVAT": "string", "d1MissingEnergyViapIncludedVAT": "string", "d1MissingEnergySppdIncludedVAT": "string", "d2MissingEnergyIncludedVAT": "string", "d2MissingEnergyViapIncludedVAT": "string", "d2MissingEnergySppdIncludedVAT": "string", "n1MissingEnergyIncludedVAT": "string", "n1MissingEnergyViapIncludedVAT": "string", "n1MissingEnergySppdIncludedVAT": "string", "powerPlantCapacityIncludedVAT": "string", "powerPlantCapacityUnit": "string" }]</pre>				
JSON error response	<pre>{ "errorMessages": [{ "code": 0, "text": "string" }] }</pre>				
Rules	No.	Rule description	Error code	Error message	Attribute
	1.	The order status must be Completed.	2010	Invalid report order status.	orderId
	2.	According to the submitted order number: [orderId], the order does not exist.	2016	Report order doesn't exist in the system.	orderId
	3.	Invalid method selected or parameter specified incorrectly. According to the submitted order number: [orderId] report type is: [orderType]	2017	Invalid method selected for report data or incorrect parameter.	orderId orderType

	4.	No data found based on the search parameters submitted in the POST method.	2018	There is no data for the selected search parameters, the response is empty.	orderId
	5.	The number of objects in the return list must be less than or equal to 10000.	2022	The number of objects on the list has been exceeded.	count

7.3.9.1 JSON Response structure

The table below describes the structure of the JSON response:

Attribute	type	obligation	description
-	-	-	Response description are provided in additional documentation . In next document version, all fields description will be provided here.

7.3.9.2 Error Response Structure

The following table describes the JSON structure in the event of a response error:

No.	Attribute	type	obligation	description
1.	code	number	required	Error code.
2.	text	string(4000)	required	Error message.

7.3.10 GET/gateway/order/{orderId}/bill-bss-b2b

URL	GET/gateway/order/{orderId}/bill-bss-b2b
Description	The method is used to obtain b2b report data.
Parameters	<p>URL parameters:</p> <ul style="list-style-type: none"> orderId – order identification number.

	<ul style="list-style-type: none"> • first - the index of the report line, which must be the first in the return list (starting from 0). Optional. The default value is 0. • count - the number of report rows in the return list. Optional. The default value is 30. 		
Header	After decrypting the supplier authentication key, the supplier ID is used to select the data.		
JSON request	GET request does not have the BODY part.		
Response	HTTP status code	Reason	Response description
	200	OK	Request completed successfully
	204	No content	No data found according to the given parameters.
	400	Bad Request	Request error. The HTTP response body provides a list of errors in JSON format.
	401	Unauthorized	An attempt was made to connect to a non-public method that requires authentication, but no user credentials were provided.
	403	Forbidden	According to the access control policy, the current user does not have access to perform the requested action.
	404	Not Found	Either there is no API method associated with the request URL path, or the request contains one or more parameters that did not return the data.
JSON Response	<pre>[{ "customerId": 0, "clientId": "string", "clientName": "string", "clientAddress": "string", "objectId": 0, "objectNumber": "string", "objectName": "string", "objectType": "string", "generatingCustomer": true, "objectAddress": "string", "agreementType": "string", "agreementModel": "string",</pre>		

"agreementFrom": 0,
"agreementTo": 0,
"generatingGroup": 0,
"generatingObjectPriorityGroup": 0,
"permissiblePowerConsumption": 0,
"permissiblePowerGeneration": 0,
"installedGeneratingPower": 0,
"installedConsumptionPower": 0,
"metersAmount": 0,
"autoMetersAmount": 0,
"reportingPeriod": "2020-09-02",
"billingPeriod": "2020-09-02",
"supplyState": "string",
"supplyStateFrom": "2020-09-02",
"supplyStateTo": "2020-09-02",
"metersNumber": "string",
"readingsSource": "string",
"readingsReceiveDate": "2020-09-02",
"paymentType": "string",
"declarationReferenceType": "string",
"service": "string",
"referenceSubmitDate": "2020-09-02",
"readingsSubmitDate": "2020-09-02",
"declarationReferenceNumber": 0,
"unaccountedConsumptionActNumber": 0,
"unaccountedConsumptionActCreateDate": "2020-09-02",
"unaccountedConsumptionActFrom": "2020-09-02",
"unaccountedConsumptionActTo": "2020-09-02",
"consumptionConversionActNumber": "string",
"consumptionConversionActCreateDate": "2020-09-02",
"consumptionConversionActFrom": "2020-09-02",
"consumptionConversionActTo": "2020-09-02",
"consumptionState": "string",
"consumptionStateFrom": "2020-09-02",
"consumptionStateTo": "2020-09-02",
"tariffPlan": "string",
"powerPlantCapacityDateFrom": "2020-09-02",
"energyObtainedDateFrom": "2020-09-02",
"powerPlantCapacityDateTo": "2020-09-02",
"powerPlantCapacitySource": "string",
"powerPlantCapacitySourceDateFrom": "2020-09-02",
"powerPlantCapacitySourceDateTo": "2020-09-02",

"energyObtainedDateTo": "2020-09-02",
"energyObtainedPowerKw": 0,
"tariffPlanChangeDate": "2020-09-02",
"consumptionConversionAct": true,
"unaccountedAct": true,
"conversionAct": true,
"operatorGridElectricityPercent": 0,
"clientGridElectricityPercent": 0,
"gaConsumptionAmount": 0,
"vkConsumptionAmount": 0,
"vkViapConsumptionAmount": 0,
"vkSppdConsumptionAmount": 0,
"vkDiscountConsumptionAmount": 0,
"ddConsumptionAmount": 0,
"ddViapConsumptionAmount": 0,
"ddSppdConsumptionAmount": 0,
"ddDiscountConsumptionAmount": 0,
"nkConsumptionAmount": 0,
"nkViapConsumptionAmount": 0,
"nkSppdConsumptionAmount": 0,
"nkDiscountConsumptionAmount": 0,
"maConsumptionAmount": 0,
"maViapConsumptionAmount": 0,
"vdConsumptionAmount": 0,
"vdViapConsumptionAmount": 0,
"svConsumptionAmount": 0,
"svViapConsumptionAmount": 0,
"miConsumptionAmount": 0,
"miViapConsumptionAmount": 0,
"rvConsumptionAmount": 0,
"rgConsumptionAmount": 0,
"vgConsumptionAmount": 0,
"reliability1ConsumptionAmount": 0,
"reliability2ConsumptionAmount": 0,
"reliability3ConsumptionAmount": 0,
"technologicalCostsViapConsumptionAmount": 0,
"technologicalCostsConsumptionAmount": 0,
"generalInterestConsumptionAmount": 0,
"vkConsumedElectricityConsumptionAmount": 0,
"ddConsumedElectricityConsumptionAmount": 0,
"nkConsumedElectricityConsumptionAmount": 0,
"maConsumedElectricityConsumptionAmount": 0,

"vdConsumedElectricityConsumptionAmount": 0,
"svConsumedElectricityConsumptionAmount": 0,
"miConsumedElectricityConsumptionAmount": 0,
"vkPayingRecoveredEnergyConsumptionAmount": 0,
"ddPayingRecoveredEnergyConsumptionAmount": 0,
"nkPayingRecoveredEnergyConsumptionAmount": 0,
"maPayingRecoveredEnergyConsumptionAmount": 0,
"vdPayingRecoveredEnergyConsumptionAmount": 0,
"svPayingRecoveredEnergyConsumptionAmount": 0,
"miPayingRecoveredEnergyConsumptionAmount": 0,
"vkPayingRecoveredPercentConsumptionAmount": 0,
"ddPayingRecoveredPercentConsumptionAmount": 0,
"nkPayingRecoveredPercentConsumptionAmount": 0,
"maPayingRecoveredPercentConsumptionAmount": 0,
"vdPayingRecoveredPercentConsumptionAmount": 0,
"svPayingRecoveredPercentConsumptionAmount": 0,
"miPayingRecoveredPercentConsumptionAmount": 0,
"vkPayingRecoveredPowerConsumptionAmount": 0,
"ddPayingRecoveredPowerConsumptionAmount": 0,
"nkPayingRecoveredPowerConsumptionAmount": 0,
"maPayingRecoveredPowerConsumptionAmount": 0,
"vdPayingRecoveredPowerConsumptionAmount": 0,
"svPayingRecoveredPowerConsumptionAmount": 0,
"miPayingRecoveredPowerConsumptionAmount": 0,
"vkPayingRecoveredMixedConsumptionAmount": 0,
"ddPayingRecoveredMixedConsumptionAmount": 0,
"nkPayingRecoveredMixedConsumptionAmount": 0,
"maPayingRecoveredMixedConsumptionAmount": 0,
"vdPayingRecoveredMixedConsumptionAmount": 0,
"svPayingRecoveredMixedConsumptionAmount": 0,
"miPayingRecoveredMixedConsumptionAmount": 0,
"vkMissingEnergyConsumptionAmount": 0,
"vkMissingEnergyViapConsumptionAmount": 0,
"vkMissingEnergySppdConsumptionAmount": 0,
"ddMissingEnergyConsumptionAmount": 0,
"ddMissingEnergyViapConsumptionAmount": 0,
"ddMissingEnergySppdConsumptionAmount": 0,
"nkMissingEnergyConsumptionAmount": 0,
"nkMissingEnergyViapConsumptionAmount": 0,
"nkMissingEnergySppdConsumptionAmount": 0,
"maMissingEnergyConsumptionAmount": 0,
"maMissingEnergyViapConsumptionAmount": 0,

"vdMissingEnergyConsumptionAmount": 0,
"vdMissingEnergyViapConsumptionAmount": 0,
"svMissingEnergyConsumptionAmount": 0,
"svMissingEnergyViapConsumptionAmount": 0,
"miMissingEnergyConsumptionAmount": 0,
"miMissingEnergyViapConsumptionAmount": 0,
"vkMissingEnergyDiscountConsumptionAmount": 0,
"ddMissingEnergyDiscountConsumptionAmount": 0,
"nkMissingEnergyDiscountConsumptionAmount": 0,
"gridSuppliedConsumptionAmount": 0,
"accumulatedBeginningConsumptionAmount": 0,
"accumulatedEndConsumptionAmount": 0,
"accumulatedUploadedConsumptionAmount": 0,
"accumulatedRaisedConsumptionAmount": 0,
"compensatedConsumptionAmount": 0,
"oldIndependentSupplier": "string",
"powerPlantCapacityConsumptionAmount": 0,
"energyObtainedConsumptionAmount": 0,
"operatorGridElectricityConsumptionAmount": 0,
"clientGridElectricityConsumptionAmount": 0,
"powerPlantCapacityUnit": "string",
"gaUnit": "string",
"vkUnit": "string",
"vkViapUnit": "string",
"vkSppdUnit": "string",
"vkDiscountUnit": "string",
"ddUnit": "string",
"ddViapUnit": "string",
"ddSppdUnit": "string",
"ddDiscountUnit": "string",
"nkUnit": "string",
"nkViapUnit": "string",
"nkSppdUnit": "string",
"nkDiscountUnit": "string",
"maUnit": "string",
"maViapUnit": "string",
"vdUnit": "string",
"vdViapUnit": "string",
"svUnit": "string",
"svViapUnit": "string",
"miUnit": "string",
"miViapUnit": "string",

"rvUnit": "string",
"rgUnit": "string",
"vgUnit": "string",
"reliability1Unit": "string",
"reliability2Unit": "string",
"reliability3Unit": "string",
"technologicalCostsViapUnit": "string",
"technologicalCostsUnit": "string",
"generalInterestUnit": "string",
"vkConsumedElectricityUnit": "string",
"ddConsumedElectricityUnit": "string",
"nkConsumedElectricityUnit": "string",
"maConsumedElectricityUnit": "string",
"vdConsumedElectricityUnit": "string",
"svConsumedElectricityUnit": "string",
"miConsumedElectricityUnit": "string",
"vkPayingRecoveredEnergyUnit": "string",
"ddPayingRecoveredEnergyUnit": "string",
"nkPayingRecoveredEnergyUnit": "string",
"maPayingRecoveredEnergyUnit": "string",
"vdPayingRecoveredEnergyUnit": "string",
"svPayingRecoveredEnergyUnit": "string",
"miPayingRecoveredEnergyUnit": "string",
"vkPayingRecoveredPercentUnit": "string",
"ddPayingRecoveredPercentUnit": "string",
"nkPayingRecoveredPercentUnit": "string",
"maPayingRecoveredPercentUnit": "string",
"vdPayingRecoveredPercentUnit": "string",
"svPayingRecoveredPercentUnit": "string",
"miPayingRecoveredPercentUnit": "string",
"vkPayingRecoveredPowerUnit": "string",
"ddPayingRecoveredPowerUnit": "string",
"nkPayingRecoveredPowerUnit": "string",
"maPayingRecoveredPowerUnit": "string",
"vdPayingRecoveredPowerUnit": "string",
"svPayingRecoveredPowerUnit": "string",
"miPayingRecoveredPowerUnit": "string",
"vkPayingRecoveredMixedUnit": "string",
"ddPayingRecoveredMixedUnit": "string",
"nkPayingRecoveredMixedUnit": "string",
"maPayingRecoveredMixedUnit": "string",
"vdPayingRecoveredMixedUnit": "string",

"svPayingRecoveredMixedUnit": "string",
"miPayingRecoveredMixedUnit": "string",
"vkMissingEnergyUnit": "string",
"vkMissingEnergyViapUnit": "string",
"vkMissingEnergySppdUnit": "string",
"ddMissingEnergyUnit": "string",
"ddMissingEnergyViapUnit": "string",
"ddMissingEnergySppdUnit": "string",
"nkMissingEnergyUnit": "string",
"nkMissingEnergyViapUnit": "string",
"nkMissingEnergySppdUnit": "string",
"maMissingEnergyUnit": "string",
"maMissingEnergyViapUnit": "string",
"vdMissingEnergyUnit": "string",
"vdMissingEnergyViapUnit": "string",
"svMissingEnergyUnit": "string",
"svMissingEnergyViapUnit": "string",
"miMissingEnergyUnit": "string",
"miMissingEnergyViapUnit": "string",
"vkMissingEnergyDiscountUnit": "string",
"ddMissingEnergyDiscountUnit": "string",
"nkMissingEnergyDiscountUnit": "string",
"vkReadingsFrom": 0,
"ddReadingsFrom": 0,
"nkReadingsFrom": 0,
"maReadingsFrom": 0,
"vdReadingsFrom": 0,
"svReadingsFrom": 0,
"miReadingsFrom": 0,
"rvReadingsFrom": 0,
"rgReadingsFrom": 0,
"vkConsumedElectricityReadingsFrom": 0,
"ddConsumedElectricityReadingsFrom": 0,
"nkConsumedElectricityReadingsFrom": 0,
"maConsumedElectricityReadingsFrom": 0,
"vdConsumedElectricityReadingsFrom": 0,
"svConsumedElectricityReadingsFrom": 0,
"miConsumedElectricityReadingsFrom": 0,
"gridSuppliedReadingsFrom": 0,
"vkReadingsTo": 0,
"ddReadingsTo": 0,
"nkReadingsTo": 0,

"maReadingsTo": 0,
"vdReadingsTo": 0,
"svReadingsTo": 0,
"miReadingsTo": 0,
"rvReadingsTo": 0,
"rgReadingsTo": 0,
"vkConsumedElectricityReadingsTo": 0,
"ddConsumedElectricityReadingsTo": 0,
"nkConsumedElectricityReadingsTo": 0,
"maConsumedElectricityReadingsTo": 0,
"vdConsumedElectricityReadingsTo": 0,
"svConsumedElectricityReadingsTo": 0,
"miConsumedElectricityReadingsTo": 0,
"gridSuppliedReadingsTo": 0,
"gaPriceEur": 0,
"vkPriceEur": 0,
"vkViapPriceEur": 0,
"vkSppdPriceEur": 0,
"vkDiscountPriceEur": 0,
"ddPriceEur": 0,
"ddViapPriceEur": 0,
"ddSppdPriceEur": 0,
"ddDiscountPriceEur": 0,
"nkPriceEur": 0,
"nkViapPriceEur": 0,
"nkSppdPriceEur": 0,
"nkDiscountPriceEur": 0,
"maPriceEur": 0,
"maViapPriceEur": 0,
"vdPriceEur": 0,
"vdViapPriceEur": 0,
"svPriceEur": 0,
"svViapPriceEur": 0,
"miPriceEur": 0,
"miViapPriceEur": 0,
"rvPriceEur": 0,
"rgPriceEur": 0,
"vgPriceEur": 0,
"reliability1PriceEur": 0,
"reliability2PriceEur": 0,
"reliability3PriceEur": 0,
"technologicalCostsViapPriceEur": 0,

"technologicalCostsPriceEur": 0,
"generalInterestPriceEur": 0,
"vkPayingRecoveredEnergyPriceEur": 0,
"ddPayingRecoveredEnergyPriceEur": 0,
"nkPayingRecoveredEnergyPriceEur": 0,
"maPayingRecoveredEnergyPriceEur": 0,
"vdPayingRecoveredEnergyPriceEur": 0,
"svPayingRecoveredEnergyPriceEur": 0,
"miPayingRecoveredEnergyPriceEur": 0,
"vkPayingRecoveredMixedPriceEur": 0,
"ddPayingRecoveredMixedPriceEur": 0,
"nkPayingRecoveredMixedPriceEur": 0,
"maPayingRecoveredMixedPriceEur": 0,
"vdPayingRecoveredMixedPriceEur": 0,
"svPayingRecoveredMixedPriceEur": 0,
"miPayingRecoveredMixedPriceEur": 0,
"vkMissingEnergyPriceEur": 0,
"vkMissingEnergyViapPriceEur": 0,
"vkMissingEnergySppdPriceEur": 0,
"ddMissingEnergyPriceEur": 0,
"ddMissingEnergyViapPriceEur": 0,
"ddMissingEnergySppdPriceEur": 0,
"nkMissingEnergyPriceEur": 0,
"nkMissingEnergyViapPriceEur": 0,
"nkMissingEnergySppdPriceEur": 0,
"maMissingEnergyPriceEur": 0,
"maMissingEnergyViapPriceEur": 0,
"vdMissingEnergyPriceEur": 0,
"vdMissingEnergyViapPriceEur": 0,
"svMissingEnergyPriceEur": 0,
"svMissingEnergyViapPriceEur": 0,
"miMissingEnergyPriceEur": 0,
"miMissingEnergyViapPriceEur": 0,
"vkMissingEnergyDiscountPriceEur": 0,
"ddMissingEnergyDiscountPriceEur": 0,
"nkMissingEnergyDiscountPriceEur": 0,
"powerPlantCapacityPriceEur": 0,
"gaDiscount": 0,
"vkDiscount": 0,
"vkViapDiscount": 0,
"vkSppdDiscount": 0,
"vkDiscountDiscount": 0,

"ddDiscount": 0,
"ddViapDiscount": 0,
"ddSppdDiscount": 0,
"ddDiscountDiscount": 0,
"nkDiscount": 0,
"nkViapDiscount": 0,
"nkSppdDiscount": 0,
"nkDiscountDiscount": 0,
"maDiscount": 0,
"maViapDiscount": 0,
"vdDiscount": 0,
"vdViapDiscount": 0,
"svDiscount": 0,
"svViapDiscount": 0,
"miDiscount": 0,
"miViapDiscount": 0,
"rvDiscount": 0,
"rgDiscount": 0,
"vgDiscount": 0,
"reliability1Discount": 0,
"reliability2Discount": 0,
"reliability3Discount": 0,
"technologicalCostsViapDiscount": 0,
"technologicalCostsDiscount": 0,
"generalInterestDiscount": 0,
"vkPayingRecoveredEnergyDiscount": 0,
"vkPayingRecoveredMixedDiscount": 0,
"vkMissingEnergyDiscount": 0,
"vkMissingEnergyViapDiscount": 0,
"vkMissingEnergySppdDiscount": 0,
"vkMissingEnergyDiscountDiscount": 0,
"gaAmountNoVAT": 0,
"vkAmountNoVAT": 0,
"vkViapAmountNoVAT": 0,
"vkSppdAmountNoVAT": 0,
"vkDiscountAmountNoVAT": 0,
"ddAmountNoVAT": 0,
"ddViapAmountNoVAT": 0,
"ddSppdAmountNoVAT": 0,
"ddDiscountAmountNoVAT": 0,
"nkAmountNoVAT": 0,
"nkViapAmountNoVAT": 0,

"nkSppdAmountNoVAT": 0,
"nkDiscountAmountNoVAT": 0,
"maAmountNoVAT": 0,
"maViapAmountNoVAT": 0,
"vdAmountNoVAT": 0,
"vdViapAmountNoVAT": 0,
"svAmountNoVAT": 0,
"svViapAmountNoVAT": 0,
"miAmountNoVAT": 0,
"miViapAmountNoVAT": 0,
"rvAmountNoVAT": 0,
"rgAmountNoVAT": 0,
"vgAmountNoVAT": 0,
"reliability1AmountNoVAT": 0,
"reliability2AmountNoVAT": 0,
"reliability3AmountNoVAT": 0,
"technologicalCostsViapAmountNoVAT": 0,
"technologicalCostsAmountNoVAT": 0,
"generalInterestAmountNoVAT": 0,
"vkPayingRecoveredEnergyAmountNoVAT": 0,
"ddPayingRecoveredEnergyAmountNoVAT": 0,
"nkPayingRecoveredEnergyAmountNoVAT": 0,
"maPayingRecoveredEnergyAmountNoVAT": 0,
"vdPayingRecoveredEnergyAmountNoVAT": 0,
"svPayingRecoveredEnergyAmountNoVAT": 0,
"miPayingRecoveredEnergyAmountNoVAT": 0,
"vkPayingRecoveredMixedAmountNoVAT": 0,
"ddPayingRecoveredMixedAmountNoVAT": 0,
"nkPayingRecoveredMixedAmountNoVAT": 0,
"maPayingRecoveredMixedAmountNoVAT": 0,
"vdPayingRecoveredMixedAmountNoVAT": 0,
"svPayingRecoveredMixedAmountNoVAT": 0,
"miPayingRecoveredMixedAmountNoVAT": 0,
"vkMissingEnergyAmountNoVAT": 0,
"vkMissingEnergyViapAmountNoVAT": 0,
"vkMissingEnergySppdAmountNoVAT": 0,
"ddMissingEnergyAmountNoVAT": 0,
"ddMissingEnergyViapAmountNoVAT": 0,
"ddMissingEnergySppdAmountNoVAT": 0,
"nkMissingEnergyAmountNoVAT": 0,
"nkMissingEnergyViapAmountNoVAT": 0,
"nkMissingEnergySppdAmountNoVAT": 0,

	<pre>"maMissingEnergyAmountNoVAT": 0, "maMissingEnergyViapAmountNoVAT": 0, "vdMissingEnergyAmountNoVAT": 0, "vdMissingEnergyViapAmountNoVAT": 0, "svMissingEnergyAmountNoVAT": 0, "svMissingEnergyViapAmountNoVAT": 0, "miMissingEnergyAmountNoVAT": 0, "miMissingEnergyViapAmountNoVAT": 0, "vkMissingEnergyDiscountAmountNoVAT": 0, "ddMissingEnergyDiscountAmountNoVAT": 0, "nkMissingEnergyDiscountAmountNoVAT": 0, "powerPlantCapacityAmountNoVAT": 0, "permanentHomePlusAmountNoVAT": 0, "permanentHomeAmountNoVAT": 0 }]</pre>				
JSON error response	<pre>{ "errorMessages": [{ "code": 0, "text": "string" }] }</pre>				
Rules	No.	Rule description	Error code	Error message	Attribute
	1.	The order status must be Completed.	2010	Invalid report order status.	orderId
	2.	According to the submitted order number: [orderId], the order does not exist.	2016	Report order doesn't exist in the system.	orderId
	3.	Invalid method selected or parameter specified incorrectly. According to the submitted order number: [orderId] report type is: [orderType]	2017	Invalid method selected for report data or incorrect parameter.	orderId orderType
	4.	No data found based on the search parameters submitted in the POST method.	2018	There is no data for the selected search parameters, the response is empty.	orderId

	5.	The number of objects in the return list must be less than or equal to 10000.	2022	The number of objects on the list has been exceeded.	count
--	----	---	------	--	-------

7.3.10.1 JSON Response structure

The table below describes the structure of the JSON response:

Attribute	type	obligation	description
-	-	-	Response description are provided in https://datahub.eso.lt/dokumentacija . In next document version, all fields description will be provided here.

7.3.10.2 Error Response Structure

The following table describes the JSON structure in the event of a response error:

No.	Attribute	type	obligation	description
1.	code	number	required	Error code.
2.	text	string(4000)	required	Error message.

7.3.11 GET/gateway/order/{orderId}/count

URL	GET/gateway/order/{orderId}/count
Description	Method which will return count (number), how many items Supplier will get in ordered report (reports could have more than 1 item, so it is List). It should be used when supplier need to split data in few portions. This response should be used in reports' GET methods request, where Supplier can provide method parameters information.
Parameters	<p>URL parameters:</p> <ul style="list-style-type: none"> orderId – order identification number. Required.
Header	After decrypting the supplier authentication key, the supplier ID is used to select the data.
JSON request	GET request does not have the BODY part.

Response	HTTP status code	Reason	Response description		
	200	OK	Request completed successfully.		
	204	No content	No data found according to the given parameters.		
	400	Bad Request	Request error. The HTTP response body provides a list of errors in JSON format.		
	401	Unauthorized	An attempt was made to connect to a non-public method that requires authentication, but no user credentials were provided.		
	403	Forbidden	According to the access control policy, the current user does not have access to perform the requested action.		
	404	Not Found	Either there is no API method associated with the request URL path, or the request contains one or more parameters that did not return the data.		
	423	Locked	The source or destination resource of a method is locked. This response SHOULD contain an appropriate precondition or postcondition code, such as 'lock-token-submitted' or 'no-conflicting-lock'.		
JSON Response	<pre>{ "count": "number" }</pre>				
JSON error response	<pre>{ "errorMessages": [{ "code": 0, "text": "string" }] }</pre>				
Rules	No.	Rule description	Error code	Error message	Attribute
	1.	The order status must be Completed.	2010	Invalid report order status.	orderId

	2.	According to the submitted order number: [orderId], the order does not exist.	2016	Report order doesn't exist in the system.	orderId
	3.	Invalid method selected or parameter specified incorrectly. According to the submitted order number: [orderId] report type is: [orderType]	2017	Invalid method selected for report data or incorrect parameter.	orderId orderType
	4.	No data found based on the search parameters submitted in the POST method.	2018	There is no data for the selected search parameters, the response is empty.	orderId

7.3.11.1 JSON Request structure

The table below describes the structure of the JSON request:

Attribute	type	obligation	description

7.3.11.2 JSON Response structure

The table below describes the structure of the JSON response:

No.	Attribute	type	obligation	description
1.	count	Number(10)	required	Number of rows, objects, accounts, depending on the selected report.

7.3.11.3 Error Response Structure

The following table describes the JSON structure in the event of a response error:

No.	Attribute	type	obligation	description
1.	code	number	required	Error code.
2.	text	string(4000)	required	Error message.

7.3.12 POST/gateway/order/v2/data-hr-15min-mtr-lvl-acr

URL	POST/gateway/order/v2/data-hr-15min-mtr-lvl-acr		
Description	The method is designed for ordering data for automated quantities at the counter level according to the rights granted.		
Parameters	<p>URL parameters:</p> <p>The JSON data is contained in the HTTP request (BODY) (<i>see JSON structure, below</i>).</p>		
Header	After decrypting the supplier authentication key, the supplier ID is used to select the data.		
JSON request	<pre>{ "dateFrom": "date", "dateTo": "date", "consumptionCategories":[string, string], "objectNumbers":[string, string], "interval":"string" }</pre>		
Response HTTP code	HTTP status code	Reason	Description
	201	Created	The request has been successfully completed.
	400	Bad Request	Request error. The HTTP response body provides a list of errors in JSON format. (<i>Error response of the JSON structure below</i>).
	401	Unauthorized	An attempt was made to connect to a non-public method that requires authentication, but no user credentials were provided.
	403	Forbidden	According to the access control policy, the current user does not have access to perform the requested action.

	404	Not Found	Either there is no API method associated with the request URL path, or the request contains one or more parameters that did not return the data.		
JSON response	<pre>{ "orderId": "number" }</pre>				
JSON error response	<pre>{ "errorMessages": [{ "code": "integer", "text": "string" }] }</pre>				
Rules	No.	Rule description	Error code	Error message	Attributes
	1.	If an attribute has defined possible values, the value index can be specified by specifying the value of the attribute in the request. Indices of all possible values start from 0.	-	-	All attributes with specified values.
	2.	Date format is incorrect.	-	-	dateFrom dateTo
	3.	The date from cannot be later than the date to. Equal can be.	1002	Date from cannot be later than date to.	dateFrom, dateTo
	4.	The date from and date to cannot be later than the current date but can be equal.	1008	Date from and date to cannot be later than the current date.	dateFrom
	5.	Object meter must be automated.	2007	The submitted object number: [objectNumber (if there is more than one object, objects must be separated by the semicolon)], was not found or the meter of object is not automated.	objectNumbers
	6.	Data cannot be older than 36 months old.	2012	Date from cannot be older than 36 months old.	dateFrom

	7.	Report can be ordered maximum for 12 months.	2013	The report can only be ordered for 12 months or less.	dateFrom dateTo
	8.	The period date from and date to must be less than date from configurable parameter.	2015	Data is not currently available for the selected reporting period.	dateFrom dateTo
	9.	The object must have a valid access right.	2020	Object [objectNumber (if there is more than one object, objects must be separated by the semicolon)] does not have a access right or access right is expired.	objectNumbers
	10.	A maximum of 500 objects can be submitted in a report order	2021	A maximum of 500 objects can be submitted in a report order	objectNumbers
	11.	If objectNumbers[null] , then the report can be ordered for a maximum of 1 month period.	2023	The report without specifying the objects can only be ordered for 1 month or less.	objectNumbers dateFrom dateTo

7.3.12.1 JSON Request structure

The table below describes the structure of the JSON request:

No.	Attribute	type	obligation	description
1.	dateFrom	Date	required	The beginning of the reporting period: <ul style="list-style-type: none"> The format: YYYY-MM-DD; The reporting period start date is the first day of the month.
2.	dateTo	Date	required	The end of the reporting period: <ul style="list-style-type: none"> The format: YYYY-MM-DD; The reporting period end date is the last day of the month.
3.	consumptionCategory	String(20)	required	The consumption category. Possible meanings: <ul style="list-style-type: none"> P+; P-; Q+; Q-;

4.	objectNumbers	String	required	Object number.
5.	interval	String	required	Consumption interval. Possible meanings: - HOUR - QUARTER

7.3.12.2 JSON Response structure

The table below describes the structure of the JSON response:

No.	Attribute	type	obligation	description
1.	orderId	Integer	required	The report ordering primary surrogate key.

7.3.12.3 Error Response Structure

The following table describes the JSON structure in the event of a response error:

No.	Attribute	type	obligation	description
1.	code	number	required	Error code.
2.	text	string(4000)	required	Error message.

7.3.13 POST/gateway/order/v2/data-hr-15min-obj-lvl-acr

URI	POST/gateway/order/v2/data-hr-15min-obj-lvl-acr
Description	The method is designed for ordering data for automated quantities at the object level according to the rights granted.
Parameters	<p>URL parameters:</p> <p>The JSON data is contained in the HTTP request (BODY) (<i>see JSON structure, below</i>).</p>

Header	After decrypting the supplier authentication key, the supplier ID is used to select the data.		
JSON request	<pre>{ "dateFrom": "date", "dateTo": "date", "consumptionCategories": ["string", "string"], "objectNumbers": ["string", "string"], "interval": "string", "netBilling": { "intervalData": "boolean", "intervalDataDetailed": "boolean" } }</pre>		
Response HTTP code	HTTP status code	Reason	Description
	201	Created	The request has been successfully completed.
	400	Bad Request	Request error. The HTTP response body provides a list of errors in JSON format. (<i>Error response of the JSON structure below</i>).
	401	Unauthorized	An attempt was made to connect to a non-public method that requires authentication, but no user credentials were provided.
	403	Forbidden	According to the access control policy, the current user does not have access to perform the requested action.
	404	Not Found	Either there is no API method associated with the request URL path, or the request contains one or more parameters that did not return the data.
JSON response	<pre>{ "orderId": "number" }</pre>		

	}				
JSON error response	<pre>{ "errorMessages": [{ "code": 0, "text": "string" }] }</pre>				
Rules	No.	Rule description	Error code	Error message	Attributes
	1.	If an attribute has defined possible values, the value index can be specified by specifying the value of the attribute in the request. Indices of all possible values start from 0.	-	-	All attributes with specified values.
	2.	Date format is incorrect.	-	-	dateFrom dateTo
	3.	The date from cannot be later than the date to. Equal can be.	1002	Date from cannot be later than date to.	dateFrom, dateTo
	4.	The date from and date to cannot be later than the current date but can be equal.	1008	Date from and date to cannot be later than the current date.	dateFrom
	5.	Object meter must be automated.	2007	The submitted object number: [objectNumber (if there is more than one object, objects must be separated by the semicolon)], was not found or the meter of object is not automated.	objectNumbers
	6.	Data cannot be older than 36 months old.	2012	Date from cannot be older than 36 months old.	dateFrom
	7.	Report can be ordered maximum for 12 months.	2013	The report can only be ordered for 12 months or less.	dateFrom dateTo

8.	The period date from and date to must be less than date from configurable parameter.	2015	Data is not currently available for the selected reporting period.	dateFrom dateTo
9.	The object must have a valid access right.	2020	Object [objectNumber (if there is more than one object, objects must be separated by the semicolon)] does not have a access right or access right is expired.	objectNumbers
10.	A maximum of 500 objects can be submitted in a report order	2021	A maximum of 500 objects can be submitted in a report order	objectNumbers
11.	If objectNumbers[null] , then the report can be ordered for a maximum of 1 month period.	2023	The report without specifying the objects can only be ordered for 1 month or less.	objectNumbers dateFrom dateTo
12.	The meaning of the [ObjectNumber] cannot be repeated.	2028	The object: [objectNumber (if there is more than one object, objects must be separated by the semicolon)] is repeating.	objectNumber
13.	Parameter below can only be specified, if netBilling intervalData=TRUE : <ul style="list-style-type: none"> intervalDataDetailed Note: Without specifying parameter, i.e. specifying NULL will treat as FALSE.	2029	An option to choose the type of power plant data view is only possible if the order is submitted for the object, which has "Net billing" accounting scheme.	netBilling, intervalData, intervalDataDetailed

7.3.13.1 JSON Request structure

The table below describes the structure of the JSON request:

No.	Attribute	Type	Obligation	Description
1.	dateFrom	Date	required	The beginning of the reporting period: <ul style="list-style-type: none"> The format: YYYY-MM-DD; The reporting period start date is the first day of the month.
2.	dateTo	Date	required	The end of the reporting period: <ul style="list-style-type: none"> The format: YYYY-MM-DD; The reporting period end date is the last day of the month.
3.	consumptionCategory	String(20)	required	The consumption category. Possible meanings: <ul style="list-style-type: none"> P+; P-; Q+; Q-;
4.	objectNumbers	String	required	Object number.
5.	interval	String	required	Consumption interval. Possible meanings: <ul style="list-style-type: none"> HOURL QUARTER
6.	netBilling: {}			
6.1	intervalData	Boolean	not required	Indication that the object is in "Net billing" accounting scheme. Possible meanings: <ul style="list-style-type: none"> TRUE FALSE NULL Default value is NULL. NULL is treated as False.
6.2	intervalDataDetailed	Boolean	not required	Indication of whether object in "Net billing" accounting scheme detailed information should be retrieved. Possible meanings: <ul style="list-style-type: none"> TRUE – a detailed view will be returned (the consumption object and all its power plant objects); FALSE – a aggregated view will be returned (the consumption object without power plant objects); NULL. Default value is NULL. NULL is treated as False.

7.3.13.2 JSON Response structure

The table below describes the structure of the JSON response:

No.	Attribute	type	obligation	description
1.	orderId	Integer	required	The report ordering primary surrogate key.

7.3.13.3 Error Response Structure

The following table describes the JSON structure in the event of a response error:

No.	Attribute	type	obligation	description
1.	code	number	required	Error code.
2.	text	string(4000)	required	Error message.

7.3.14 POST/gateway/order/data-sum-obj-lvl-acr

URL	POST/gateway/order/data-sum-obj-lvl-acr
Description	The method is for order a report of total quantities according to the granted rights.
Parameters	<p>URL parameters:</p> <p>The JSON data is contained in the HTTP request (BODY) (<i>see JSON structure, below</i>).</p>
Header	After decrypting the supplier authentication key, the supplier ID is used to select the data.
JSON request	<pre>{ "dateFrom": "date", "dateTo": "date", "objectNumbers": ["string"] }</pre>

Response HTTP code	HTTP status code	Reason	Description		
	201	Created	The request has been successfully completed.		
	400	Bad Request	Request error. The HTTP response body provides a list of errors in JSON format. (<i>Error response of the JSON structure below</i>).		
	401	Unauthorized	An attempt was made to connect to a non-public method that requires authentication, but no user credentials were provided.		
	403	Forbidden	According to the access control policy, the current user does not have access to perform the requested action.		
	404	Not Found	Either there is no API method associated with the request URL path, or the request contains one or more parameters that did not return the data.		
JSON response	<pre>{ "orderId": "integer" }</pre>				
JSON error response	<pre>{ "errorMessages": [{ "code": "integer", "text": "string" }] }</pre>				
Rules	No.	Rule description	Error code	Error message	Attributes
	1.	Date format is incorrect.	-	-	dateFrom dateTo
	2.	The date from cannot be later than the date to. Equal can be.	1002	Date from cannot be later than date to.	dateFrom, dateTo
	3.	Data cannot be older than 36 months old.	2012	Date from cannot be older than 36 months old.	dateFrom

5.	The period date from and date to must be less than date from configurable parameter.	2015	Data is not currently available for the selected reporting period.	dateFrom dateTo
6.	The object must have a valid access right.	2020	Object [objectNumbers (if there is more than one object, objects must be separated by the semicolon)] does not have a access right or access right is expired.	objectNumbers
7.	A maximum of 500 objects can be submitted in a report order.	2021	A maximum of 500 objects can be submitted in a report order.	objectNumbers
8.	The date from and date to cannot be later than the current date, but can be equal.	1008	Date from and date to cannot be later than the current date.	dateFrom dateTo
9.	dateFrom - must be the first day of the month; dateTo - must be the last day of the month, unless dateTo coincides with the current month, then must be currentDate	2009	Date from must be the first day of the month. Date to must be the last day of the month, unless date to coincides with the current day.	dateFrom dateTo

7.3.14.1 JSON Request structure

The table below describes the structure of the JSON request:

No.	Attribute	type	obligation	description
1.	dateFrom	Date	required	The beginning of the reporting period: <ul style="list-style-type: none"> The format: YYYY-MM-DD; The reporting period start date is the first day of the month.
2.	dateTo	Date	required	The end of the reporting period: <ul style="list-style-type: none"> The format: YYYY-MM-DD; The reporting period end date is the last day of the month.
4.	objectNumbers	String	required	Object numbers.

7.3.14.2 JSON Response structure

The table below describes the structure of the JSON response:

No.	Attribute	type	obligation	description
1.	orderId	Integer	required	The report ordering primary surrogate key.

7.3.14.3 Error Response Structure

The following table describes the JSON structure in the event of a response error:

No.	Attribute	type	obligation	description
1.	code	number	required	Error code.
2.	text	string(4000)	required	Error message.

7.3.15 POST/gateway/order/v2/report-obj-acr

URL	POST /gateway/order/v2/report-obj-acr		
Description	The method is for order a report of objects according to the granted rights.		
Parameters	URL: The JSON data is contained in the HTTP request (BODY) (<i>see JSON structure, below</i>).		
Header	After decrypting the supplier authentication key, the supplier ID is used to select the data.		
JSON request	<pre>{ "objectNumbers":["string"] }</pre>		
Response HTTP code	HTTP status code	Reason	Description
	201	Created	The request has been successfully completed.
	400	Bad Request	Request error. The HTTP response body provides a list of errors in JSON format. (<i>Error response of the JSON structure below</i>).

	401	Unauthorized	An attempt was made to connect to a non-public method that requires authentication, but no user credentials were provided.		
	403	Forbidden	According to the access control policy, the current user does not have access to perform the requested action.		
	404	Not Found	Either there is no API method associated with the request URL path, or the request contains one or more parameters that did not return the data.		
JSON response	<pre>{ "orderId": "number" }</pre>				
JSON error response	<pre>{ "errorMessages": [{ "code": 0, "text": "string" }] }</pre>				
Rules	No.	Rule description	Error code	Error message	Attributes
	1.	The object must have a valid access right.	2020	Object [objectNumbers (if there is more than one object, objects must be separated by the semicolon)] does not have a access right or access right is expired.	objectNumbers
	2.	A maximum of 500 objects can be submitted in a report order.	2021	A maximum of 500 objects can be submitted in a report order.	objectNumbers

7.3.15.1 JSON Request structure

The table below describes the structure of the JSON request:

No.	Attribute	type	obligation	description
1.	objectNumbers	String	required	Object numbers.

7.3.15.2 JSON Response structure

The table below describes the structure of the JSON response:

No.	Attribute	type	obligation	description
1.	orderId	Integer	required	The report ordering primary surrogate key.

7.3.15.3 Error Response Structure

The following table describes the JSON structure in the event of a response error:

No.	Attribute	type	obligation	description
1.	code	number	required	Error code.
2.	text	string(4000)	required	Error message.

7.3.16 GET /gateway/order/{orderId}/data-hr-15min-obj-lvl-acr

URL	GET /gateway/order/{orderId}/data-hr-15min-obj-lvl-acr
Description	The method for receive the order report "Automated quantities at the object level according to the granted rights".
Parameters	<p>URL parameters:</p> <ul style="list-style-type: none"> • orderId – order identification number • first - the index of the object, which must be the first in the return list (starting from 0). Optional. The default value is 0. • count - the number of objects in the return list. Optional. The default value is 10000. If no count value is given, the default value count will be 10000.
Header	After decrypting the supplier authentication key, the supplier ID is used to select the data.
JSON request	

Response HTTP code	HTTP status code	Reason	Description
	200	OK	Request completed successfully.
	204	No content	No data found according to the given parameters.
	400	Bad Request	Request error. The HTTP response body provides a list of errors in JSON format. (<i>Error response of the JSON structure below</i>).
	401	Unauthorized	An attempt was made to connect to a non-public method that requires authentication, but no user credentials were provided.
	403	Forbidden	According to the access control policy, the current user does not have access to perform the requested action.
	404	Not Found	Either there is no API method associated with the request URL path, or the request contains one or more parameters that did not return the data.
JSON response	<pre> { "personCode": "string", "personName": "string", "personSurname": "string", "objectId": "integer", "objectNumber": "string", "graphVersion": "dateTime", "consumptionCategories": [{ "consumptionCategory": "string", "powerPlantObjectNumber": "string", "powerPlantType": "string", "consumptions": [{ "consumptionTime": "datetime", "amount": "integer", "valueType": "string", </pre>		

	<pre> "usageType": "string" }] } } </pre>				
JSON error response	<pre> { "errorMessages": [{ "code": 0, "text": "string" }] } </pre>				
Rules	No.	Rule description	Error code	Error message	Attributes
	1.	The order status must be Completed.	2010	Invalid report order status.	orderId
	2.	According to the submitted order number: [orderId], the order does not exist.	2016	Report order doesn't exist in the system.	orderId
	3.	Invalid method selected or parameter specified incorrectly. According to the submitted order number: [orderId] report type is: [orderType]	2017	Invalid method selected for report data or incorrect parameter.	orderId orderType
	4.	No data found based on the search parameters submitted in the POST method.	2018	There is no data for the selected search parameters, the response is empty.	orderId
	5.	The number of objects in the return list must be less than or equal to 10000.	2022	The number of objects on the list has been exceeded.	count

7.3.16.1 JSON Request structure

The table below describes the structure of the JSON request:

No.	Attribute	Type	Obligation	Description

7.3.16.2 JSON Response structure

The table below describes the structure of the JSON response:

No.	Attribute	Type	Obligation	Description
1.	personCode	String(20)	required	Person code.
2.	personName	String(200)	required	Person name / company name.
3.	personSurname	String(50)	required	Person surname.
4.	objectId	Integer	required	Object ID.
5.	objectNumber	String(20)	required	Object number.
6.	graphVersion	DateTime	not required	Calculated version of the "Net billing" accounting scheme graph. Note: Filled in if attributes were selected when ordering the report: intervalData: true .
7.	consumtionCategories: []			
7.1	consumptionCategory	String(2)	required	Consumption category. Possible meanings: <ul style="list-style-type: none"> • P+; • P-; • Q+; • Q-.
7.2	powerPlantObjectNumber	String(20)	not required	Power plant object number, which has "Net billing" accounting scheme. Note:

				Filled in if attributes were selected when ordering the report: intervalData: true AND intervalDataDetailed: true .
7.3	powerPlantType	String(2)	not required	Type of the power plant. Possible meanings: <ul style="list-style-type: none"> • A – Waste; • B – Biomass; • H – Hydroelectric; • K – Other; • S – Solar; • T – TEC; • V – Wind. <p>Note:</p> <p>Filled in if attributes were selected when ordering the report: intervalData: true AND intervalDataDetailed: true.</p>
8.	consumptions: []			
8.1	consumptionTime	datetime	required	Consumption time. Example of consumptionTime format: 2022-06-07T00:00:00+02:00 2022-06-07T00:00:00+03:00
8.2	amount	number	required	Consumption amount.
8.3	valueType	String(3)	required	Consumption value type. Possible meanings: <ul style="list-style-type: none"> • EST – estimated; • VAL – validated.
8.4	usageType	String(1)	not required	Reading usage type (only for object, which has "Net billing" accounting scheme). Possible field values are: <ul style="list-style-type: none"> • B – Billing; • D – Daily <p>Note:</p> <p>Filled in if attributes were selected when ordering the report: intervalData: true.</p>

7.3.16.3 Error Response Structure

The following table describes the JSON structure in the event of a response error:

No.	Attribute	type	obligation	description
1.	code	number	required	Error code.
2.	text	string(4000)	required	Error message.

7.3.17 GET /gateway/order/{orderId}/data-hr-15min-mtr-lvl-acr

URL	GET /gateway/order/{orderId}/data-hr-15min-mtr-lvl-acr		
Description	The method for receive the order report " Automated quantities at the meter level based on granted rights".		
Parameters	<p>URL parameters:</p> <ul style="list-style-type: none"> • orderId – order identification number • first - the index of the object, which must be the first in the return list (starting from 0). Optional. The default value is 0. • count - the number of objects in the return list. Optional. The default value is 10000. If no count value is given, the default value count will be 10000. 		
Header	After decrypting the supplier authentication key, the supplier ID is used to select the data.		
JSON request			
Response HTTP code	HTTP status code	Reason	Description
	200	OK	Request completed successfully.
	204	No content	No data found according to the given parameters.
	400	Bad Request	Request error. The HTTP response body provides a list of errors in JSON format. (<i>Error response of the JSON structure below</i>).

	401	Unauthorized	An attempt was made to connect to a non-public method that requires authentication, but no user credentials were provided.
	403	Forbidden	According to the access control policy, the current user does not have access to perform the requested action.
	404	Not Found	Either there is no API method associated with the request URL path, or the request contains one or more parameters that did not return the data.

JSON response	<pre>[{ "personCode": "string", "personName": "string", "personSurname": "string", "objectId": number, "objectNumber": "string", "meters": [{ "meterNumber": "string", "categories": [{ "consumptionCategory": "string", "consumptions": [{ "consumptionTime": "datetime", "amount": number, "valueType": "string" }] }] }] }]</pre>		
----------------------	--	--	--

JSON error response	<pre> { "errorMessages": [{ "code": 0, "text": "string" }] } </pre>				
Rules	No.	Rule description	Error code	Error message	Attributes
	1.	The order status must be Completed.	2010	Invalid report order status.	orderId
	2.	According to the submitted order number: [orderId], the order does not exist.	2016	Report order doesn't exist in the system.	orderId
	3.	Invalid method selected or parameter specified incorrectly. According to the submitted order number: [orderId] report type is: [orderType]	2017	Invalid method selected for report data or incorrect parameter.	orderId orderType
	4.	No data found based on the search parameters submitted in the POST method.	2018	There is no data for the selected search parameters, the response is empty.	orderId
	5.	The number of objects in the return list must be less than or equal to 10000.	2022	The number of objects on the list has been exceeded.	count

7.3.17.1 JSON Request structure

The table below describes the structure of the JSON request:

No.	Attribute	type	obligation	description

7.3.17.2 JSON Response structure

The table below describes the structure of the JSON response:

No.	Attribute	type	obligation	description
1.	personCode	String(20)	required	Person code.
2.	personName	String(200)	required	Person name / company name.
3.	personSurname	String(50)	required	Person surname.
4.	objectId	Integer	required	Object ID.
5.	objectNumber	String(20)	required	Object number.
6.	meters: []			
6.1	meterNumber	String(20)	required	Meter number of the object.
7.	categories: []			
7.1	consumptionCategory	String(2)	required	Consumption category. Possible meanings: <ul style="list-style-type: none"> • P+; • P-; • Q+; • Q-.
	consumptions: []			
8.	consumptionTime	Datetime	required	Consumption time. Example of consumptionTime format: 2022-06-07T00:00:00+02:00 2022-06-07T00:00:00+03:00
9.	amount	Number	required	Consumption amount.
10.	valueType	String(3)	required	Consumption value type. Possible meanings: <ul style="list-style-type: none"> • EST – estimated; • VAL – validated.

7.3.17.3 Error Response Structure

The following table describes the JSON structure in the event of a response error:

No.	Attribute	type	obligation	description
1.	code	number	required	Error code.
2.	text	string(4000)	required	Error message.

7.3.18 GET /gateway/order/v2/{orderId}/report-obj-acr

URL	GET /gateway/order/v2/{orderId}/report-obj-acr?first={integer}&count={integer}		
Description	The method for used to the order report "Report of objects by granted rights".		
Parameters	<p>URL parameters:</p> <ul style="list-style-type: none"> • orderId – order identification number • first - the index of the object, which must be the first in the return list (starting from 0). Optional. The default value is 0. • count - the number of objects in the return list. Optional. The default value is 10000. If no count value is given, the default value count will be 10000. 		
Header	After decrypting the supplier authentication key, the supplier ID is used to select the data.		
JSON request			
Response HTTP code	HTTP status code	Reason	Description
	200	OK	Request completed successfully.
	204	No content	No data found according to the given parameters.
	400	Bad Request	Request error. The HTTP response body provides a list of errors in JSON format. (<i>Error response of the JSON structure below</i>).

	401	Unauthorized	An attempt was made to connect to a non-public method that requires authentication, but no user credentials were provided.
	403	Forbidden	According to the access control policy, the current user does not have access to perform the requested action.
	404	Not Found	Either there is no API method associated with the request URL path, or the request contains one or more parameters that did not return the data.

JSON response	<pre>[{ "consumerCode":"string", "personCode":"string", "personName":"string", "personSurname":"string", "objectId":"number", "objectNumber":"string", "objectName":"string", "objectType":"string", "objectAddress":"string", "contractType":"string", "contractModel":"string", "permissiblePowerConsumption":"number", "permissiblePowerGeneration":"number", "metersAmount":"number", "autoMetersAmount":"number", "smartMeterInstallationDate":"date", "supplyState":"string", "supplyStateFrom":"date", "supplyStateTo":"date", "consumptionState":"string", "consumptionStateFrom":"date", "consumptionStateTo":"date", "productsAmount":"number", "scalesAmount":"number", "technologicalCosts":"boolean", "payoffMethod":"string", "payoffMethodChangeDate":"date", "generatingObjectType":"string", "generatingObjectTypeFrom":"date",</pre>		
----------------------	---	--	--

	<pre> "generatingObjectTypeTo": "date", "powerPlantObjects": [{ "powerPlantObjectNumber": "string", "powerPlantType": "string" }], "generatingObjectPower": "double", "voltage": "number", "tariffPlan": "string", "tariffPlanChangeDate": "date", "timeZone": "string", "consumptionAverage": "double", "consumptionAverageCalculationDate": "datetime", "consumptionAverageCalculationMonthsCount": "integer" }] </pre>				
JSON error response	<pre> { "errorMessages": [{ "code": 0, "text": "string" }] } </pre>				
Rules	No.	Rule description	Error code	Error message	Attributes
	1.	The order status must be Completed.	2010	Invalid report order status.	orderId
	2.	According to the submitted order number: [orderId], the order does not exist.	2016	Report order doesn't exist in the system.	orderId
	3.	Invalid method selected or parameter specified incorrectly. According to the submitted order number: [orderId] report type is: [orderType]	2017	Invalid method selected for report data or incorrect parameter.	orderId orderType

	4.	No data found based on the search parameters submitted in the POST method.	2018	There is no data for the selected search parameters, the response is empty.	orderId
--	----	--	------	---	---------

7.3.18.1 JSON Request structure

The table below describes the structure of the JSON request:

No.	Attribute	type	obligation	description

7.3.18.2 JSON Response structure

The table below describes the structure of the JSON response:

No.	Attribute	type	obligation	description
1.	-	-	-	Response description are provided in https://datahub.eso.lt/dokumentacija . In next document version, all fields description will be provided here.

7.3.18.3 Error Response Structure

The following table describes the JSON structure in the event of a response error:

No.	Attribute	type	obligation	description
1.	code	number	required	Error code.
2.	text	string(4000)	required	Error message.

7.3.19 GET /gateway/order/{orderId}/data-sum-obj-lvl-acr

URL	GET /gateway/order/{orderId}/data-sum-obj-lvl-acr?first={integer}&count={integer}		
Description	The method is used to obtain the requested "Aggregate quantities by entitlement" report.		
Parameters	<p>URL parameters:</p> <ul style="list-style-type: none"> • orderId – order identification number • first - the index of the object, which must be the first in the return list (starting from 0). Optional. The default value is 0. • count - the number of objects in the return list. Optional. The default value is 10000. If no count value is given, the default value count will be 10000. 		
Header	After decrypting the supplier authentication key, the supplier ID is used to select the data.		
JSON request			
Response HTTP code	HTTP status code	Reason	Description
	200	OK	Request completed successfully.
	204	No content	No data found according to the given parameters.
	400	Bad Request	Request error. The HTTP response body provides a list of errors in JSON format. (<i>Error response of the JSON structure below</i>).
	401	Unauthorized	An attempt was made to connect to a non-public method that requires authentication, but no user credentials were provided.
	403	Forbidden	According to the access control policy, the current user does not have access to perform the requested action.
	404	Not Found	Either there is no API method associated with the request URL path, or the request contains one or more parameters that did not return the data.
JSON response	<pre>[{ "personCode": "string", "personName": "string",</pre>		

```
"personSurname": "string",
"objectId": "number",
"objectNumber": "string",
"products": [
  {
    "productCode": "string",
    "productName": "string",
    "productType": "string",
    "unit": "string",
    "consumptionCategories": [
      {
        "category": "string",
        "consumptions": [
          {
            "billingPeriod": "date",
            "consumptionAmount": "number",
            "productConsumptionType": "string"
          }
        ]
      }
    ]
  }
]
```

JSON error response

```
{
  "errorMessages": [
    {
      "code": 0,
      "text": "string"
    }
  ]
}
```

Rules	No.	Rule description	Error code	Error message	Attributes
	1.	The order status must be Completed.	2010	Invalid report order status.	orderId
	2.	According to the submitted order number: [orderId], the order does not exist.	2016	Report order doesn't exist in the system.	orderId
	3.	Invalid method selected or parameter specified incorrectly. According to the submitted order number: [orderId] report type is: [orderType]	2017	Invalid method selected for report data or incorrect parameter.	orderId orderType
	4.	No data found based on the search parameters submitted in the POST method.	2018	There is no data for the selected search parameters, the response is empty.	orderId

7.3.19.1 JSON Request structure

The table below describes the structure of the JSON request:

No.	Attribute	type	obligation	description

7.3.19.2 JSON Response structure

The table below describes the structure of the JSON response:

No.	Attribute	type	obligation	description
1.	personCode	String(20)	required	Person code.
2.	personName	String(20)	required	Person name.
3.	personSurname	String(50)	not required	Person surname.
4.	objectId	number	required	Object ID.
5.	objectNumber	String	required	Object number.

products: []

6.	productCode	String(20)	not required	Product code.
7.	productName	String(4000)	not required	Product name.
8.	productType	String(5)	not required	Product type.
9.	unit	String(255)	not required	The unit of the product.
consumptionCategories: []				
10.	category	String(2)	required	Consumption category.
consumptions: []				
11.	billingPeriod	Datetime	required	Month in which electricity consumption is recorded.
12.	consumptionAmount	number	required	The amount of the consumption
13.	productConsumptionType	String(20)	not required	Type of the product consumption. Possible meanings: - AMS - Abonentinis mok. (Subscription fee)

7.3.19.3 Error Response Structure

The following table describes the JSON structure in the event of a response error:

No.	Attribute	type	obligation	description
1.	code	number	required	Error code.
2.	text	string(4000)	required	Error message.

7.3.20 POST/gateway/order/data-hr-15min-history-changes

URL	POST/gateway/order/data-hr-15min-history-changes
Description	The method is intended for ordering "Net billing accounting scheme changes of interval data" report.
Parameters	URL parameters:

	The JSON data is contained in the HTTP request (BODY) (<i>see JSON structure, below</i>).		
Header	After decrypting the supplier authentication key, the supplier ID is used to select the data.		
JSON request	<pre>{ "dateFrom": "date", "dateTo": "date", "objectNumbers": ["string"] }</pre>		
Response HTTP code	HTTP status code	Reason	Description
	201	Created	The request has been successfully completed.
	400	Bad Request	Request error. The HTTP response body provides a list of errors in JSON format. (<i>Error response of the JSON structure below</i>).
	401	Unauthorized	An attempt was made to connect to a non-public method that requires authentication, but no user credentials were provided.
	403	Forbidden	According to the access control policy, the current user does not have access to perform the requested action.
	404	Not Found	Either there is no API method associated with the request URL path, or the request contains one or more parameters that did not return the data.
JSON response	<pre>{ "orderId": "integer" }</pre>		
JSON error response	<pre>{ "errorMessages": [</pre>		

```

{
  "code": "integer",
  "text": "string"
}
]
}

```

Rules	No.	Rule description	Error code	Error message	Attributes
	1.	The date from cannot be later than the date to but can be equal.	1002	Date from cannot be later than date to.	dateFrom, dateTo
	2.	The involved party will be identified by the authentication key.	1003	The involved party cannot be found in the system or involved party is not active.	-
	3.	The date from and date to cannot be later than the current date but can be equal.	1008	The date from and date to cannot be later than the current date.	dateFrom
	4.	Object meter must be automated.	2007	The submitted object number: [objectNumber (if there is more than one object, objects must be separated by the semicolon)] , was not found or the meter of object is not automated.	objectNumber
	5.	Date cannot be older than 36 months old.	2012	Date from cannot be older than 36 months old.	dateFrom
	6.	Report can be ordered maximum for 12 months.	2013	The report can only be ordered for 12 months or less.	dateFrom, dateTo
	7.	A maximum of [configured parameter] objects can be submitted in a report order.	2021	A maximum of {500} objects can be specified.	objectNumber
	8.	The meaning of the [ObjectNumber] notification cannot be repeated.	2028	The object: [objectNumber (if there is more than one object, objects must be separated by the semicolon)] is repeating.	objectNumber

7.3.20.1 JSON Request structure

The table below describes the structure of the JSON request:

No.	Attribute	Type	Obligation	Description
1.	dateFrom	date	required	The date from which we want to obtain information on possible recalculations of the objects. <ul style="list-style-type: none">The format: YYYY-MM-DD.
2.	dateTo	date	required	The date to which we want to obtain information on possible recalculations of the objects. <ul style="list-style-type: none">The format: YYYY-MM-DD.
3.	objectNumbers	["string"]	not required	Objects for which we want to check if there are possible recalculations.

7.3.20.2 JSON Response structure

The table below describes the structure of the JSON response:

No.	Attribute	Type	Obligation	Description
1.	orderId	integer	required	The report ordering primary surrogate key.

7.3.20.3 Error Response Structure

The following table describes the JSON structure in the event of a response error:

No.	Attribute	Type	Obligation	Description
1.	code	integer	required	Error code.
2.	text	string (4000)	required	Error message.

7.3.21 GET/gateway/order/{orderId}/data-hr-15min-history-changes

URL	GET/gateway/order/{orderId}/data-hr-15min-history-changes		
Description	The method is designed to obtain "Net billing accounting scheme changes of interval data" report.		
Parameters	<p>URL parameters:</p> <ul style="list-style-type: none"> • orderId – order identification number. • first - the index of the object, which must be the first in the return list (starting from 0). Optional. The default value is 0. • count - the number of objects in the return list. Optional. The default value is 10000. If no count value is given, the default value count will be 10000. 		
Header	After decrypting the supplier authentication key, the supplier ID is used to select the data.		
JSON request			
Response HTTP code	HTTP status code	Reason	Description
	200	OK	Request completed successfully.
	400	Bad Request	Request error. The HTTP response body provides a list of errors in JSON format. (<i>Error response of the JSON structure below</i>).
	401	Unauthorized	An attempt was made to connect to a non-public method that requires authentication, but no user credentials were provided.
	403	Forbidden	According to the access control policy, the current user does not have access to perform the requested action.
	404	Not Found	Either there is no API method associated with the request URL path, or the request contains one or more parameters that did not return the data.
JSON response	<pre>[{ "personCode": "string", "personName": "string",</pre>		

	<pre> "personSurname": "string", "objectNumber": "string", "periodsWithChanges": [{ "billingPeriod": "date", "reasons": ["string", "string"] }]] </pre>				
JSON error response	<pre> { "errorMessages": [{ "code": "integer", "text": "string" }] } </pre>				
Rules	No.	Rule description	Error code	Error message	Attributes
	1.	The order status must be Completed .	2010	Invalid report order status.	orderId
	2.	Report order doesn't exist in the system.	2016	According to the submitted order number: [orderId] , the order does not exist.	orderId
	3.	Invalid method selected for report data or incorrect parameter.	2017	Invalid method selected or parameter specified incorrectly. According to the submitted order number: [orderId] report type is: [orderType] .	orderId, orderType
	4.	No data found based on the search parameters submitted in the POST method.	2018	There is no data for the selected search parameters, the response is empty.	orderId

	5.	The number of objects in the return list must be less than or equal to 10000.	2022	The number of objects in the return list must be less than or equal to [10000].	count
--	----	---	------	--	-------

7.3.21.1 JSON Request structure

The table below describes the structure of the JSON request:

No.	Attribute	Type	Obligation	Description

7.3.21.1 JSON Response structure

The table below describes the structure of the JSON response:

No.	Attribute	Type	Obligation	Description
1.	personCode	string	required	Person / company code.
2.	personName	string	required	Person name / company name.
3.	personSurname	string	not required	Person surname.
4.	objectNumber	string (20)	required	Object number.
5.	periodWithChanges: []			
5.1	billingPeriod	date	required	Accounting period which has possible recalculations for consumption object. <ul style="list-style-type: none"> The format: YYYY-MM.

5.2	reasons	["string"]	required	Reasons for change: <ul style="list-style-type: none"> • GENERATION_CHANGE • OWNER_CHANGE • SUPPLIER_CHANGE
-----	---------	------------	----------	--

7.3.21.1 Error Response Structure

The following table describes the JSON structure in the event of a response error:

No.	Attribute	Type	Obligation	Description
1.	code	integer	required	Error code.
2.	text	string (4000)	required	Error message.

7.3.22 POST/gateway/order/balance-data (*will be deployed in 04.16*)

URL	POST /gateway/order/balance-data
Description	The method is intended for ordering balance data report.
Parameter	<p>URL parameters:</p> <p>The JSON data is contained in the HTTP request (BODY) (<i>see JSON structure, below</i>).</p>
Header	After decrypting the independent supplier authentication key, the independent supplier ID is used to select the data.
JSON request	<pre>{ "dateFrom": "date", "dateTo": "date",</pre>

	<pre>"interval": "string" }</pre>				
HTTP Response code	HTTP status code	Reason	Description		
	201	Created	Request is completed successfully.		
	400	Bad Request	Request error. The HTTP response body provides a list of errors in JSON format.		
	401	Unauthorized	An attempt was made to connect to a non-public method that requires authentication, but no user credentials were provided.		
	403	Forbidden	According to the access control policy, the current user does not have access to perform the requested action.		
	404	Not Found	Either there is no API method associated with the request URL path, or the request contains one or more parameters that did not return the data.		
JSON response	<pre>{ "orderId": "integer" }</pre>				
JSON error response	<pre>{ "errorMessages": [{ "code": "integer", "text": "string" }] }</pre>				
Rules	No.	Rule description	Error code	Error message	Attributes
	1.	The date from cannot be later than the date to. Equal can be.	1002	Date from cannot be later than date to.	dateFrom, dateTo

	2.	The date from and date to cannot be later than the current date but can be equal.	1008	Date from and date to cannot be later than the current date.	dateFrom, dateTo
	3.	Date cannot be older than 36 months old.	2012	Date from cannot be older than 36 months old.	dateFrom
	4.	Report can be ordered maximum for 1 accounting month.	2024	The report can only be ordered for 1 accounting month or less.	dateFrom, dateTo

7.3.22.1 JSON Request structure

The table below describes the structure of the JSON request:

No.	Attribute	Type	Obligation	Description
1.	dateFrom	date	required	The beginning date (inclusive) of the reporting period: <ul style="list-style-type: none"> The format: YYYY-MM-DD.
2.	dateTo	date	required	The end date of the reporting period: <ul style="list-style-type: none"> The format: YYYY-MM-DD.
3.	interval	date	required	Consumption interval. Possible meanings: <ul style="list-style-type: none"> HOUR QUARTER

7.3.22.2 JSON Response structure

The table below describes the structure of the JSON response:

No.	Attribute	Type	Obligation	Description
1.	orderId	integer	required	The report ordering primary surrogate key.

7.3.22.3 Error Response Structure

The following table describes the JSON structure in the event of a response error:

No.	Attribute	Type	Obligation	Description
1.	code	integer	required	Error code.
2.	text	string (4000)	required	Error message.

7.3.23 GET/gateway/order/{orderId}/balance-data (will be deployed in 04.16)

URL	GET /gateway/order/{orderId}/balance-data		
Description	The method is used to obtain the report "Balance data"		
Parameters	URL parameters: <ul style="list-style-type: none"> • orderId – order identification number. • first - the index of the object, which must be the first in the return list (starting from 0). Optional. The default value is 0. • count - the number of objects in the return list. Optional. The default value is 10000. If no count value is given, the default value count will be 10000. 		
Header	After decrypting the independent supplier's authentication key, the independent supplier's ID is used to select the data.		
JSON request			
Response HTTP code	HTTP status code	Reason	Description
	200	OK	Request is completed successfully.
	400	Bad Request	Request error. The HTTP response body provides a list of errors in JSON format. (<i>Error response of the JSON structure below</i>).

	401	Unauthorized	An attempt was made to connect to a non-public method that requires authentication, but no user credentials were provided.		
	403	Forbidden	According to the access control policy, the current user does not have access to perform the requested action.		
	404	Not Found	Either there is no API method associated with the request URL path, or the request contains one or more parameters that did not return the data.		
JSON response	<pre>{ "timeSeriesData": [{ "intervalDateTime": "dateTime", "valueOfGeneration": "double(10.3)", "valueOfConsumption": "double(10.3)" }] }</pre>				
JSON error response	<pre>{ "errorMessages": [{ "code": "integer", "text": "string" }] }</pre>				
Rules	No.	Rule description	Error code	Error message	Attributes
	1.	The order status must be Completed .	2010	Invalid report order status.	orderId
	2.	Report order doesn't exist in the system.	2016	According to the submitted order number: [orderId] , the order does not exist.	orderId

	3.	Invalid method selected for report data or incorrect parameter.	2017	Invalid method selected or parameter specified incorrectly. According to the submitted order number: [orderId] report type is: [orderType] .	orderId, orderType
	4.	No data found based on the search parameters submitted in the POST method.	2018	There is no data for the selected search parameters, the response is empty.	orderId
	5.	Data must be sorted by date ascending.	-	-	-

7.3.23.1 JSON Request structure

The table below describes the structure of the JSON request:

No.	Attribute	Type	Obligation	Description

7.3.23.2 JSON Response structure

The table below describes the structure of the JSON response:

No.	Attribute	Type	Obligation	Description
1.	timeSeriesData: []			
1.1	intervalDateTime	dateTime with timeZone	required	Date interval.
1.2	valueOfGeneration	double (10.3)	required	Total generated electricity in MWh.
1.3	valueOfConsumption	double (10.3)	required	Total consumed electricity in MWh.

7.3.23.3 Error Response Structure

The following table describes the JSON structure in the event of a response error:

No.	Attribute	Type	Obligation	Description
1.	code	integer	required	Error code.
2.	text	string (4000)	required	Error message.

7.3.24 POST/gateway/order/balance-by-generation-type (will be deployed in 04.16)

URL	POST /gateway/order/balance-by-generation-type
Description	The method is intended for ordering "Balance by generation type" report.
Parameter	<p>URL parameters:</p> <p>The JSON data is contained in the HTTP request (BODY) (see <i>JSON structure, below</i>).</p>
Header	After decrypting the independent supplier authentication key, the independent supplier ID is used to select the data.
JSON request	<pre>{ "generationType": "string", "generationCategory": ["string", "string"], "dateFrom": "date", "dateTo": "date", "interval": "string" }</pre>

HTTP Response code	HTTP status code	Reason	Description		
	201	Created	Request is completed successfully.		
	400	Bad Request	Request error. The HTTP response body provides a list of errors in JSON format.		
	401	Unauthorized	An attempt was made to connect to a non-public method that requires authentication, but no user credentials were provided.		
	403	Forbidden	According to the access control policy, the current user does not have access to perform the requested action.		
	404	Not Found	Either there is no API method associated with the request URL path, or the request contains one or more parameters that did not return the data.		
JSON response	<pre>{ "orderId": "integer" }</pre>				
JSON error response	<pre>{ "errorMessages": [{ "code": "integer", "text": "string" }] }</pre>				
Rules	No.	Rule description	Error code	Error message	Attributes
	1.	The date from cannot be later than the date to. Equal can be.	1002	Date from cannot be later than date to.	dateFrom, dateTo
	2.	The date from and date to cannot be later than the current date but can be equal.	1008	Date from and date to cannot be later than the current date.	dateFrom, dateTo

	3.	Date cannot be older than 36 months old.	2012	Date from cannot be older than 36 months old.	dateFrom
	4.	Report can be ordered maximum for 1 accounting month.	2024	The report can only be ordered for 1 accounting month or less.	dateFrom, dateTo

7.3.24.1 JSON Request structure

The table below describes the structure of the JSON request:

No.	Attribute	Type	Obligation	Description
1.	generationType	string	required	Generation type. Possible values: <ul style="list-style-type: none"> • A – Waste generation; • B – Biomass generation; • H – Hydroelectric generation; • K – Other generation; • S – Solar generation; • T – TEC generation; • V – Wind generation.
2.	generationCategory	string	not required	Producer's category. Possible values: <ul style="list-style-type: none"> • PRODUCERS – when generation type is one of these: A, B, H, K, S, T, V; • PROSUMERS - when generation type is one of these: H, S, V; • UNALLOCATED - when generation type is one of these: S, V; • REMOTE-PROSUMERS - when generation type is one of these: S, V.
3.	dateFrom	date	required	The beginning date (inclusive) of the reporting period: <ul style="list-style-type: none"> • The format: YYYY-MM-DD;
4.	dateTo	date	required	The end date of the reporting period: <ul style="list-style-type: none"> • The format: YYYY-MM-DD;
5.	interval	date	required	Consumption interval. Possible meanings: <ul style="list-style-type: none"> • HOUR • QUARTER

7.3.24.2 JSON Response structure

The table below describes the structure of the JSON response:

No.	Attribute	Type	Obligation	Description
1.	orderId	integer	required	The report ordering primary surrogate key.

7.3.24.3 Error Response Structure

The following table describes the JSON structure in the event of a response error:

No.	Attribute	Type	Obligation	Description
1.	code	integer	required	Error code.
2.	text	string (4000)	required	Error message.

7.3.25 GET/gateway/order/{orderId}/balance-by-generation-type (will be deployed in 04.16)

URL	GET/gateway/order/{orderId}/balance-by-generation-type
Description	The method is used to obtain the report "Balance by generation type"
Parameters	<p>URL parameters:</p> <ul style="list-style-type: none"> • orderId – order identification number. • first - the index of the object, which must be the first in the return list (starting from 0). Optional. The default value is 0. • count - the number of objects in the return list. Optional. The default value is 10000. If no count value is given, the default value count will be 10000.
Header	After decrypting the independent supplier's authentication key, the independent supplier's ID is used to select the data.
JSON request	

Response HTTP code	HTTP status code	Reason	Description
	200	OK	Request is completed successfully.
	400	Bad Request	Request error. The HTTP response body provides a list of errors in JSON format. (<i>Error response of the JSON structure below</i>).
	401	Unauthorized	An attempt was made to connect to a non-public method that requires authentication, but no user credentials were provided.
	403	Forbidden	According to the access control policy, the current user does not have access to perform the requested action.
	404	Not Found	Either there is no API method associated with the request URL path, or the request contains one or more parameters that did not return the data.
JSON response	<pre>[{ "generationType": "string", "timeSeriesData": [{ "intervalDateTime": "dateTime", "generationCategories": [{ "generationCategory": "string", "valueOfGeneration": "double(10.3)" }] }] }]</pre>		
JSON error response	<pre>{ "errorMessages": [</pre>		

	<pre> { "code": "integer", "text": "string" }] } </pre>				
Rules	No.	Rule description	Error code	Error message	Attributes
	1.	The order status must be Completed .	2010	Invalid report order status.	orderId
	2.	Report order doesn't exist in the system.	2016	According to the submitted order number: [orderId] , the order does not exist.	orderId
	3.	Invalid method selected for report data or incorrect parameter.	2017	Invalid method selected or parameter specified incorrectly. According to the submitted order number: [orderId] report type is: [orderType] .	orderId, orderType
	4.	No data found based on the search parameters submitted in the POST method.	2018	There is no data for the selected search parameters, the response is empty.	orderId
	5.	Data must be sorted by date ascending.	-	-	-

7.3.25.1 JSON Request structure

The table below describes the structure of the JSON request:

No.	Attribute	Type	Obligation	Description

7.3.25.2 JSON Response structure

The table below describes the structure of the JSON response:

No.	Attribute	Type	Obligation	Description
1.	generationType	string	required	Generation type. Possible values: <ul style="list-style-type: none"> • A – Waste generation; • B – Biomass generation; • H – Hydroelectric generation; • K – Other generation; • S – Solar generation; • T – TEC generation; • V – Wind generation.
2.	timeSeriesData: []			
2.1	intervalDateTime	dateTime with timeZone	required	Date interval.
2.2	generationCategories: []			
2.2.1	generationCategory	string	required	Producer's category. Possible values: <ul style="list-style-type: none"> • PRODUCERS – when generation type is one of these: A, B, H, K, S, T, V; • PROSUMERS - when generation type is one of these: H, S, V; • UNALLOCATED - when generation type is one of these: S, V; • REMOTE-PROSUMERS - when generation type is one of these: S, V.
2.2.2	valueOfGeneration	double (10.3)	required	Total generated electricity in MWh.

7.3.25.3 Error Response Structure

The following table describes the JSON structure in the event of a response error:

No.	Attribute	Type	Obligation	Description
1.	code	integer	required	Error code.
2.	text	string (4000)	required	Error message.

7.4 Object controller

7.4.1 POST /gateway/object/v2/my/active/list

URL	POST /gateway/object/v2/my/active/list?first={integer}&count={integer}&sortKey={string}&sortOrder={ASC/DSC}
Description	<p>The method is designed to obtain a list of valid objects in the contract according to the selection criteria. The method will be used before performing:</p> <ul style="list-style-type: none"> • owner change process • contract termination process • tariff plan change process
Parameter	<p>URL parameter:</p> <ul style="list-style-type: none"> • first - index (starting from 0) of the object that must be presented first in the return list. Optional. The default value is 0. • count - number of objects in the return list. Optional. The default value is 30. • sort - possible value ASD,DSC. <p>The data of the JSON form request are presented in the HTTP request body (BODY) (Query JSON structure, below).</p>
Header	After decrypting the supplier authentication key, the supplier ID is used to select the data.

Request	<pre>{ "personCode": "string", "consumerCode": "string", "objectNumber": "string", "meterNumber": "string", "showObjectMeter": "boolean", "showObjectPower": "boolean", "showObjectState": "boolean" }</pre>		
Response HTTP code	HTTP status code	Reason	Description
	200	OK	Request completed successfully.
	204	No content	No data found according to the given parameters.
	400	Bad request	Request error. The HTTP response body provides a list of errors in JSON format. (<i>Error response of the JSON structure below</i>).
	401	Unauthorized	An attempt was made to connect to a non-public method that requires authentication, but no user credentials were provided.
	403	Forbidden	According to the access control policy, the current user does not have access to perform the requested action.
	404	Not found	Either there is no API method associated with the request URL path, or the request contains one or more parameters that did not return the data.
Response	<pre>[{ "objectNumber": "string", "objectAddress": "string", "objectName": "string", "objectType": "string", "timeLimitedObjectValidTo": "datetime", "ownershipDocumentNumber": "string", "ownershipDocumentDate": "date", "auctionDate": "date", "technologicalCosts": "boolean",</pre>		

```
"productsAmount": "integer",
"scalesAmount": "integer",
"metersAmount": "integer",
"autoMetersAmount": "integer",
"supplier": {
  "supplierType": "string",
  "contractStart": "date",
  "contractEnd": "date",
  "contractModel": "string"
},
"objectStates": [
  {
    "stateType": "string",
    "state": "string",
    "stateValidFrom": "date",
    "stateValidTo": "date"
  }
],
"voltage": "double",
"powerPlantObjects": [
  {
    "powerPlantObjectNumber": "string",
    "powerPlantType": "string",
    "generatingPower": "double"
  }
],
"objectPowers": [
  {
    "powerType": "string",
    "power": "double",
    "reliabilityCategoryType": "string",
    "powerValidFrom": "date",
    "powerValidTo": "date"
  }
],
"generatingObject": {
```

```
"generatingObjectType": "string",
"payoffMethod": "string",
"generatingObjectPower": "double",
"generatingObjectTypeFrom": "date",
"generatingObjectTypeTo": "date",
"payoffMethodChangeDate": "date"
},
"tariff": {
  "tariffPlan": "string",
  "timeZone": "string",
  "tariffPlanChangeDate": "date"
},
"meters": [
  {
    "meterNumber": "string",
    "meterTypeName": "string",
    "meterScaleLength": "integer",
    "conversionPoss": "boolean",
    "meterAutomated": "boolean",
    "scales": [
      {
        "scaleIdentifier": "string",
        "scaleProduct": "string"
      }
    ]
  }
],
"contract": {
  "consumerCode": "string",
  "contractType": "string",
  "personName": "string",
  "personSurname": "string",
  "personCode": "string",
  "personType": "string",
  "personIndividual": "boolean",
  "sociallyVulnerable": "boolean",
```

```

"contact": {
  "mobPhoneNoNetwork": "string",
  "mobPhoneNo2Network": "string",
  "mobPhoneInvoice": "string",
  "phoneNoNetwork": "string",
  "emailNetwork": "string",
  "email2Network": "string",
  "emailInvoice": "string",
  "correspondenceAddress": "string",
  "mobPhoneNoObject": "string"
}
},
"consumptionAverage": "double",
"consumptionAverageCalculationDate": "datetime",
"consumptionAverageCalculationMonthsCount": "integer"
}
]

```

```

{
  "errorMessagees": [
    {
      "code": 0,
      "text": "string"
    }
  ]
}

```

Rules	No.	Rule description	Error code	Error message	Attributes
	1.	If an attribute has defined possible values, the value index can be specified by specifying the value of the attribute in the request. Indices of all possible values start from 0.	-	-	-
	2.	One or more request parameters are required.	1001	One or more request parameters are required.	personCode, consumerCode, objectNumber,

					meterNumber
3.	<p>No data found according to the given parameters.</p> <p>The returned set of objects is defined:</p> <ul style="list-style-type: none"> • Only the valid objects of the current supplier must be returned; 	HTTP 204	-		supplyOwnership, contractStart, contractEnd
4.	<p>The request parameter [showObjectMeter] values must be:</p> <ul style="list-style-type: none"> • True or • False 	-	-		showObjectMeter
5.	<p>The request parameter [showObjectPower] values must be:</p> <ul style="list-style-type: none"> • True or • False 	-	-		
6.	<p>The request parameter [showObjectState] values must be:</p> <ul style="list-style-type: none"> • True or • False 	-	-		showObjectState

7.4.1.1 JSON Request structure

The table below describes the structure of the JSON response:

No.	Attribute	Type	Obligation	Description
1.	personCode	String(20)	not required	Contract owner / tenant / company code.
2.	consumerCode	String(20)	not required	Contract owner / tenant consumer code.
3.	objectNumber	String(20)	not required	Object number.
4.	meterNumber	String(20)	not required	Meter number.
5.	showObjectMeter	Boolean	not required	Indication of whether meter information should be retrieved.
6.	showObjectPower	Boolean	not required	Indication of whether power information should be retrieved.
7.	showObjectState	Boolean	not required	Indication of whether object status information should be retrieved.

7.4.1.2 JSON Response structure

The table below describes the structure of the JSON response:

No	Attribute	Type	Obligation	Description
1	objectNumber	String(20)	required	Object number.
3	objectAddress	String(4000)	required	Full address of the object.
5	objectName	String(200)	not required	Object name.
6	objectType	String(200)	not required	Object type name.
7	timeLimitedObjectValidTo	Date	not required	Expire date of the term object.
8	ownershipDocumentNumber	String(20)	not required	Ownership document number.
9	ownershipDocumentDate	Date	not required	Ownership document date of number.

No	Attribute	Type	Obligation	Description
10	auctionDate	Date	not required	Date of acquisition of the object from the auction.
11	technologicalCosts	Boolean	not required	Indicator or object according to the latest data is accounted for technological costs.
12	productAmount	Number	not required	Products' amounts are counted at the level of the object.
13	scalesAmount	Number	not required	Scales' amounts are counted at the level of the object.
14	metersAmount	Number	not required	Meters' amounts are counted at the level of the object.
15	autoMetersAmount	Number	not required	Automated meters' amounts are counted at the level of the object.
16	supplier: {}			
16.1	supplierType	String(2)	required	Current supplier type. Possible meanings: <ul style="list-style-type: none"> • VT - public supplier; • GT - warranty supplier; • NT - independent supplier.
16.2	contractStart	Date	required	Start date of entry into force of the object at a supplier. (NT/VT/GT)
16.3	contractEnd	Date	not required	End date of entry into force of the object at a supplier. (NT/VT/GT)
16.4	contractModel	String(10)	required	Contract model of the object at a supplier (NT/VT/GT). Contract model of the current object. Possible meanings: <ul style="list-style-type: none"> • BSS - General contract bills; • 2S2S - Two contracts – Two bills.
17	objectStates: {}			
17.1	stateType	String(3)	not required	Object state type. Possible meanings:

No	Attribute	Type	Obligation	Description
				<ul style="list-style-type: none"> • ETB - Supply state; • VBS - Consumption state.
17.2	state	String	not required	<p>Power supply state of the object. Possible meanings:</p> <ul style="list-style-type: none"> • T - Supply; • P - Disconnected on request; • A - Disconnected under sanction; • R - Limited by sanction. <p>Power consumption state of the object. Possible meanings:</p> <ul style="list-style-type: none"> • N – Temporarily inactive; • V - Consuming; • A - Alleged.
17.3	stateValidFrom	Date	not required	Object state valid from.
17.4	stateValidTo	Date	not required	Object state valid to.
18.	voltage	Double(5,2)	not required	Object voltage, kV.
19	powerPlantObjects:[]			
19.1	powerPlantObjectNumber	String(20)	not required	Power plant object number.
19.2	powerPlantType	String(1)	not required	<p>Type of the power plant. Possible meanings:</p> <ul style="list-style-type: none"> • A - Waste • B - Biomass • H - Hydroelectric • K - Other • S - Solar • T - TEC

No	Attribute	Type	Obligation	Description
				<ul style="list-style-type: none"> V - Wind
19.3	generatingPower	Double(10,3)	Not required	The power generated by assigned power plant.
20	objectPowers:[]			
20.1	powerType	String(3)	not required	<p>Object power type. Possible meanings:</p> <ul style="list-style-type: none"> LOG - Permissible power consumption.; LGG - Permissible power generation; IOG - Installed usable power; IGG - Installed to generate power.
20.2	power	Double(10,3)	not required	Object power.
20.3	powerValidFrom	Date	not required	Object power valid from.
20.4	powerValidTo	Date	not required	Object power valid to.
20.5	reliabilityCategoryType	String(1)	not required	<p>Type of credibility of supply category. Possible meanings:</p> <ul style="list-style-type: none"> 1 - 1 category; 2 - 2 category; 3 - 3 category.
21	generatingObject: {}			
21.1	generatingObjectType	String(1)	not required	<p>Generating consumer type. Possible meanings:</p> <ul style="list-style-type: none"> G – GV (Generating consumer); N – NGV (Distant generating consumer).
21.2	payoffMethod	String(1)	not required	Generating consumer payoff method. Possible meanings:

No	Attribute	Type	Obligation	Description
				<ul style="list-style-type: none"> • E – kWh – Recovered el. energy; • G - kW – Power plant installed capacity; • M - kWh ir kW – Mixed; • P - % - Payment percentage, • S – kWh – PP recovered electricity
21.3	generatingObjectPower	Double(10,3)	not required	Generating object power.
21.4	generatingObjectTypeFrom	Date	not required	Generating consumer type valid from.
21.5	generatingObjectTypeTo	Date	not required	Generating consumer type valid to.
21.6	payoffMethodChangeDate	Date	not required	Payoff method change date.
22	tariff: {}			
22.1	tariffPlan	String(200)	not required	Tariff plan name.
22.2	timeZone	String	not required	Object time zone. Possible meaning: <ul style="list-style-type: none"> • 1 - One; • 2 - Two; • VR - One with reactive; • 4 - Four (Smart); • DR - Differentiated with reactive; • N - Not established.
22.3	tariffPlanChangeDate	Date	not required	Date of the tariff plan change.
23	meters: []			
23.1	meterNumber	String(20)	required	Object meter number.
23.2	meterTypeName	String	not required	Meter type name.

No	Attribute	Type	Obligation	Description
23.3	meterScaleLength	Integer	not required	Maximum number of scale marks installed (programmable) in the meter.
23.4	conversionPoss	Boolean	required	Indication of whether conversion of the total readings of the meter scales is possible.
23.5	meterAutomated	Boolean	required	Indication of whether the meter has automated accounting.
23.6	scales: []			
23.6.1	scaleIdentifier	String	required	<p>Internal scale identifier. Possible meanings:</p> <ul style="list-style-type: none"> • VT; • DD; • DN; • +QsumTS; • +WsumT1; • +WsumT2; • +WsumT3; • +WsumT4; • -QsumTS; • -WsumTS.
23.6.2	scaleProduct	String	required	<p>Internal scale product. Possible values:</p> <ul style="list-style-type: none"> • D1 – day electricity; • D2 – evening electricity; • DD – electricity at day tariff; • MA- maximum loads; • MI – minimum loads; • N1 – night electricity; • N2 – morning electricity; • NK – electricity at night, Saturday, Sunday tariff; • RG- reactive electricity generated; • RV – reactive electricity consumption; • SV – Saturdays, Sundays, and holidays electricity; • VD – average loads; • VK - one time zone.

No	Attribute	Type	Obligation	Description
24	contract: {}			
24.1	consumerCode	String(20)	required	Contract owner consumer code.
24.2	contractType	String(10)	required	Contract type. Possible meanings: <ul style="list-style-type: none"> • SBTS - Household contract; • SKMS - Commercial contract.
24.3	personName	String(200)	required	Contract owner name / company name.
24.4	personSurname	String(50)	not required	Contract owner surname.
24.5	personCode	String(20)	not required	Contract owner person / company code If the subject is individual, that person code must be encrypted: [*****][person code's 3 last symbols]
24.6	personType	String(10)	required	Contract owner / tenant person type. Possible meaning: <ul style="list-style-type: none"> • FAS - individual; • JAS - Juridical.
24.7	personIndividual	Boolean	required	Indication of whether the contract owner / tenant is individual person.
24.8	sociallyVulnerable	Boolean	required	An indication of whether the owner/tenant of the object is socially vulnerable.
25	contact: {}			
25.1	mobPhoneNoNetwork	String(12)	not required	Mobile phone number for network.
25.2	mobPhoneNo2Network	String(12)	not required	Extra mobile phone number for the network.
25.3	phoneNoNetwork	String(12)	not required	Phone number for network.
25.4	mobPhoneInvoice	String(12)	not required	Mobile phone number for invoice.

No	Attribute	Type	Obligation	Description
				Data has been returned if contract type is SKMS.
25.5	emailNetwork	String(49)	not required	Email address for the network.
25.6	email2Network	String(49)	not required	Extra email address for the network.
25.7	emailInvoice	String(50)	not required	Email address for the invoice. Data has been returned if the contract type is SKMS.
25.7	correspondenceAddress	String(4000)	not required	Correspondence address full name.
25.8	mobPhoneNoObject	String(12)	not required	Extra mobile phone number for failures. Data has been returned if the contract type is SKMS.
26.	consumptionAverage	Double(15,2)	not required	P plus consumption average.
27.	consumptionAverageCalculationDate	DateTime	not required	Date of consumption average calculation.
28.	consumptionAverageCalculationMonthsCount	Integer	Not required	Months count of consumption average calculation.

7.4.1.3 Error Response structure

The following table describes the JSON structure in the event of a response error:

No.	Attribute	type	obligation	description
1.	code	number	required	Error code.
2.	text	string(4000)	required	Error message.

7.4.2 POST /gateway/object/v2/all/active/list

URL	POST /gateway/object/v2/all/active/list?first={integer}&count={integer}&sortKey={string}&sortOrder={ASC/DSC}		
Description	<p>The method is to obtain a list of objects at the time of awarding the contract, according to the selection criteria. The method will be used before performing:</p> <ul style="list-style-type: none"> • Owner and supplier change process • Supply change process 		
Parameters	<p>URL:</p> <ul style="list-style-type: none"> • first - index (starting from 0) of the object that must be presented first in the return list. Optional. The default value is 0. • count - number of objects in the return list. Optional. The default value is 30. • sort - possible values ASC, DSC. <p>The data of the JSON form request are presented in the HTTP request body (BODY) (Query JSON structure, below).</p>		
Header	After decrypting the supplier authentication key, the supplier ID is used to select the data.		
JSON request	<pre>{ "personCode": "string", "consumerCode": "string", "objectNumber": "string", "meterNumber": "string" "objectDataConsentSign": "boolean" }</pre>		
Response HTTP code	HTTP status code	Reason	Description
	200	OK	Request completed successfully
	204	No Content	No data found according to the given parameters.
	400	Bad Request	Request error. The HTTP response body provides a list of errors in JSON format. (<i>Error response of the JSON structure below</i>).
	401	Unauthorized	An attempt was made to connect to a non-public method that requires authentication, but no user credentials were provided.
	403	Forbidden	According to the access control policy, the current user does not have access to perform the requested action.

	404	Not Found	Either there is no API method associated with the request URL path, or the request contains one or more parameters that did not return the data.
JSON response	<pre>[{ "personName": "string", "personSurname": "string", "personCode": "string", "consumerCode": "string", "objectNumber": "string", "metersAmount": "integer", "autoMetersAmount": "integer", "smartMeterInstallationDate": "date", "meters": [{ "meterNumber": "string", "meterAutomated": "boolean", "automationSystem": "string", "meterScaleLength": "integer", "scales": [{ "scaleIdentifier": "string", "scaleProduct": "string" }] }] }, "objectAddress": "string", "contractType": "string", "contractModel": "string", "supplierType": "string", "timeLimitedObjectValidTo": "datetime", "tariffPlan": "string", "tariffPlanChangeDate": "date", "timeZone": "string", "generatingObjectType": "string",</pre>		

```
"payoffMethod": "string",
"payoffMethodChangeDate": "date",
"ownershipDocumentNumber": "string",
"supplyOwnership": "string",
"contractStart": "date",
"contractEnd": "date",
"objectFutureSuppliers": [
  {
    "supplierCode": "string",
    "supplierName": "string",
    "contractStart": "date",
    "contractEnd": "date"
  }
],
"powerPlantObjects": [
  {
    "powerPlantObjectNumber": "string",
    "powerPlantType": "string",
    "generatingPower": "double"
  }
],
"generatingObjectPower": "double",
"objectPowers": [
  {
    "powerType": "string",
    "power": "double",
    "powerValidFrom": "date",
    "powerValidTo": "date"
  }
],
"objectLatestSupplyState": {
  "state": "string",
  "stateValidFrom": "date",
  "stateValidTo": "date"
},
"consumptionAverage": "double",
```

	<pre> "consumptionAverageCalculationDate": "datetime", "consumptionAverageCalculationMonthsCount": "integer" }] </pre>				
JSON error response	<pre> { "errorMessages": [{ "code": 0, "text": "string" }] } </pre>				
Rules	No.	Rule description	Error code	Error message	Attributes
	0.	If an attribute has defined possible values, the value index can be specified by specifying the value of the attribute in the request. Indices of all possible values start from 0.	-	-	All attributes with specified values.
	1.	One or more request parameters are required.	1001	One or more request parameters are required.	personCode, consumerCode, objectNumber, meterNumber
	2.	No data found according to the given parameters. The returned set of objects is defined: <ul style="list-style-type: none"> Valid contract objects of all suppliers' must be returned. 	HTTP 204	-	contract.conclusion_date
	3.	The request parameter [objectDataConsentSign] =TRUE is required.	47	It is mandatory to specify a request parameter in order to obtain consent to see object information.	objectDataConsentSign
	4.	The attribute [objectDataConsentSign] values must be: <ul style="list-style-type: none"> True or False. 	-	-	objectDataConsentSign

	5.	A maximum of 500 objects can be specified.	2021	A maximum of 500 objects can be specified.	objectNumbers
--	----	--	------	--	---------------

7.4.2.1 JSON Request structure

The table below describes the structure of the JSON response:

No.	Attribute	type	obligation	description
1.	personCode	String(20)	not required	Person / company code.
2.	consumerCode	String(20)	not required	Consumer code.
3.	objectNumbers	["string"]	not required	Object number. A maximum of 500 objects can be specified
4.	meterNumber	String(20)	not required	Meter number.
5.	objectDataConsentSign	Boolean	not required	Object data consent sing. True or False.

7.4.2.2 JSON Response structure

The table below describes the structure of the JSON response:

No.	Attribute	type	obligation	description
1.	personName	String(200)	required	Contract owner / tenant name / company name.
2.	personSurname	String(50)	not required	Contract owner / tenant surname.
3.	personCode	String(20)	not required	Contract owner / tenant person / company code. If the subject is individual, that person code must be encrypted: [*****][person code's 3 last symbols]
4.	consumerCode	String(20)	required	Contract owner / tenant consumer code.
5.	objectNumber	String(20)	required	Object number.

No.	Attribute	type	obligation	description
6.	meterAmount	Number	not required	The number of meters is calculated at the object level.
7.	autoMetersAmount	Number	not required	The number of automated meters is calculated at the object level.
8.	smartMeterInstallationDate	Date	not required	Date of installation of the object`s smart meter.
9.	meters: []			
9.1.	meterNumber	String(20)	required	Number of the object meter.
9.2.	meterAutomated	Boolean	required	An indication of whether the meter has automated accounting.
9.3.	automationSystem	String(20)	not required	Automated meter system. Possible values: <ul style="list-style-type: none"> • MDM (new MDM system, smart meters) • EMCOS (existing EMCOS system, automated meters) • NULL
9.4	meterScaleLenght	Integer	required	Maximum number of scale marks installed (programmable) in the meter.
9.5	scales: []			
9.5.1	scaleIdentifier	String	required	Internal scale identifier. Possible meanings: <ul style="list-style-type: none"> • VT; • DD; • DN; • +QsumTS; • +WsumT1; • +WsumT2; • +WsumT3; • +WsumT4; • -QsumTS; • -WsumTS.
9.5.2	scaleProduct	String	required	Internal scale product. Possible values: <ul style="list-style-type: none"> • D1 – day electricity;

No.	Attribute	type	obligation	description
				<ul style="list-style-type: none"> • D2 – evening electricity; • DD – electricity at day tariff; • MA- maximum loads; • MI – minimum loads; • N1 – night electricity; • N2 – morning electricity; • NK – electricity at night, Saturday, Sunday tariff; • RG- reactive electricity generated; • RV – reactive electricity consumption; • SV – Saturdays, Sundays, and holidays electricity; • VD – average loads; • VK - one time zone.
10.	objectAddress	String(4000)	required	Full title of the object address.
11.	contractType	String(10)	required	Contract type of the current object. Possible meanings: <ul style="list-style-type: none"> • SBTS - Household customer; • SKMS - Commercial customer.
12.	contractModel	String(10)	required	Contract model of the current object. Possible meanings: <ul style="list-style-type: none"> • BSS - General contract bills; • 2S2S - Two contracts – Two bills.
13.	supplierType	String(2)	not required	Current supplier type. Possible meanings: <ul style="list-style-type: none"> • VT - public supplier; • GT - warranty supplier; • NT - independent supplier.
14.	timeLimitedObjectValidTo	DateTime	not required	Expiry date of the time-limited object
15.	tariffPlan	String(200)	required	Current tariff plan of the object.
16.	tariffPlanChangeDate	Date	Not required	Tariff plan change date.

No.	Attribute	type	obligation	description
17.	timeZone	String(2)	required	<p>Current time zone of the object. Possible meanings:</p> <ul style="list-style-type: none"> • 1 - One; • 2 - Two; • VR - One with reactive; • 4 - Four (Smart); • DR - Differentiated with reactive; • N - Not established.
18.	generatingObjectType	String(1)	not required	<p>Generating consumer type. Possible meanings:</p> <ul style="list-style-type: none"> • G – GV (Generating consumer); • N – NGV (Distant generating consumer).
19.	payoffMethod	String(1)	not required	<p>Current pay of method of the generating consumer. Possible meanings:</p> <ul style="list-style-type: none"> • E – kWh – Recovered electricity; • G - kW – The power plant's permissible power; • P - % - Payment percentage; • S – kWh – PP recovered electricity.
20.	payoffMethodChangeDate	Date	not required	Payoff method change date.
21.	ownershipDocumentNumber	String(20)	not required	Ownership document number.
22.	supplyOwnership	String(20)	not required	<p>Possible values:</p> <ul style="list-style-type: none"> • MY - the object belongs to the independent supplier; • NOT_MY - the object does not belong to the independent supplier. <p>Note: For VT / GT case, the value NOT_MY will always be returned. For NT case, the value will be returned according to whether the supplier initiating the action coincides with the supplier of the object.</p>
23.	contractStart	Date	not required	<p>Contract start date with independent supplier. Returns only if supplyOwnership = MY. Otherwise, NULL is returned.</p>

No.	Attribute	type	obligation	description
24.	contractEnd	Date	not required	Contract end date with independent supplier. Returns only if supplyOwnership = MY. Otherwise, NULL is returned.
25	objectFutureSuppliers:[]			
25.1	supplierCode	String	not required	Future independent supplier code.
25.2	supplierName	String	not required	Future independent supplier name.
25.3	contractStart	Date	not required	Contract start date with future independent supplier.
25.4	contractEnd	Date	not required	Contract end date with future independent supplier.
26.	powerPlantObjects: []			
26.1	powerPlantObjectNumber	String(20)	not required	Power plant object number.
26.2	powerPlantType	String(1)	not required	Type of the power plant. Possible meanings: <ul style="list-style-type: none"> • A - Waist • B - Biomass • H - Hydroelectric • K - Other • S - Solar • T – TEC • V - Wind
26.3	generatingPower	Double(10,3)	not required	The power generated by assigned power plant.

No.	Attribute	type	obligation	description
27.	generatingObjectPower	Double(10,3)	not required	Generating object power.
28.	objectPowers:[]			
28.1	powerType	String(3)	not required	Object power type. Possible meanings: <ul style="list-style-type: none"> • LOG - Permissible power consumption.; • LGG - Permissible power generation; • IOG - Installed usable power; • IGG - Installed to generate power.
28.2	power	Double(10,3)	not required	Object power.
28.3	powerValidFrom	Date	not required	Object power valid from.
28.4	powerValidTo	Date	not required	Object power valid to.
29.	objectLatestSupplyState			
29.1	state	String	not required	Power supply state of the object. Possible meanings: <ul style="list-style-type: none"> • T – Supply; • P – Disconnected on request; • A – Disconnected under sanction; • R – Limited by sanction.
29.2	stateValidFrom	Date	not required	Object state valid from.
29.3	stateValidTo	Date	not required	Object state valid to.
30.	consumptionAverage	Double(15,2)	not required	Consumption average.

No.	Attribute	type	obligation	description
31.	consumptionAverageCalculationDate	Datetime	not required	Date of consumption average calculation.
32.	consumptionAverageCalculationMonthsCount	Integer	not required	Months count of consumption average calculation.

7.4.2.3 Error Response structure

The following table describes the JSON structure in the event of a response error:

No.	Attribute	type	obligation	description
1.	code	number	required	Error code.
2.	text	string(4000)	required	Error message.

7.5 Notification contract controller

7.5.1 POST /gateway/notification/v2/contract/list

URI	POST /gateway/notification/v2/contract/list?first={integer}&count={integer}&sortOrder={ASC/DSC}
Description	Method to obtain change information of the contract owner / contract owner and supplier / supplier.
Parameters	<p>URL parameters:</p> <ul style="list-style-type: none">• first - the index of the notification, which must be the first in the return list (starting from 0). Optional. The default value is 0.• count - the number of notification rows in the return list. Optional. The default value is 30.• sort - possible values ASC, DSC. <p>The data of the JSON form request are presented in the HTTP request body (BODY) (Query JSON structure, below).</p>
Header	After decrypting the supplier authentication key, the supplier ID is used to select the data.
JSON request	<pre>{ "personCode": "string", "objectNumber": "string", "notificationId": "number", "contractStartFrom": "date", "contractStartTo": "date", "submittedDateFrom": "datetime", "submittedDateTo": "datetime", "latestStatuses": ["string"], "userNameSearch": "string", "changeTypes": ["string"], "supplierContractNo": "string", "objectAddressSearch": "string", "declared": "boolean" }</pre>

	}		
Response HTTP code	HTTP status code	Reason	Description
	200	OK	Request completed successfully
	204	No Content	No data found according to the given parameters.
	400	Bad Request	Request error. The HTTP response body provides a list of errors in JSON format. (<i>Error response of the JSON structure below</i>).
	401	Unauthorized	An attempt was made to connect to a non-public method that requires authentication, but no user credentials were provided.
	403	Forbidden	According to the access control policy, the current user does not have access to perform the requested action.
	404	Not Found	Either there is no API method associated with the request URL path, or the request contains one or more parameters that did not return the data.
JSON response	<pre>[{ "notificationId": "integer", "changeType": "string", "contractType": "string", "contractStart": "date", "supplierContractNo": "string", "notes": "string", "userName": "string", "submittedDate": "dateTime", "latestStatus": "string", "errorType": "string", "correspondenceAddress": { "addressLine": "string", "street": "string", "building": "string", "housingNo": "string",</pre>		

```
"apartment": "string",
"locality": "string",
"eldership": "string",
"municipality": "string",
"county": "string"
},
"ownerInfo": {
  "subjectType": "string",
  "personName": "string",
  "personSurname": "string",
  "personCode": "string",
  "birthDate": "date",
  "vatCode": "string",
  "representativeName": "string",
  "representativeSurname": "string",
  "representativeDuty": "string",
  "contacts": {
    "mobPhoneNoNetwork": "string",
    "mobPhoneNo2Network": "string",
    "mobPhoneNoInvoice": "string",
    "telPhoneNoNetwork": "string",
    "emailNetwork": "string",
    "email2Network": "string",
    "emailInvoice": "string"
  }
},
"contractNotificationStatus": [
  {
    "status": "string",
    "statusDate": "datetime"
  }
],
"objects": [
  {
    "objectNumber": "string",
    "objectAddress": "string",
```

```

"contractModel": "string",
"tariffPlan": "string",
"timeZone": "string",
"payoffMethod": "string",
"objectNtr": "string",
"objectNtrDate": "date",
"uniqueRoomNo": "string",
"ntGetCoownerConsent": "boolean",
"auctionDate": "date",
"anotherSupplierContractCancellation": "string",
"cancelledByAnotherSupplier": "boolean",
"meterDeclarations": [
  {
    "meterNumber": "string",
    "meterReadings": [
      {
        "scaleIdentifier": "string",
        "scaleProduct": "string",
        "readingValue": "integer",
        "readingValueDate": "date"
      }
    ]
  }
],
"oldContractInfo": [
  {
    "contractType": "string",
    "consumerCode": "string",
    "object": {
      "objectNumber": "string",
      "meterNumbers": [
        "string"
      ],
      "objectAddress": "string",

```

	<pre> "contractModel": "string", "tariffPlan": "string", "timeZone": "string", "ownershipDocumentNumber": "string", "ntGetCoownerConsent": "boolean", "auctionDate": "datetime", "payoffMethod": "string" } }] </pre>				
JSON error response	<pre> { "errorMessages": [{ "code": "integer", "text": "string" }] } </pre>				
Rules	No.	Rule description	Error code	Error message	Attributes
	0.	If an attribute has defined possible values, the value index can be specified by specifying the value of the attribute in the request. Indices of all possible values start from 0.	-	-	All attributes with specified values.
	1.	No data found according to the given parameters.	HTTP 204	-	-
	2.	The date from cannot be later than the date to. Equal can be.	1002	Date from cannot be later than date to.	submittedDateFrom, submittedDateTo, contractStartDateFrom, contractStartDateTo

	3.	The value of the count parameter must be less or equal to 10000.	1007	The value of the count parameter must be less or equal to 10000.	Count
	4.	Submitted date cannot be later than the current date but can be equal.	1010	Submitted date cannot be later than the current date.	submittedDateFrom, submittedDateTo

7.5.1.1 JSON Request structure

The table below describes the structure of the JSON response:

No.	Attribute	type	obligation	description
1.	personCode	String(20)	not required	Person / company code.
2.	objectNumber	String(20)	not required	Object number.
3.	notificationId	Integer	not required	Notification ID.
4.	contractStartFrom	Date	not required	Contract start date from.
5.	contractStartTo	Date	not required	Contract start date to.
6.	submittedDateFrom	Datetime	not required	Submitted date from.
7.	submittedDateTo	Datetime	not required	Submitted date to.
8.	latestStatuses	[String]	not required	Notification status. Possible meanings: <ul style="list-style-type: none"> • P – Submitted • I - Sent • A - Cancelled • V - In progress • IV - Completed • K – Error

No.	Attribute	type	obligation	description
				More then one type can be submitted.
9.	userNameSearch	String(240)	not required	The user who created a notification.
10.	changeTye	[String]	not required	Change type. Possible meanings: SK - Owner change; STK - Owner and supplier change; NTK – Supplier change.
11.	supplierContractNo	String(30)	not required	Supplier contract number.
12.	objectAddressSearch	String(4000)	not required	Object full address.
13.	declared	Boolean	not required	Indication that there is meter scales declarations. Possible meanings: <ul style="list-style-type: none"> • TRUE • FALSE

7.5.1.2 JSON Response structure

The table below describes the structure of the JSON response:

No.	Attribute	type	obligation	description
1.	notificationId	Integer	required	Notification ID.
2.	changeType	String(10)	required	Change type. Possible meanings: <ul style="list-style-type: none"> • SK - Owner change; • STK - Owner and supplier change; • NTK – Supplier change.
3.	contractType	String(10)	required	Contract type. Possible meanings:

No.	Attribute	type	obligation	description
				<ul style="list-style-type: none"> • SBTS - Household contract; • SKMS - Commercial contract.
4.	contractStart	Date	required	Date of entry into force of the notification subject to the independent supplier from.
5.	supplierContractNo	String(30)	not required	<p>Contract number.</p> <p>Must be completed and is mandatory only in the change of owner and supplier / change of supplier.</p>
6.	notes	String(4000)	not required	Notes.
7.	userName	String(240)	not required	The user, who created the post.
8.	submittedDate	datetime	required	Submitted date of notification.
9.	latestSatus	String(10)	required	Latest status of notification.
10.	errorType	String(10)	not required	<p>Notification error type if status=K (Error). Possible meanings:</p> <ul style="list-style-type: none"> • SP - The contract has already been rewritten • KL - Incorrect message • AG - Invalid person code / birth data • SN - Change of owner is not possible because the data in the old contract does not match • SK - The owner has a contract, the change of owner is not possible for the same person • DL - The owner has a contract, the independent supplier is assigned to the object. • NT - Cancellation at the Supplier's request • NO - client is not the owner of the object <p>Notification error type if status='IV' (Completed). Possible meanings:</p> <ul style="list-style-type: none"> • RP - The contract has been rewritten but the meter scale(s) declarations have not been accepted by ESO, please submit the meter scale(s) declarations via the NT Portal.

correspondenceAddress

No.	Attribute	type	obligation	description
11.	addressLine	String(4000)	not required	Not structured full address title.
12.	street	String(200)	not required	Street.
13.	building	String(100)	not required	House.
14.	housingNo	String(100)	not required	Housing.
15.	apartment	String(20)	not required	Flat.
16.	locality	String(200)	not required	Town / Village.
17.	eldership	String(200)	not required	Eldership.
18.	municipality	String(200)	not required	Municipality.
19.	county	String(200)	not required	Country.
ownerInfo				
20.	subjectType	String(10)	required	Contract owner / tenant person type. Possible meanings: FAS - individual; JAS - Juridical.
21.	personName	String(200)	required	Contract owner / tenant / company name.
22.	personSurname	String(50)	not required	Contract owner / tenant surname.
23.	personCode	String(20)	not required	Contract owner / tenant person / company code
24.	birthDate	Date	not required	Contract owner / tenant birth date.
25.	vatCode	String(15)	not required	Contract owner / tenant VAT code.
26.	representativeName	String(50)	not required	Representative name.
27.	representativeSurname	String(50)	not required	Representative surname.
28.	representativeDuty	String(100)	not required	Representative duty.

No.	Attribute	type	obligation	description
ownerInfo.contacts				
29.	mobPhoneNoNetwork	String(12)	not required	Mobile phone number for networks. Contact details for information on network work (accounting maintenance, electrical disconnections and faults).
30.	mobPhoneNo2Network	String(12)	not required	Mobile phone number 2 for networks. Contact details for information on network work (accounting maintenance, electrical disconnections and faults).
31.	mobPhoneNoInvoice	String(12)	not required	Mobile phone number for bills. Contact details for informing about formed invoices and provided services.
32.	telPhoneNoNetwork	String(12)	not required	Phone number for networks. Contact details for information on network work (accounting maintenance, electrical disconnections and faults).
33.	emailNetwork	String(49)	not required	An email address for networks. Contact details for information on network work (accounting maintenance, electrical disconnections and faults).
34.	email2Network	String(49)	not required	An email address 2 for networks. Contact details for information on network work (accounting maintenance, electrical disconnections and faults).
35.	emailInvoice	String(100)	not required	An email address for bills. Contact details for informing about formed invoices and provided services.
contractNotificationStatus(Status of the contract change notification)				
36.	status	String(10)	required	Notification status. Possible meanings: P – Submitted I - Sent A - Cancelled V - In progress

No.	Attribute	type	obligation	description
				IV - Completed K - Error.
37.	statusDate	DateTime	required	Status date.
objects: []				
38.	objectNumber	String(20)	required	Object number.
39.	objectAddress	String(4000)	required	Object address.
40.	contractModel	String(10)	required	Contract model of the current object. Possible meanings: BSS - General contract bills; 2S2S - Two contracts – Two bills.
41.	tariffPlan	String(200)	not required	Chosen tariff plane of the object.
42.	timeZone	String(2)	not required	Current time zone of the object. Possible meanings: <ul style="list-style-type: none"> • 1 - One; • 2 - Two; • VR - One with reactive; • 4 - Four (Smart); • DR - Differentiated with reactive; • N - Not established.
43.	payoffMethod	String(1)	not required	Chosen pay of method of the generating consumer. Possible meanings: <ul style="list-style-type: none"> • E – kWh – Recovered electricity; • G - kW – The power plant's permissible power; • P - % - Payment percentage; • S – kWh – PP recovered electricity.
44.	objectNtr	String(20)	not required	Real estate cadaster and register number of the object of the State Enterprise Registers Center.
45.	objectNtrDate	Date	not required	Date of the Real estate cadaster and register number of the object of the State Enterprise Register Center.

No.	Attribute	type	obligation	description
46.	uniqueRoomNo	String(20)	not required	Unique room number.
47.	ntGetCoownerConsent	Boolean	required	Indication of whether the independent supplier has obtained the consent of the co-owner. Possible meanings: <ul style="list-style-type: none"> • True • False
48.	auctionDate	Date	not required	Date of acquisition of the object from the auction.
49.	anotherSupplierContractCancellation	String(4000)	not required	The field is filled in when contracts with another supplier are canceled with this notification. "Ši užklausa atšaukė objekto sutartį su [independentSupplierName] datai [contractStart]"
50.	cancelledByAnotherSupplier	Boolean	not required	The field is filled in if the object of the notification was canceled with a notification from another supplier. Possible meanings: <ul style="list-style-type: none"> • True - "Ši objekto sutartis atšaukta kito tiekėjo" • False
51.	meterDeclarations :[]			
51.1	meterNumber	String	not required	Object meter's number.
51.2	meterReadings: []			
51.2.1	scaleIdentifier	String	not required	Internal scale identifier. Possible meanings: <ul style="list-style-type: none"> • VT; • DD; • DN; • +QsumTS; • +WsumT1; • +WsumT2; • +WsumT3; • +WsumT4; • -QsumTS; • -WsumTS.

No.	Attribute	type	obligation	description
51.2.3	scaleProduct	String	not required	Internal scale product. Possible values: <ul style="list-style-type: none"> • D1 – day electricity; • D2 – evening electricity; • DD – electricity at day tariff; • MA- maximum loads; • MI – minimum loads; • N1 – night electricity; • N2 – morning electricity; • NK – electricity at night, Saturday, Sunday tariff; • RG- reactive electricity generated; • RV – reactive electricity consumption; • SV – Saturdays, Sundays, and holidays electricity; • VD – average loads; • VK - one time zone.
51.2.4	readingValue	Integer	not required	Meter's scale reading value.
51.2.5	readingValueDate	Date	not required	<ul style="list-style-type: none"> • Meter's scale reading value date. • Format: YYYY-MM-DD.
oldContractInfo: []				
52.	contractType	String(10)	required	Contract type of the current object. Possible meanings: <ul style="list-style-type: none"> • SBTS - Household customer; • SKMS - Commercial customer.
53.	consumerCode	String(20)	required	Consumer code.
oldContractInfo.object				
54.	objectNumber	String(20)	required	Object number.
55.	meterNumbers	String(200)	not required	Object meter (meters).
56.	objectAddress	String(4000)	required	Object address.
57.	contractModel	String(10)	required	Contract model of the current object. Possible meanings:

No.	Attribute	type	obligation	description
				BSS - General contract bills; 2S2S - Two contracts – Two bills.
58.	tariffPlan	String(200)	required	Tariff plan of the object.
59.	timeZone	String(2)	required	Current time zone of the object. Possible meanings: 1 - One; 2 - Two; VR - One with reactive; 4 - Four (Smart); DR - Differentiated with reactive; N - Not established.
60.	ownershipDocumentNumber	String(20)	not required	Ownership document number.
61.	ntGetCoownerConsent	Boolean	required	Indication of whether the independent supplier has obtained the consent of the co-owner. Possible meanings: True False
62.	auctionDate	Date	not required	Date of acquisition of the object from the auction.
63.	payoffMethod	String(1)	not required	Pay of method of the generating consumer. Possible meanings: E – kWh – Recovered electricity; G - kW – The power plant's permissible power; P - % - Payment percentage; S – kWh – PP recovered electricity.

7.5.1.3 Error Response structure

The following table describes the JSON structure in the event of a response error:

No.	Attribute	type	obligation	description
1.	code	number	required	Error code.
2.	text	string(4000)	required	Error message.

7.5.2 POST /gateway/notification/contract

URL	POST /gateway/notification/contract
Description	The method is for NT to transfer contract owner / contract owner and supplier / supplier changes to DH.
Parameters	<p>URL:</p> <p>The data of the JSON form request are presented in the HTTP request body (BODY) (Query JSON structure, below).</p>
Header	After decrypting the supplier authentication key, the supplier ID is used to select the data.
JSON request	<pre>{ "changeType": "string", "contractType": "string", "contractStart": "date", "consentSign": "boolean", "supplierContractNo": "string", "notes": "string", "correspondenceAddress": { "street": "string", "building": "string", "housingNo": "string", "appartement": "string", "locality": "string", "eldership": "string", "municipality": "string", "county": "string" } },</pre>

```

"ownerInfo": {
  "subjectType": "string",
  "personName": "string",
  "personSurname": "string",
  "personCode": "string",
  "birthDate": "date",
  "vatCode": "string",
  "representativeName": "string",
  "representativeSurname": "string",
  "representativeDuty": "string",
  "contacts": {
    "mobPhoneNoNetwork": "string",
    "mobPhoneNo2Network": "string",
    "mobPhoneNoInvoice": "string",
    "telPhoneNoNetwork": "string",
    "emailNetwork": "string",
    "email2Network": "string",
    "emailInvoice": "string"
  }
},
"objects": [
  {
    "objectNumber": "string",
    "tariffPlan": "string",
    "contractModel": "string",
    "timeZone": "string",
    "payoffMethod": "string",
    "objectNtr": "string",
    "objectNtrDate": "date",
    "uniqueRoomNo": "string",
    "ntGetCoownerConsent": "boolean",
    "auctionDate": "date",
    "meterDeclarations": [
      {
        "meterNumber": "string",
        "meterReadings": [

```

```

    {
      "scaleIdentifier": "string",
      "scaleProduct": "string",
      "readingValue": "integer",
      "readingValueDate": "date"
    }
  ]
}
]
}
]
}

```

Response HTTP code	HTTP status code	Reason	Description
	201	Created	Request completed successfully
	400	Bad Request	Request error. The HTTP response body provides a list of errors in JSON format. (<i>Error response of the JSON structure below</i>).
	401	Unauthorized	An attempt was made to connect to a non-public method that requires authentication, but no user credentials were provided.
	403	Forbidden	According to the access control policy, the current user does not have access to perform the requested action.
	404	Not Found	Either there is no API method associated with the request URL path, or the request contains one or more parameters that did not return the data.
JSON response	<pre> { "notificationId": "integer" } </pre>		
JSON error response	<pre> { "errorMessages": [{ "code": "integer", "text": "string" }] } </pre>		

```

    }
  ]
}

```

Rules	No.	Rule description	*SK	**S TK	***NT K	Error code	Error message	Attributes
*SK - the relevant rule for change of owner **STK - the relevant rule for change of owner and supplier ***NTK – the relevant rule for change of supplier								
	0.	If an attribute has defined possible values, the value index can be specified by specifying the value of the attribute in the request. Indices of all possible values start from 0.	+	+	+	-	If an attribute has defined possible values, the value index can be specified by specifying the value of the attribute in the request. Indices of all possible values start from 0.	-
	1.	Time-limited objects cannot be changed if they are expired. Ex.: If the time-limited object expiry date is 12-20 and the current date is 12-20 then 12-20=12-20 → the system displays error message; Ex.: If the time-limited object expiry date is 12-20 and the current date is 12-22 then 12-20<12-22 → the system displays error message; Ex.: If the time-limited object expiry date is 12-21 and the current date is 12-20 then 12-21>12-20 → there is no error.	+	+	-	5	Change not possible. Time-limited objects: [objectNumber (if there is more than one object, objects must be separated by the semicolon)] are expired.	object.time_limited_object_valid_to, object.object_number, object.object_id, objectNumber
	2.	Submitted object cannot have the same / matching meters numbers.	+	+	+	6	Change not possible. Objects: [objectNumber (if there is more than one object, objects must be separated by the semicolon)] have the same / matching meter number.	object_meter.meter_number, object_meter.valid_from, object_meter.valid_to,

								object.object_number, object.object_id, objectNumber
3.	The attribute [ObjectNumber] is mandatory.	+	+	+	-	-		objectNumber
4.	The meaning of the [ObjectNumber] notification cannot be repeated.	+	+	+	7		The object: [objectNumber (if there is more than one object, objects must be separated by the semicolon)] is repeating.	objectNumber
5.	Must be specified valid object.	+	+	+	8		The object: [objectNumber (if there is more than one object, objects must be separated by the semicolon)] is not valid.	objectNumber
6.	If changeType=SK , then the object must belong to a valid supplier contract that provides the notification.	+	-	-	9		The object: [objectNumber (if there is more than one object, objects must be separated by the semicolon)] does not belong to a valid supplier contract.	objectNumber, independentSupplierId, independent_supplier_objects.valid_from independent_supplier_objects.valid_to contract.conclusion_date
7.	The attribute [subjectType] meaning must be: - FAS or - JAS .	+	+	+	-	-		subjectType
8.	The attribute [contractType] meaning must be: - SBTS or	+	+	+	-	-		contractType

	- SKMS.						
9.	If the attribute [subjectType] = JAS , the attribute [contractType] meaning must be equal to SKMS .	+	+	+	10	If the contract owner / tenant person type is "Juridical", the contract type must be "SKMS"	subjectType, contractType
9.1.	If the attribute [changeType] = NTK , the values of the attribute [contractType] and [subjectType] must match the current contract type of the object and the person type of the owner.	-	-	+	129	The contract type and the contract owner's person type must match the current contract type and the contract owner type.	contractType, subjectType, changeType
10.	If changeType=SK/STK , then the attribute [contractStart] can be equal to the current date or later than current. Ex.: If the current date is 2021-02-08 , then [contractStart] start date can be any date inclusive from 2021-02-08 to X date in the future.	+	+	-	11	Date of the contract start [contractStart] can be equal to the current date or later then current.	contractStart, objectNumber, changeType
10.1.	If changeType=NTK , then the attribute [contractStart] must be equal to the first day of the month.	-	-	+	111	Date of the contract start [contractStart] must be equal to the first day of the month.	contractStart, objectNumber, changeType
12.	If changeType=NTK , it is checked whether the date of entry into force of the contract is given correctly: Notifications of the concluded contract must be submitted by the day of the month specified in the configuration, and the contract may enter into force at the earliest from the first day of the following month. Ex.: configuration date is 18 d. current date 2021-09-17 this is the earliest contract that can be concluded on October 1.	-	-	+	113	The effective date of the contract must not be less than [date] .	contractStart, objectNumber, changeType

	current date 2021-09-20 this is the earliest contract that can be concluded on November 1.						
13.	If changeType=NTK : when submitting a new supplier change notification, the system must be checked for the presence of supplier change notification with a status not Canceled and not Error.	-	-	+	116	Due to possible duplication of information, such a notification to object [objectNumber] is not possible. Please try after 30 minutes.	contractStart, objectNumber, changeType
14.	If changeType=NTK , then a change of supplier notice shall not be permitted if a change of owner and supplier notice is in progress. It should not be allowed only if the object number and the date of contract start force of the contract coincide in the notifications.	-	-	+	117	For object [object number (if more than one is separated by a semicolon)] , a change of supplier is already in progress with the owner and supplier change request	contractStart, objectNumber, changeType
15.	In the context of the object, one irrevocable / infallible change of owner (SK) / owner and supplier (STK) request is possible for the same contract entry date. Another request can be submitted from the day following the entry into force of the latest request agreement found. <ul style="list-style-type: none"> • If the object X does not have the notification of the owner / owner and supplier in the system with the status "Įvykdytas" / "Vykdomas" / "Pateiktas" / "Išsiųstas", then: • The contract start date for the new notification must be chosen from the current day to X date in the future. <ul style="list-style-type: none"> • ex.: current date 2021-05-12, then the notification date can 	+	+	-	12	The request to change owner / owner and supplier for objects [objectNumber (if more than one is separated by a semicolon)] has already been submitted.	objectNumber, contract_object_change_notification.object_number, contractStart, contract_object_change_notification.contract_start, changeType=SK, contract_change_notification.change_type=SK, contract_change_status.status=Priimtas

		<p>be 2021-05-12 to X date in the future;</p> <ul style="list-style-type: none"> • If the object X has the notification of the owner / owner and supplier in the system with the status "Įvykdytas" / "Vykdomas" / "Išsiųstas" / "Pateiktas" , then: • The latest date of entry into force of the contract from the notification must be checked AND • the notification may be submitted from the date of entry into force of the latest notification contract found from the following day to X date in the future. <ul style="list-style-type: none"> • ex.: current 2021-05-12, found a message for the date 2021-05-14, and a message for the date 2021-05-21, this can provide dates from 2021-05-22 to X date in the future; • ex.: current 2021-05-12, found a message for the date 2021-05-14 and a message for the date 2021-06-01, this message can provide dates from 2021-06-02 to X date in the future. 									
16.		The attribute [contractStart] format must be: yyyy-mm-dd. yyyy - year; mm - month; dd - day.	+	+	+	-	-				contractStart

17.	Mandatory attributes are: <ul style="list-style-type: none"> • [subjectType] and • [contractType] and • [contractStart]. 	+	+	+	-	-	subjectType, contractType, contractStart
18.	If the attribute [changeType]=STK/NTK then mandatory attribute is: - [supplierContractNo]	-	+	+	14	"Contract No." is mandatory.	supplierContractNo
19.	The [contractModel] attribute must be: - BSS or - 2S2S .	+	+	+	-	-	contractModel, changeType
20.	If the attribute [contractType]=SBTS then meaning of the [contractModel] attribute must be equal to BSS .	+	+	+	16	If the contract type is equal to "SBTS" then the contract model must be "BSS".	contractType, contractModel
21.	If the attribute [changeType]=NTK , [contractType]=SBTS , It is possible to change the tariff plan (not null and does not match the current one) and/or time zone (not null and does not match the current one) of the object, if the possible date of changing the tariff plan and/or time zone is earlier than or equal to the date of "Contract start". If the attribute [changeType]=NTK , [contractType]=SKMS , It is possible to change the time zone (not null and does not match the current one) of the object, if the possible date of changing the tariff plan is earlier than or equal to the date of "Contract start".	-	-	+	131	Change not possible. The object: [objectNumber] possible tariff plan change [date] date is later than the date of contract start.	tariffPlan, changeType, contractType, objectnumber

22.	If changeType=STK/NTK , then the object may be included in no more than one contract with the supplier, which indicates the same date of entry into force of the contract.	-	+	-	108	An information of the conclusion of the contract with [independent_supplier.name] since [independent_supplier_object.valid_from] has already been submitted to the object [objectNumber] .	changeType, objectNumber, independent_supplier_object
23.	If the attribute [subjectType]=FAS then the mandatory attributes are: - [personName] and - [personSurname] and - [personCode] or [birthDate].	+	+	+	18	If the person type of the contract owner / tenant is "Physical", the "Name" and "Surname" and "Personal identification code" or "Date of birth" are mandatory.	personName, personSurname, personCode, birthDate, subjectType
24.	If the attribute [subjectType]=JAS then the mandatory attributes are: - [personName] and - [personCode].	+	+	+	19	If the person type of the contract owner / tenant is "Juridical", then "Company Name" and "Company Code" are mandatory.	personName, personCode, subjectType
25.	The attribute [birthDate] format must be: yyyy-mm-dd. yyyy - year; mm - month; dd - day.	+	+	+	-	-	birthDate
26.	If changeType=SK/STK/NTK and if the attribute [contractType] = SBTS , then must be at least one contact attribute: <ul style="list-style-type: none"> • [mobPhoneNoNetwork] or • [telPhoneNoNetwork] or • [emailNetwork]. 	+	+	+	20	If the contract type is "SBTS", it is mandatory to specify at least one attribute for network work: "Mobile phone no." or "Phone no." or "Email address".	mobPhoneNoNetwork , emailNetwork, contractType, changeType
27.	If changeType=SK/STK/NTK and attribute [contractType] = SKMS then must be at least one contact attribute:	+	+	+	21	If the contract type is "SKMS", it is mandatory to specify one of the contacts for network work: "Mobile phone no." or "Email	mobPhoneNoNetwork , emailNetwork, mobPhoneNoInvoice, emailInvoice,

	<p>- [mobPhoneNoNetwork] or - [emailNetwork].</p> <p>and at least one contact attribute of the bills from:</p> <p>- [mobPhoneNoInvoice] or - [emailInvoice].</p>					Address" and one of the contact for accounts: "Mobile Phone no." or "Email Address".	contractType, changeType
28.	<p>The format of the attributes [mobPhoneNoNetwork], [mobPhoneNo2Network], [mobPhoneNoInvoice] must be : +3706XXXXXXX, X - an integer (0 must be included) The format of the attribute [telPhoneNoNetwork] must be : +370XXXXXXX, X - an integer (0 must be included). The next number after +370 cannot be 6.</p>	+	+	+	22	Mob. tel. No., mob. tel. No. (optional) and phone no. incorrect format.	mobPhoneNoNetwork , mobPhoneNo2Network, telPhoneNoNetwork, mobPhoneNoInvoice
29.	<p>The format of the attributes [emailNetwork], [email2Network], [emailInvoice] must be [text][@][text][.domain], letters in the text must be Latin.</p> <p>Can be at most 49 characters up to @ symbol and cannot begin/end with a dot or special character.</p>	+	+	+	23	An email address, optional email address and invoice email address incorrect format.	emailNetwork, email2Network, emailInvoice
30.	<p>If changeType=SK/STK, then in the context of an object, one irrevocable / infallible change of owner / owner and supplier change request is possible for the same owner. The current contract owner cannot match the newly submitted owner.</p>	+	+	-	24	The owner [personName personSurname (personSurname is displayed if subjectType = FAS)] has already been queried or the owner coincides with the owner of the current contract.	subjectType, personSurname, personName, personCode, birthDate, contractStart

30.1.	If changeType = NTK , then in the context of the object, the provided owner must match the owner of the current contract.	-	-	+	121	The owner [personName personSurname (personSurname is displayed if subjectType = FAS)] does not match the owner of the current contract. Request a change of owner and supplier.	changeType, personCode, personName, personSurname, birthDate	
31.	If the attribute [contractType] = SBTS , then the meaning of the [tariffPlan] attribute must be: - Namai or - Namai plius or - Standartinis or - Išmanusis or - Vidutinė įtampa.	+	+	+	27	If the contract type is SBTS, then the tariff plan must be "Namai" / "Namai plius" / "Standartinis" / "Išmanusis" / "Vidutinė įtampa".	tariffPlan, contractType	
32.	If the attribute [changeType]=SK/STK and [contractType] = SBTS , then the mandatory attributes are: - [tariffPlan] and - [timeZone].	+	+	-	28	If the contract type is "SBTS", it is mandatory to indicate "Tariff Plan" and "Time Zone".	tariffPlan, timeZone, contractType	
32.1.	If the attribute [changeType]=NTK , [contractType] = SBTS and if at least one attribute is specified: • [tariffPlan] or • [timeZone] Then both must be specified.	-	-	+	122	If the contract type is "SBTS" and "Tariff Plan" or "Time Zone" is specified, then both must be specified.	tariffPlan, timeZone, contractType	
33.	If the attribute [contractType] = SBTS and attribute [tariffPlan] = Išmanusis , then the	+	+	+	29	If the contract type is SBTS and the tariff plan is "Išmanusis", then the time zone must be "4 (Smart)".	timeZone, contractType, tariffPlan	

	attribute [timeZone] meaning must be: <ul style="list-style-type: none"> • 4. 						
34.	If the attribute [contractType] = SBTS and attribute [tariffPlan] = Namai / Namai plius / Standartinis / Vidutiné jtampa , then the attribute [timeZone] meaning must be: <ul style="list-style-type: none"> - 1 or - 2. 	+	+	+	30	If the contract type is SBTS and the tariff plan is "Namai" or "Namai plius" or "Standartinis" or "Vidutiné jtampa", then the time zone must be One or Two.	timeZone, contractType, tariffPlan
35.	The meaning of the [ntGetCoownerConsent] attribute must be: <ul style="list-style-type: none"> - True or - False. 	+	+	-	-	-	ntGetCoownerConsent
36.	The format of the [auctionDate] attribute must be: yyyy-mm-dd, yyyy - years, mm - month, dd - day.	+	+	-	-	-	auctionDate
37.	The format of the [ObjectNtrDate] attribute must be: yyyy-mm-dd , yyyy - years, mm - month, dd - day.	+	+	-	-	-	objectNtrDate
38.	The meaning of the [payoffMethod] attribute must be: <ul style="list-style-type: none"> - E or - G or - P or - S 	+	+	+	-	-	payoffMethod

39.	If the attribute [objectNtr] is filled then the [objectNtrDate] attribute is mandatory.	+	+	-	31	If the Real estate cadaster and register of the State Enterprise Centre of Registers object is filled in, the Real estate cadaster and register date of the State Enterprise Centre of Registers object must be indicated.	objectNtr, objectNtrDate
40.	The meaning of the [consentSign] must be: - True or - False .	+	+	+	-	-	consentSign
41.	If the attribute [consentSign] = False , then the modification must be disabled.	+	+	+	32	It is necessary to confirm that the data provided is correct.	consentSign
42.	Upon successful creation of a change of owner / owner and supplier / supplier request, the status of the request becomes "Submitted".	+	+	+	-	-	contract_change_stat us.status, contract_change_stat us.status_date
43.	Meaning of the mandatory attribute [changeType] must be: <ul style="list-style-type: none"> • SK or • STK or • NTK 	+	+	+	-	-	changeType
44.	The involved party will be identified by the authentication key.	+	+	+	1003	The involved party cannot be found in the system or involved party is not active.	independent_supplier .id, contract_change_noti fication.independent_ supplier_id
45.	The [contractModel] attribute is mandatory.	+	+	+	-	-	contractModel, changeType
46.	The attribute [contractModel] must match for all objects.	+	+	+	148	The contract model must match for all objects.	objectNumber, contractModel

47.	If attribute changeType=NTK , then the attributes must not be specified: <ul style="list-style-type: none"> • objectNtr • objectNtrDate • auctionDate • ntGetCoownerConsent • uniqueRoomNo 	-	-	+	130	If the change type is "Supplier change", the attributes must not be specified: "Object ntr", "Object ntr date", "Auction date", "NT get coowner consent", "Unique room No.".	objectNtr, objectNtrDate, auctionDate, ntGetCoownerConsent, uniqueRoomNo, changeType
48.	If the attribute [contractType] = SBTS , must be specified valid [tariffPlan].	+	+	+	35	There is no tariff plan [tariffPlan (if there is more than one object, objects must be separated by the semicolon)].	tariffPlan, tariff_plan_category.tariff_plan_category_id, contract_object_change_notification.tariff_plan_category_id, contractType
49.	The value of attribute [birthDate] cannot be later than the current date.	+	+	+	37	A birth date cannot be later than the current date.	birthdate
50.	If the attribute [objectNtrDate] is filled then the [objectNtr] attribute is mandatory.	+	+	+	38	If date of the Real estate cadaster and register number of the object of the State Enterprise Register is filled, the Real estate cadaster and register number of the object of the State Enterprise Registers Center must be included.	objectNtr, objectNtrDate
52.	If changeType=SK/STK/NTK and If the attribute [contractType]= SBTS then attributes [mobPhoneNoInvoice] and [emailInvoice] cannot be filled.	+	+	+	41	If the contract type "SBTS", then invoice mob. tel. No. and invoice email address cannot be filled.	contractType, mobPhoneNoInvoice, emailInvoice
53.	If the attribute [changeType]=SK/STK, then the attribute [payoffMethod] cannot be field if consumer type is not generating consumer [generatingObjectType is not G] and [contractType is not SBTS].	+	+	-	42	Generating consumer payoff method can be field, if consumer type is GV and contract type - SBTS.	payoffMethod, generatingObjectType

54.	If the attribute [changeType]=NTK, then the attribute [payoffMethod] cannot be field if consumer type is not generating consumer [generatingObjectType is not G] or field if consumer is not remote generating consumer [generatingObjectType is not N] and [contractType is not SBTS].	-	-	+	210	Generating consumer payoff method can be field, if consumer type is GV or NGV and contract type - SBTS.	payoffMethod, generatingObjectType
56.	The attribute [timeZone] must be: <ul style="list-style-type: none"> • 1; • 2; • VR; • 4; • DR. 	+	+	+	-	-	timeZone
57.	All objects of the notification must belong to the same contract.	+	+	+	43	Change not possible. Different contracts for submitted objects.	objectNumber, consumerCode
58.	If the attribute [subjectType] = FAS, then the attribute [personCode] must be 11 digits. If the attribute [subjectType] = JAS, then the attribute [personCode] must be 9 digits.	+	+	+	44	The personal code must consist of 11 digits, the company code - 9 digits.	subjectType, personCode
59.	If the attribute [subjectType] = JAS, then the attributes [birthDate] and [personSurname] cannot be specified.	+	+	+	45	If the contract owner / tenant person type is "Juridical", the birth date and surname cannot be specified.	subjectType, birthDate, personSurname
60.	If the attribute [subjectType] = FAS, then the attribute [personName] must be up to 50 symbols.	+	+	+	46	If the contract owner / tenant person type is "Individual", the name must be up to 50 symbols.	subjectType, personName
61.	If the attribute [contractType] = SKMS and at least one of the attributes [representativeName],	+	+	+	141	If the contract type is "SKMS" and at least one attribute of the representative is specified, all	contractType, representativeName,

	[representativeSurname], [representativeDuty] is specified, all three attributes must be filled in.					three attributes must be indicated: "Representative name", "Representative surname", "Representative duty".	representativeSurname, representativeDuty
62.	If the attribute contractType] = SBTS, then the attributes [representativeName], [representativeSurname] and [representativeDuty] cannot be specified.	+	+	+	147	If the contract type is "SBTS", the name, surname and the duty of the representative cannot be specified.	contractType, representativeName, representativeSurname, representativeDuty
63.	If the attribute [contractType] = SBTS and the current tariff plan of object is "Vidutinė įtampa", then the new [tariffPlan] must be "Vidutinė įtampa".	+	+	+	48	If the contract type is "SBTS" and the current tariff plan of object [objectNumber] is "Vidutinė įtampa", then the new tariff plan must be "Vidutinė įtampa"	tariffPlan, contractType
64.	If the attribute [contractType]= SBTS , then object tariffPlan=Vidutinė įtampa cannot be specified, if current tariffPlan of object is not "Vidutinė įtampa".	+	+	+	49	If the contract type "SBTS" and the current tariff plan of object [objectNumber] is not "Vidutinė įtampa", then the new tariff plan can be "Namai" / "Namai plius" / "Standartinis" / "Išmanusis".	tariffPlan, contractType
65.	If the attribute [changeType]=SK/STK, [contractType]=SKMS, then attribute [timeZone] is required.	+	+	-	123	If the contract type is "SKMS" it is mandatory to indicate "Time zone".	contractType, changeType, timeZone
66.	If the object contractType=SKMS and PermittablePowerConsumption <=30 kw, the attribute's [timeZone] possible values: <ul style="list-style-type: none"> • 1 or; • 2. 	+	+	+	124	If the contract type is "SKMS" of the object: [objectNumber] and PermittablePowerConsumption <= 30 kw, then the time zone must be "One" or "Two".	contractType, changeType, timeZone, power
67.	If the object contractType=SKMS and PermittablePowerConsumption > 30 kw, the attribute's [newTimeZone] possible values:	+	+	+	125	If the contract type is "SKMS" of the object: [objectNumber] and permissible power consumption > 30 kw, then the time zone must	contractType, changeType, timeZone, power

		<ul style="list-style-type: none"> VR or; DR. 					be "One with reactive" or "Differentiated with reactive ones".	
68.	<p>If the attribute [changeType] = SK / STK, [contractType] = SKMS and the object failed to determine the valid usable power, the change is not possible.</p> <p>If the attribute [changeType] = NTK, [contractType] = SKMS and the attribute [timeZone] is specified, then if the object failed to determine the valid usable power, then the change is not possible.</p>	+	+	+	127	Failed to set usable power for the object [objectNumber].	changeType, contractType, timeZone	
69.	If the contractType=SKMS , then the attribute [tariffPlan] cannot be specified.	+	+	+	126	If the contract type is "SKMS", then the tariff plan cannot be specified.	contractType, changeType, tariffPlan	
70.	<p>If the changeType=SK/STK, then the attribute [ntGetCoownerConsent] is required.</p> <p>The meaning of the [ntGetCoownerConsent] attribute must be:</p> <ul style="list-style-type: none"> True or False. 	+	+	-	140	The attribute "NT get coowner consent" is required.	ntGetCoownerConsent	
71.	<p>Attribute [changeType] is required.</p> <p>Values of attribute [changeType]:</p> <ul style="list-style-type: none"> SK STK NTK 	+	+	+	-	-	changeType	
72.	If the attribute [changeType] = NTK and [contractType] = SBTS and the object is a generating user = G (GV) and the attribute [payoffMethod] (not null and	-	-	+	134	Change not possible. Object: [objectNumber] possible generating capacity user payoff method change [date] date is	changeType, contractType, payoffMethod	

		does not match the current one) is specified, the payoff method can be changed if the date of the change in the GV payoff method is earlier or equal to the date of "Contract start".					later than the date of contract start.	
	73.	If changeType=SK/STK and attribute [contractType]=SKMS then the attribute [vatCode] can be filled.	+	+	+	150	The VAT code can be filled, when change type is "SK" or "STK" and contract type is "SKMS".	changeType, contractType, vatCode
	75.	If changeType=STK , then the attribute [contractStart] can be equal to the current date or later, but not later than the last day of the following month. Ex.: If the current date is 2023-05-11, then [contractStart] start date can be any date inclusive from 2023-05-11 to 2023-06-31 date in the following month.	-	+	-	118	Date of the contract start [contractStart] can be equal to the current date or later, but not later than [the last day of the following month].	contractStart, objectNumber, changeType
	76.	If the attribute generatingObjectType is G (generating consumer) or generatingObjectType is N (remote generating consumer), then fields must not be specified: <ul style="list-style-type: none"> • meterNumber • scaleIdentifier; • scaleProduct; • readingValue; • readingValueDate 	+	+	-	152	If consumer type is generating user or remote generating consumer, then attributes "Meter number", "Scale identifier", "Scale product", "Reading value", "Reading value date" must not be specified.	generatingObjectType , meterNumber, scaleIdentifier, scaleProduct, reading Value, readingValueD ate

77.	Reading values can only be filled for valid meters and scales.	+	+	-	153	The object [objectNumber] meter(s) and/or meter scale(s) does not exist or is no longer valid. Please check provided data.	meterNumber, scaleIdentifier, scaleProduct
78.	It is mandatory to fill the scales of all meters in the object at the same time.	+	+	-	154	All meters with all scales of the [objectNumber] object must be filled.	meterNumber, scaleIdentifier, scaleProduct, readingValue, readingValueDate
79.	Meter scale and scale product cannot be repeated for the same object.	+	+	-	155	The object [objectNumber] meter [meterNumber] scale and scale product combination cannot be repeated.	meterNumber, scaleIdentifier, scaleProduct
80.	If at least one of the reading statement attributes [meterNumber] , [scaleIdentifier] , [scaleProduct] , [readingValue] , [readingValueDate] is specified, then all attributes must be filled in.	+	+	-	156	If at least one attribute of the reading statement is specified, then all attributes must be in indicated: "Meter number", "Scale identifier", "Scale product", "Reading value", "Reading value date".	meterNumber, scaleIdentifier, scaleProduct, readingValue, readingValueDate
81.	Attribute [readingValueDate] can be equal to the current date or earlier then current. Ex.: If current date is 2023-11-27, then [readingValueDate] can be any date inclusive from 2023-11-27 to X date in the past.	+	+	-	157	The reading date [readingValueDate] must be equal to the current date or earlier than current.	readingValueDate
82.	The attribute [readingValueDate] must match for all object's scales.	+	+	-	158	The reading date must match for all object's scales.	readingValueDate
83.	The maximum number of characters in the reading readingValue is checked.	+	+	-	159	Incorrect number of digits in "Reading value" field. Please check maximum number of digits in scale.	readingValue

	84.	<p>If contractType=NTK, then fields must not be specified:</p> <ul style="list-style-type: none"> • meterNumber • scaleIdentifier; • scaleProduct; • readingValue; • readingValueDate 	-	-	+	160	<p>If contract type is NTK, then attributes "Meter number", "Scale identifier", "Scale product", "Reading value", "Reading value date" must not be specified.</p>	<p>changeType, meterNumber, scaleIdentifier, scaleProduct, readingValue, readingValueDate</p>
	85.	<p>The attribute [meterNumber] shall not be repeated in the message for the same object.</p>	+	+	-	164	<p>The meter numbers of the object [objectNumber] cannot be repeated.</p>	<p>objectNumber, meterNumber</p>
	86.	<p>If the attribute [contractType]=SKMS and attribute [changeType]=NTK and there is specified at least one contact for network work, then attributes cannot be filled:</p> <ul style="list-style-type: none"> • mobPhoneNoNetwork • emailNetwork 	-	-	+	161	<p>Contact cannot be specified. One of the contacts for network work: "Mob. phone no." and / or "Email Address" is submitted.</p>	<p>mobPhoneNoNetwork , emailNetwork</p>
	87.	<p>If the attribute [contractType]=SKMS and attribute [changeType]=NTK there is specified at least one contact for accounts, then attributes cannot be filled:</p> <ul style="list-style-type: none"> • mobPhoneNoInvoice • emailInvoice 	-	-	+	162	<p>Contact cannot be specified. One of the contacts for accounts: "Mob. phone no." and / or "Email Address" is submitted.</p>	<p>mobPhoneNoNetwork , emailNetwork</p>

7.5.2.1 JSON Request structure

The table below describes the structure of the JSON request:

No.	Attribute	type	obligation	description
1.	changeType	String(10)	required	Change type. Possible meanings: <ul style="list-style-type: none"> • SK - Owner change; • STK - Owner and supplier change.
2.	contractType	String(10)	required	Contract type. Possible meanings: <ul style="list-style-type: none"> • SBTS - Household customer; • SKMS - Commercial customer.
3.	contractStart	Date	required	Start date of entry into force of the contract at an independent supplier.
4.	consentSign	Boolean	required	Indication of whether the data provided by the contract owner / owner and supplier are correct. Possible meanings: <ul style="list-style-type: none"> - True; - False.
5.	supplierContractNo	String(30)	not required	Contract number.
6.	notes	String(4000)	not required	Notes.
correspondenceAddress				
7.	street	String(200)	not required	Street.
8.	building	String(100)	not required	Building.
9.	housingNo	String(100)	not required	Housing.
10.	apartment	String(20)	not required	Flat.
11.	locality	String(200)	not required	Town / Village.
12.	eldership	String(200)	not required	Eldership.

No.	Attribute	type	obligation	description
13.	municipality	String(200)	not required	Municipality.
14.	county	String(200)	not required	County.
ownerInfo				
15.	subjectType	String(10)	required	Contract owner / tenant person type. Possible meaning: FAS - individual; JAS - Juridical.
16.	personName	String(200)	required	Contract owner / tenant / company name.
17.	personSurname	String(50)	not required	Contract owner / tenant surname.
18.	personCode	String(20)	not required	Contract owner / tenant person / company code
19.	birthDate	Date	not required	Contract owner / tenant birth date.
20.	vatCode	String(15)	not required	Contract owner / tenant VAT code.
ownerInfo.contacts				
21.	mobPhoneNoNetwork	String(12)	not required	Mobile phone number for networks. Contact details for information on network work (accounting maintenance, electrical disconnections and faults).
22.	mobPhoneNo2Network	String(12)	not required	Mobile phone number 2 for networks. Contact details for information on network work (accounting maintenance, electrical disconnections and faults).
23.	mobPhoneNoInvoice	String(12)	not required	Mobile phone number for bills. Contact details for informing about formed invoices and provided services.
24.	telPhoneNoNetwork	String(12)	not required	Phone number for networks. Contact details for information on network work (accounting maintenance, electrical disconnections and faults).

No.	Attribute	type	obligation	description
25.	emailNetwork	String(49)	not required	An email address for networks. Contact details for information on network work (accounting maintenance, electrical disconnections and faults).
26.	email2Network	String(49)	not required	An email address 2 for networks. Contact details for information on network work (accounting maintenance, electrical disconnections and faults).
27.	emailInvoice	String(100)	not required	An email address 2 for networks. Contact details for information on network work (accounting maintenance, electrical disconnections and faults).
objects: []				
28.	objectNumber	String(20)	required	Object number.
29.	tariffPlan	String(200)	not required	Chosen tariff plan of the SBTS contract
30.	contractModel	String(10)	required	Contract model of the current object. Possible meanings: BSS - General contract bills; 2S2S - Two contracts – Two bills.
31.	timeZone	String(2)	not required	Current time zone of the object. Possible meanings: 1 - One; 2 - Two; VR - One with reactive; 4 - Four (Smart); DR - Differentiated with reactive.
32.	payoffMethod	String(1)	not required	Chosen pay of method of the generating consumer. Possible meanings: <ul style="list-style-type: none"> • E – kWh – Recovered electricity; • G - kW – The power plant's permissible power; • P - % - Payment percentage; • S – kWh – PP recovered electricity.

No.	Attribute	type	obligation	description
33.	objectNtr	String(20)	not required	Real estate cadaster and register number of the object of the State Enterprise Registers Center.
34.	objectNtrDate	Date	not required	Date of the Real estate cadaster and register number of the object of the State Enterprise Register Center.
35.	uniqueRoomNo	String(20)	not required	Unique room number.
36.	ntGetCoownerConsent	Boolean	required	The feature or independent supplier has received the consent of the co-owners. Possible meanings: <ul style="list-style-type: none"> • True; • False
37.	auctionDate	Date	not required	Date of acquisition of the object from the auction.
38.	meterDeclarations: []			
38.1	meterNumber	String	not required	Object meter's number.
38.2	meterReadings: []			
38.2.1	scaleIdentifier	String	not required	Internal scale identifier. Possible meanings: <ul style="list-style-type: none"> • VT; • DD; • DN; • +QsumTS; • +WsumT1; • +WsumT2; • +WsumT3; • +WsumT4; • -QsumTS; • -WsumTS.
38.2.2	scaleProduct	String	not required	Internal scale product. Possible values: <ul style="list-style-type: none"> • D1 – day electricity; • D2 – evening electricity;

No.	Attribute	type	obligation	description
				<ul style="list-style-type: none"> • DD – electricity at day tariff; • MA- maximum loads; • MI – minimum loads; • N1 – night electricity; • N2 – morning electricity; • NK – electricity at night, Saturday, Sunday tariff; • RG- reactive electricity generated; • RV – reactive electricity consumption; • SV – Saturdays, Sundays, and holidays electricity; • VD – average loads; • VK - one time zone.
38.2.3	readingValue	Integer	not required	Meter's scale reading value.
38.2.4	readingValueDate	Date	not required	<ul style="list-style-type: none"> • Meter's scale reading value date. • Format: YYYY-MM-DD.

7.5.2.2 JSON Response structure

The following table describes the JSON structure in the event of a response:

No.	Attribute	type	obligation	description
1.	notificationId	Integer	required	Notification ID.

7.5.2.3 Error Response structure

The following table describes the JSON structure in the event of a response error:

No.	Attribute	type	obligation	description
1.	code	number	required	Error code.
2.	text	string(4000)	required	Error message.

7.5.3 POST /gateway/notification/{notificationId}/contract/cancel

URI	POST /gateway/notification/{notificationId}/contract/cancel		
Description	The method is to cancel the change of contract owner / contract owner and supplier / supplier notification.		
Parameters	URL: <i>notificationId</i> - message identifier. Mandatory.		
Header	After encrypting the supplier authentication key, the supplier ID is used to verify that the supplier is revoking its message.		
Request	POST request does not have the BODY part.		
Response HTTP code	HTTP status code	Reason	Description
	201	Created	Request completed successfully.

	400	Bad Request	Request error. The HTTP response body provides a list of errors in JSON format. (<i>Error response of the JSON structure below</i>).		
	401	Unauthorized	An attempt was made to connect to a non-public method that requires authentication, but no user credentials were provided.		
	403	Forbidden	According to the access control policy, the current user does not have access to perform the requested action.		
	404	Not Found	Either there is no API method associated with the request URL path, or the request contains one or more parameters that did not return the data.		
Response					
JSON error response	<pre> { "errorMessages": [{ "code": 0, "text": "string" }] } </pre>				
Rules	No.	Rule description	Error code	Error message	Attributes
	0.	If an attribute has defined possible values, the value index can be specified by specifying the value of the attribute in the request. Indices of all possible values start from 0.	-	-	All attributes with specified values.
	1.	The request can be canceled: only one time; when the notification state is "Pateiktas"; when the cancellation deadline has not passed (Initial value - 1 hour).	50	According to the given parameters, the message to be canceled could not be found / the cancellation deadline has expired / the message has already been canceled.	contract_change_status.status, contract_change_status.status.date

	2.	Upon successful cancellation of the owner / owner and supplier change request, the status of the request becomes "Atšauktas".	-	-	contract_change_status.status, contract_change_status.status. date
--	----	---	---	---	--

7.5.3.1 Error Response structure

The following table describes the JSON structure in the event of a response error:

No.	Attribute	type	obligation	description
1.	code	number	required	Error code.
2.	text	string(4000)	required	Error message.

7.6 Notification contract termination controller

7.6.1 POST /gateway/notification/v2/contract/termination/list

URL	POST /gateway/notification/v2/contract/termination/list?first={integer}&count={integer}&sortOrder={ASC/DSC}
Description	Method to obtain information of the contract termination.
Parameters	<p>URL parameters:</p> <ul style="list-style-type: none"> first - the index of the notification, which must be the first in the return list (starting from 0). Optional. The default value is 0. count - the number of notification rows in the return list. Optional. The default value is 30.

	<ul style="list-style-type: none"> • sort - possible values ASC, DSC. <p>The data of the JSON form request are presented in the HTTP request body (BODY) (Query JSON structure, below).</p>		
Header	After decrypting the supplier authentication key, the supplier ID is used to select the data.		
JSON request	<pre> { "personCode": "string", "objectNumber": "string", "notificationId": "number", "contractTerminationDateFrom": "date", "contractTerminationDateTo": "date", "submittedDateFrom": "datetime", "submittedDateTo": "datetime", "latestStatuses": ["string"], "contractTerminationReason": "string", "userNameSearch": "string", "declared": "boolean" } </pre>		
Response HTTP code	HTTP status code	Reason	Description
	200	OK	Request completed successfully
	204	No Content	No data found according to the given parameters.
	400	Bad Request	Request error. The HTTP response body provides a list of errors in JSON format. (<i>Error response of the JSON structure below</i>).
	401	Unauthorized	An attempt was made to connect to a non-public method that requires authentication, but no user credentials were provided.
	403	Forbidden	According to the access control policy, the current user does not have access to perform the requested action.

	404	Not Found	Either there is no API method associated with the request URL path, or the request contains one or more parameters that did not return the data.
JSON response	<pre>[{ "notificationId": "integer", "contractTerminationDate": "date", "contractTerminationReason": "string", "userName": "string", "submittedDate": "datetime", "latestStatus": "string", "errorType": "string", "objects": [{ "personName": "string", "personSurname": "string", "personCode": "string", "consumerCode": "string", "objectNumber": "string", "objectAddress": "string", "contractType": "string", "contractModel": "string", "contractStart": "date", "coowner": "boolean", "coownerConsentDate": "date", "meterNumbers": ["string"], "meterDeclarations": [{ "meterNumber": "string", "meterReadings": [{ "scaleIdentifier": "string", "scaleProduct": "string", "readingValue": "integer",</pre>		

	<pre> "readingValueDate": "date" }] } }, "contractTerminationNotificationStatus": [{ "status": "string", "statusDate": "datetime" }] }] </pre>				
JSON error response	<pre> { "errorMessages": [{ "code": "integer", "text": "string" }] } </pre>				
Rules	No.	Rule description	Error code	Error message	Attributes
	0.	If an attribute has defined possible values, the value index can be specified by specifying the value of the attribute in the request. Indices of all possible values start from 0.	-	-	All attributes with specified values.
	1.	No data found according to the given parameters.	HTTP 204	-	-

	2.	The date from cannot be later than the date to. Equal can be.	1002	Date from cannot be later than date to.	dateFrom, dateTo
	3.	The value of the count parameter must be less or equal to 10000.	1007	The value of the count parameter must be less or equal to 10000.	Count
	4.	Submitted date cannot be later than the current date but can be equal.	1010	Submitted date cannot be later than the current date.	submittedDateFrom, submittedDateTo

7.6.1.1 JSON Request structure

The table below describes the structure of the JSON response:

No.	Attribute	type	obligation	description
1.	personCode	String(20)	not required	Person / company code.
2.	objectNumber	String(20)	not required	Object number.
3.	notificationId	Integer	not required	Notification ID.
4.	contractTerminationDateFrom	Date	not required	Contract termination date from.
5.	contractTerminationDateTo	Date	not required	Contract termination date to.
6.	submittedDateFrom	DateTime	not required	Submitted date from.
7.	submittedDateTo	DateTime	not required	Submitted date to.
8.	latestStatuses	["String(10)"]	not required	Notification status. Possible meanings: <ul style="list-style-type: none"> • P - Submitted • A – Cancelled • I – Sent • V - In progress • IV – Completed

No.	Attribute	type	obligation	description
				<ul style="list-style-type: none"> K - Error. <p>More than one type can be submitted.</p>
9.	contractTerminationReason	String(1)	not required	<p>Contract termination reason. Possible meanings:</p> <ul style="list-style-type: none"> N - The termination of the contract between customer and the supplier; P - The termination of the contract between customer and the supplier in cases of sale or termination / end of the lease; L – Closure of the object in case of liquidation. M – Termination due to death
10.	userNameSearch	String(240)	not required	The user who created a notification.
11.	declared	Boolean	not required	<p>Indication that there is meter scales declarations. Possible meanings:</p> <ul style="list-style-type: none"> TRUE FALSE

7.6.1.2 JSON Response structure

The table below describes the structure of the JSON response:

No.	Attribute	type	obligation	description
contractTerminationNotification				
1.	notificationId	Integer	required	Notification ID
2.	contractTerminationDate	Date	required	Date of the contract termination

No.	Attribute	type	obligation	description
3.	contractTerminationReason	String(1)	required	<p>Contract termination reason. Possible meanings:</p> <ul style="list-style-type: none"> • N - The termination of the contract between customer and the supplier; • P - The termination of the contract between customer and the supplier in cases of sale or termination / end of the lease; • L – Closure of the object in case of liquidation. • M – Termination due to death
4.	userName	String(240)	not required	The user who created the post.
5.	submittedDate	DateTime	required	Submitted date of notification.
6.	latestStatus	String(10)	required	<p>Notification latest status. Possible meanings:</p> <ul style="list-style-type: none"> • P - Submitted • A – Cancelled • I - Sent • V - In progress • IV – Completed • K - Error.

No.	Attribute	type	obligation	description
7.	errorType	String(10)	not required	<p>Notification error type if status=K (Error). Possible meanings:</p> <ul style="list-style-type: none"> ▪ KT - Other works performed, the contract is not terminated, the object is not liquidated ▪ NL - Failed to access object, object not liquidated ▪ NP - The contract has already been terminated ▪ KL - Incorrect message ▪ NN - Termination is not possible because the data of the old contract does not match ▪ NS - Termination is not possible, the contract will be terminated with a change of the owner / owner and supplier notification ▪ ND – It is not possible to carry out liquidation work ▪ NA - Termination not possible, owner has not been changed <p>Notification error type if status='IV' (Completed). Possible meanings:</p> <ul style="list-style-type: none"> • RN - The contract has been terminated but the meter scale(s) declarations have not been accepted by ESO, please submit the meter scale(s) declarations via the NT Portal.
objects: []				
8.	personName	String(200)	required	Contract owner / tenant name.
9.	personSurname	String(50)	not required	Contract owner / tenant name surname.
10.	personCode	String(20)	not required	Contract owner / tenant person / company code.
11.	consumerCode	String(20)	required	Contract owner / tenant consumer code.
12.	objectNumber	String(20)	required	Object number.
13.	objectAddress	String(4000)	required	Object address.
14.	contractType	String(10)	required	<p>Contract type. Possible meanings:</p> <ul style="list-style-type: none"> • SBTS - Household contract; • SKMS - Commercial contract.

No.	Attribute	type	obligation	description
15.	contractModel	String(10)	required	Contract model of the current object. Possible meanings: <ul style="list-style-type: none"> • BSS - General contract bills; • 2S2S - Two contracts – Two bills.
16.	contractStart	Date	required	Date of entry into force of the notification subject to the independent supplier from.
17.	coowner	Boolean	not required	Indication that there is co-owner.
18.	coownerConsentDate	Date	not required	Date of co-owner's consent.
19.	meterNumbers	["String"]	not required	Object meter (meters).
20.	meterDeclarations: []			
20.1	meterNumber	String	not required	Object meter's number.
20.2	meterReadings: []			
20.2.1	scaleIdentifier	String	not required	Internal scale identifier. Possible meanings: <ul style="list-style-type: none"> • VT; • DD; • DN; • +QsumTS; • +WsumT1; • +WsumT2; • +WsumT3; • +WsumT4; • -QsumTS; • -WsumTS.
20.2.2	scaleProduct	String	not required	Internal scale product. Possible values: <ul style="list-style-type: none"> • D1 – day electricity; • D2 – evening electricity; • DD – electricity at day tariff; • MA- maximum loads;

No.	Attribute	type	obligation	description
				<ul style="list-style-type: none"> • MI – minimum loads; • N1 – night electricity; • N2 – morning electricity; • NK – electricity at night, Saturday, Sunday tariff; • RG- reactive electricity generated; • RV – reactive electricity consumption; • SV – Saturdays, Sundays, and holidays electricity; • VD – average loads; • VK - one time zone.
20.2.3	readingValue	Integer	not required	Meter's scale reading value.
20.2.4	readingValueDate	Date	not required	<ul style="list-style-type: none"> • Meter's scale reading value date. • Format: YYYY-MM-DD.
contractTerminationNotificationStatus				
19.	status	String(10)	required	<p>Notification status. Possible meanings:</p> <ul style="list-style-type: none"> • P - Submitted • A – Cancelled • I - Sent • V - In progress • IV - Completed • K - Error.
20.	statusDate	DateTime	required	Status date.

7.6.1.3 Error Response structure

The following table describes the JSON structure in the event of a response error:

No.	Attribute	type	obligation	description
1.	code	number	required	Error code.
2.	text	string(4000)	required	Error message.

7.6.2 POST /gateway/notification/contract/termination

URL	POST /gateway/notification/contract/termination
Description	The method is for NT to transfer contract termination to DH.
Parameters	<p>URL parameters:</p> <p>The data of the JSON form request are presented in the HTTP request body (BODY) (Query JSON structure, below).</p>
Header	After decrypting the supplier authentication key, the supplier ID is used to select the data.
JSON request	<pre>{ "contractTerminationDate": "date", "contractTerminationReason": "string", "consentSign": "boolean", "objects": [{ "objectNumber": "string", "coowner": "boolean", "coownerConsentDate": "date", "meterDeclarations": [{ "meterNumber": "string", "meterReadings": [{ "scaleIdentifier": "string", "scaleProduct": "string", "readingValue": "integer", "readingValueDate": "date" }] }] }] }</pre>

	<pre>] }] }] } </pre>				
Response HTTP code	HTTP status code	Reason	Description		
	201	Created	Request completed successfully		
	400	Bad Request	Request error. The HTTP response body provides a list of errors in JSON format. (<i>Error response of the JSON structure below</i>).		
	401	Unauthorized	An attempt was made to connect to a non-public method that requires authentication, but no user credentials were provided.		
	403	Forbidden	According to the access control policy, the current user does not have access to perform the requested action.		
	404	Not Found	Either there is no API method associated with the request URL path, or the request contains one or more parameters that did not return the data.		
JSON response	<pre> { "notificationId": "integer" } </pre>				
JSON error response	<pre> { "errorMessages": [{ "code": "integer", "text": "string" }] } </pre>				
Rules	No.	Rule description	Error code	Error message	Attributes

	0.	If an attribute has defined possible values, the value index can be specified by specifying the value of the attribute in the request. Indices of all possible values start from 0.	-	-	All attributes with specified values.
	1.	Submitted object cannot have the same / matching meters numbers.	76	Contract termination not possible. Objects: [objectNumber (if there is more than one object, objects must be separated by the semicolon)] have the same / matching meter number.	object_meter.meter_number , object_meter.valid_from, object_meter.valid_to, object.object_number, object.object_id, objectNumber
	2.	The attribute [ObjectNumber] is mandatory.	-	-	objectNumber
	3.	The meaning of the [ObjectNumber] notification cannot be repeated.	7	The object: [objectNumber (if there is more than one object, objects must be separated by the semicolon)] is repeating..	objectNumber
	4.	Must be specified valid object.	8	The object: [objectNumber (if there is more than one object, objects must be separated by the semicolon)] is not valid.	objectNumber
	5.	The object must belong to a valid supplier contract that provides the notification.	9	The object: [objectNumber (if there is more than one object, objects must be separated by the semicolon)] does not belong to a valid supplier contract.	objectNumber, independentSupplierId, independent_supplier_objects.valid_from, independent_supplier_objects.valid_to, contract.conclusion_date
	6.	The attribute [contractTerminationDate] format must be: yyyy-mm-dd. yyyy - year; mm - month; dd - day.	-	-	contractTerminationDate
	7.	The attribute [contractTerminationReason] must be:	-	-	contractTerminationReason

	<ul style="list-style-type: none"> ▪ N or ▪ P or ▪ L or ▪ M 			
8.	Attributes [contractTerminationDate] and [contractTerminationReason] are mandatory.	-	-	contractTerminationDate, contractTerminationReason
9.	If the attribute [contractTerminationreason]=P , then the attribute [contractTerminationDate] can be equal to the current date or later. Ex.: If the current date is 2021-02-08 , then [contractTerminationDate] start date can be any date from 2021-02-08 to X day to the future.	71	Date of the contract termination [contractTerminationDate] can be equal to the current date or later.	contractTerminationDate
10.	If the attribute [contractTerminationreason]=L or attribute [contractTerminationreason]=M , then the attribute [contractTerminationDate] must be equal to the current date.	72	Date of the contract termination [contractTerminationDate] must be equal to the current date.	contractTerminationDate
11.	Date of the contract termination cannot be equal to date of contract start.	73	Date of the contract termination [contractTerminationDate] cannot be equal to objects [objectNumber (if there is more than one object, objects must be separated by the semicolon)] contract start date.	objectNumber, contract_object.valid_from, independent_supplier_object.valid_from, contractTerminationDate
12.	The contract cannot be terminated for the object if the termination has already been submitted / in progress/ completed / sent.	74	The contract cannot be terminated for the object [objectNumber (if there is more than one object, objects must be separated by the semicolon)] because the termination of the contract has already been submitted.	objectNumber, contract_termination_notification.object_number, contract_termination_notification_object.contract_object_id,

					contract_termination_notification_status
13.	The meaning of the [consentSign] must be: <ul style="list-style-type: none"> ▪ True or ▪ False. 	-	-		consentSign
14.	If the attribute [consentSign] = False , then the contract termination must be disabled.	32	It is necessary to confirm that the data provided is correct.		consentSign
15.	Upon successful creation of a contract termination request, the status of the request becomes "Submitted".	-	-		contract_termination_notification_status.status, contract_termination_notification_status.status_date
16.	The involved party will be identified by the authentication key.	1003	The involved party cannot be found in the system or involved party is not active.		independent_supplier.id, contract_termination_notification.independent_supplier_id
17.	All objects of the notification must belong to the same contract.	43	Change not possible. Different contracts for submitted objects.		objectNumber, consumerCode
18.	Date of the contract termination cannot be later than the date of contract end.	120	Date of the contract termination [contractTerminationDate] cannot be later than objects [objectNumber (if there is more than one object, objects must be separated by the semicolon)] the date of contract end.		objectNumber, contract_object.valid_to, independent_supplier_object.valid_to, contractTerminationDate
19.	If [contractTerminationReason] =L , then one of the fields is required: <ul style="list-style-type: none"> • coowner or • coownerConsentDate An error occurs when neither is not specified.	121	If contract termination reason is "Closure of the object in case of liquidation", then one of the attributes is required "No co-owner" or "Co-owner consent date".		contractTerminationReason, coowner, coownerConsentDate

	20.	If [contractTerminationReason] is not equal L, then the fields must not be specified: <ul style="list-style-type: none"> • coowner • coownerConsentDate 	122	If contract termination reason is not "Closure of the object in case of liquidation", then attributes "No co-owner", "Co-owner consent date" must not be specified.	contractTerminationReason, coowner, coownerConsentDate
	21.	Values of attribute [coowner] must be: <ul style="list-style-type: none"> ▪ True ▪ False 	-	-	coowner
	22.	The format of attribute [coownerConsentDate] must be yyyy-mm-dd.	-	-	coownerConsentDate
	23.	If the field [ntGetCoownerConsent] is specified, the field [coownerConsentDate] must be specified.	124	If the attribute "NT-get co-owner consent" is specified, then must be specified "Co-owner consent date".	ntGetCoownerConsent, coownerConsentDate
	24.	If the field [ntGetCoownerConsent] is not specified, the field [coownerConsentDate] must be not specified.	125	If the attribute "NT-get co-owner consent" is not specified, then must be not specified "Co-owner consent date".	ntGetCoownerConsent, coownerConsentDate
	25.	If [contractTerminationReason] =L or P or M, then it can be filed only one object for one termination of contract request.	127	If contract termination reason is "Closure of the object in case of liquidation" or "The termination of the contract between customer and the supplier in cases of sale or termination / end of the lease" or "Termination due to death", then it can be filed only one object for one termination of contract request.	contractTerminationReason, objectNumber
	26.	If the field [coowner]=TRUE, the field [coownerConsentDate] must be specified.	128	If there is a co-owner, the date of the co-owner's consent must be indicated. If there is not a co-owner, the date of consent is not indicated.	coowner, coownerConsentDate

	If the field [coowner]=FALSE, the field [coownerConsentDate] must be not specified.			
27.	<p>If the attribute generatingObjectType is G (generating consumer) or generatingObjectType is N (remote generating consumer), then fields must not be specified:</p> <ul style="list-style-type: none"> • meterNumber • scaleIdentifier; • scaleProduct; • readingValue; • readingValueDate 	152	If consumer type is generating user or remote generating consumer, then attributes "Meter number", "Scale identifier ", "Scale product", "Reading value", "Reading value date" must not be specified.	generatingObjectType, meterNumber, scaleIdentifier, scaleProduct, readingValue, readingValueDate
28.	Reading values can only be filled for valid scales.	153	The object [objectNumber] meter(s) and/or meter scale(s) does not exist or is no longer valid. Please check provided data.	meterNumber, scaleIdentifier, scaleProduct
29.	It is mandatory to fill the scales of all meters in the object at the same time.	154	All meters with all scales of the [objectNumber] object must be filled.	meterNumber, scaleIdentifier, scaleProduct, readingValue, readingValueDate
30.	Meter scale and scale product cannot be repeated for the same object.	155	The object [objectNumber] meter [meterNumber] scale and scale product combination cannot be repeated.	meterNumber, scaleIdentifier, scaleProduct
31.	If at least one of the reading statement attributes [meterNumber], [scaleIdentifier], [scaleProduct], [readingValue], [readingValueDate] is specified, then all attributes must be filled in.	156	If at least one attribute of the reading statement is specified, then all attributes must be in indicated: "Meter number", "Scale identifier", "Scale product", "Reading value", "Reading value date".	meterNumber, scaleIdentifier, scaleProduct, readingValue, readingValueDate
32.	Attribute [readingValueDate] can be equal to the current date or earlier then current.	157	The reading date [readingValueDate] can be equal to the current date or earlier than current.	readingValueDate

		Ex.: If current date is 2023-11-27, then [readingValueDate] can be any date inclusive from 2023-11-27 to X date in the past.			
33.	The attribute [readingValueDate] must match for all object's scales.	158	The reading date must match for all object's scales.	readingValueDate	
34.	The maximum number of characters in the reading readingValue is checked.	159	Incorrect number of digits in "Reading value" field. Please check maximum number of digits in scale.	readingValue	
35.	If [contractTerminationReason]=N or [contractTerminationReason]=L, then fields must not be specified: <ul style="list-style-type: none"> • meterNumber • scaleIdentifier; • scaleProduct; • readingValue; • readingValueDate 	161	If contract termination reason is "Termination of the contract between customer and the supplier" or "Closure of the object in case of liquidation", then attributes "Meter number", "Scale identifier", "Scale product", "Reading value", "Reading value date" must not be specified.	contractTerminationReason, meterNumber, scaleIdentifier, scaleProduct, readingValue, readingValueDate	
36.	The attribute [meterNumber] shall not be repeated in the message for the same object.	164	The meter numbers of the object [objectNumber] cannot be repeated.	objectNumber, meterNumber	

7.6.2.1 JSON Request structure

The table below describes the structure of the JSON request:

No.	Attribute	type	obligation	description
1.	contractTerminationDate	Date	required	Date of contract termination.
2.	contractTerminationReason	String(1)	required	Contract termination reason. Possible meanings:

No.	Attribute	type	obligation	description
				<ul style="list-style-type: none"> • N - The termination of the contract between customer and the supplier; • P - The termination of the contract between customer and the supplier in cases of sale or termination / end of the lease; • L – Closure of the object in case of liquidation • M - Termination due to death.
3.	consentSign	Boolean	required	<p>Indication of whether the data provided by the contract owner / owner and supplier are correct. Possible meanings:</p> <ul style="list-style-type: none"> • True; • False.
objects: []				
4.	objectNumber	String	required	Object number.
5.	coowner	Boolean	not required	Indication that there is co-owner.
6.	ntGetCoownerConsent	Boolean	not required	Indication of whether the independent supplier has obtained the consent of the co-owner.
7.	coownerConsentDate	Date	not required	Date of co-owner's consent.
8.	meterDeclarations: []			
8.1	meterNumber	String	not required	Object meter's number.
8.2	meterReadings: []			
8.2.1	scaleIdentifier	String	not required	<p>Internal scale identifier. Possible meanings:</p> <ul style="list-style-type: none"> • VT; • DD; • DN; • +QsumTS; • +WsumT1; • +WsumT2;

No.	Attribute	type	obligation	description
				<ul style="list-style-type: none"> • +WsumT3; • +WsumT4; • -QsumTS; • -WsumTS.
8.2.2	scaleProduct	String	not required	<p>Internal scale product. Possible values:</p> <ul style="list-style-type: none"> • D1 – day electricity; • D2 – evening electricity; • DD – electricity at day tariff; • MA- maximum loads; • MI – minimum loads; • N1 – night electricity; • N2 – morning electricity; • 8NK – electricity at night, Saturday, Sunday tariff; • RG- reactive electricity generated; • RV – reactive electricity consumption; • SV – Saturdays, Sundays, and holidays electricity; • VD – average loads; • VK - one time zone.
8.2.3	readingValue	Integer	not required	Meter's scale reading value.
8.2.4	readingValueDate	Date	not required	<ul style="list-style-type: none"> • Meter's scale reading value date. • Format: YYYY-MM-DD.

7.6.2.2 JSON Response structure

The following table describes the JSON structure in the event of a response:

No.	Attribute	type	obligation	description
1.	notificationId	Integer	required	Notification ID.

7.6.2.3 Error Response structure

The following table describes the JSON structure in the event of a response error:

No.	Attribute	type	obligation	description
1.	code	number	required	Error code.
2.	text	string(4000)	required	Error message.

7.6.3 POST /gateway/notification/{notificationId}/contract/termination/cancel

URL	POST /gateway/notification/{notificationId}/contract/termination/cancel		
Description	The method is to cancel the contract termination notification.		
Parameters	URL parameters: <ul style="list-style-type: none"> notificationId – message identifier. Mandatory. 		
Header	After encrypting the supplier authentication key, the supplier ID is used to verify that the supplier is revoking its message.		
Request	POST request does not have the BODY part.		
Response HTTP code	HTTP status code	Reason	Description
	201	Created	Request completed successfully.
	400	Bad Request	Request error. The HTTP response body provides a list of errors in JSON format. (<i>Error response of the JSON structure below</i>).
	401	Unauthorized	An attempt was made to connect to a non-public method that requires authentication, but no user credentials were provided.
	403	Forbidden	According to the access control policy, the current user does not have access to perform the requested action.

	404	Not Found	Either there is no API method associated with the request URL path, or the request contains one or more parameters that did not return the data.		
Response					
JSON error response	<pre>{ "errorMessages": [{ "code": 0, "text": "string" }] }</pre>				
Rules	No.	Rule description	Error code	Error message	Attributes
	0.	If an attribute has defined possible values, the value index can be specified by specifying the value of the attribute in the request. Indices of all possible values start from 0.	-	-	All attributes with specified values.
	1.	<p>The request can be canceled:</p> <ul style="list-style-type: none"> • only one time; • when the notification state is "Pateiktas"; • when the cancellation deadline has not passed (Initial value - 1 hour). 	50	According to the given parameters, the message to be canceled could not be found / the cancellation deadline has expired / the message has already been canceled.	contract_termination_notification_status.status, contract_termination_notification_status.status.date

	2.	Upon successful cancellation of the contract termination request, the status of the request becomes "Atšauktas".	-	-	contract_termination_notification_status.status, contract_termination_notification_status.date
--	----	--	---	---	--

7.6.3.1 Error Response structure

The following table describes the JSON structure in the event of a response error:

No.	Attribute	type	obligation	description
1.	code	number	required	Error code.
2.	text	string(4000)	required	Error message.

7.7 Notification contract object supply state controller

7.7.1 POST /gateway/notification/v2/contract/object/supply-state/list

URI	POST /gateway/notification/contract/v2/object/supply-state/list?first={integer}&count={integer}&sortOrder={ASC/DSC}
Description	The method is to obtain a list of object's disconnection/connection.
Parameters	<p>URL parameters:</p> <ul style="list-style-type: none"> • first - the index of the notification, which must be the first in the return list (starting from 0). Optional. The default value is 0. • count - the number of notification rows in the return list. Optional. The default value is 30. • sort - possible values ASC, DSC. <ul style="list-style-type: none"> • By default, the list should be sorted by the "notificationId" - the latest request records should be displayed at the top of the list; • Must be able to sort list entries by all list fields except status history; <p>The data of the JSON form request are presented in the HTTP request body (BODY) (Query JSON structure, below).</p>
Header	After decrypting the supplier authentication key, the supplier ID is used to select the data.

JSON request	<pre> { "notificationId":"number", "personCode":"string", "consumerCode":"string", "objectNumber":"string", "objectAddressSearch":"string", "changeType":["string"], "latestStatuses":["string"], "submittedDateFrom":"datetime", "submittedDateTo":"datetime", "contractType":"string", "contractModel":"string", "userNameSearch":"string" } </pre>		
Response HTTP code	HTTP status code	Reason	Description
	200	OK	Request completed successfully
	204	No Content	No data found according to the given parameters.
	400	Bad Request	Request error. The HTTP response body provides a list of errors in JSON format. (<i>Error response of the JSON structure below</i>).
	401	Unauthorized	An attempt was made to connect to a non-public method that requires authentication, but no user credentials were provided.
	403	Forbidden	According to the access control policy, the current user does not have access to perform the requested action.
	404	Not Found	Either there is no API method associated with the request URL path, or the request contains one or more parameters that did not return the data.
JSON response	<pre> [{ "notificationId":"number", </pre>		

```

"changeType":"string",
"notes":"string",
"submittedDate":"datetime",
"latestStatus":"string",
"errorType":"string",
"userName":"string",
"currentObjectData":{
  "objectNumber":"string",
  "objectAddress":"string",
  "personName":"string",
  "personSurname":"string",
  "personCode":"string",
  "consumerCode":"string",
  "contractType":"string",
  "contractModel":"string",
  "objectSupplyState":"string",
  "objectSupplyStateValidFrom":"date",
  "objectSupplyStateValidTo":"date",
  "sociallyVulnerable":"boolean"
},
"supplyStateNotificationStatus":[
  {
    "status":"string",
    "statusDate":"datetime"
  }
]
}
]

```

JSON error response

```

{
  "errorMessages": [
    {
      "code": 0,
      "text": "string"
    }
  ]
}

```

<pre> }] } </pre>					
Rules	No.	Rule description	Error code	Error message	Attributes
	0.	If an attribute has defined possible values, the value index can be specified by specifying the value of the attribute in the request. Indices of all possible values start from 0.	-	-	All attributes with specified values.
	1.	No data found according to the given parameters.	HTTP 204	-	-
	2.	The date from cannot be later than the date to. Equal can be.	1002	Date from cannot be later than date to.	submittedDateFrom, contractTerminationDateFrom
	3.	The value of the count parameter must be less or equal to 10000.	1007	The value of the count parameter must be less or equal to 10000.	Count
	4.	Submitted date cannot be later than the current date, but can be equal.	1010	Submitted date cannot be later than the current date.	submittedDateFrom, submittedDateTo

7.7.1.1 JSON Request structure

The table below describes the structure of the JSON request:

No.	Attribute	type	obligation	Description
1.	notificationId	Integer	not required	Disconnection/connection notification ID.
2.	personCode	String(20)	not required	Contract owner / tenant person / company code.
3.	consumerCode	String(20)	not required	Contract owner / tenant consumer code.
4.	objectNumber	String(20)	not required	Object number.
5.	objectAddressSearch	String(4000)	not required	Object address. The search by the fragment.
6.	changeType	["string"]	not required	<p>Disconnection/connection change type. Possible meanings:</p> <ul style="list-style-type: none"> • D – Disconnection at the request of the consumer; • DD – Disconnection due to the debt; • C – Connection of the consumer; • CD – Connection of the consumer after payment of the debt. <p>More than one exchange type can be selected.</p>
7.	latestStatuses	["string(20)"]	not required	<p>Notification newest status. Possible meanings:</p> <ul style="list-style-type: none"> • P - Submitted • A - Cancelled • I - Sent • V – In progress • IV - Completed • K - Error <p>More than one exchange type can be selected.</p>
8.	submittedDateFrom	DateTime	not required	<ul style="list-style-type: none"> • The submission date from of the notification. • Format: yyyy-mm-dd
9.	submittedDateTo	DateTime	not required	<ul style="list-style-type: none"> • The summation date to of the notification. • Format: yyyy-mm-dd
10.	contractType	String(20)	not required	<p>Contract type of the current object. Possible meanings:</p> <ul style="list-style-type: none"> • SBTS - Household customer;

No.	Attribute	type	obligation	Description
				<ul style="list-style-type: none"> SKMS - Commercial customer.
11.	contractModel	String(10)	not required	Contract model of the current object. Possible meanings: <ul style="list-style-type: none"> BSS - General contract bills; 2S2S - Two contracts – Two bills.
12.	userNameSearch	String(240)	not required	The user who created a notification. Search by the fragment.

7.7.1.2 JSON Response structure

The table below describes the structure of the JSON response:

No.	Attribute	type	obligation	description
1.	notificationId	Integer	required	Disconnection/connection notification ID.
1.	changeType	String(3)	required	Disconnection/connection change type. Possible meanings: <ul style="list-style-type: none"> D – Disconnection at the request of the consumer; DD – Disconnection due to the debt; C – Connection of the consumer; CD – Connection of the consumer after payment of the debt.
2.	notes	String(4000)	not required	Notification notes.
3.	submittedDate	DateTime	required	The submission date of the notification.
5.	latestStatus	String(20)	required	Notification newest status. Possible meanings: <ul style="list-style-type: none"> P - Submitted A - Cancelled I - Sent V – In progress IV - Completed K - Error
6.	errorType	String(10)	not required	Notification error type if status=K (Error).

No.	Attribute	type	obligation	description
				Possible meanings: <ul style="list-style-type: none"> ▪ KL - Incorrect message ▪ OT – The object has no accounting point ▪ BA – Supply state cannot be changed because the data of the old contract does not match ▪ KD - Other works completed ▪ AD - Unable to perform user on/off operations ▪ NB - The facility could not be accessed
7.	userName	String(240)	not required	The user who created a notification
currentObjectData: {}				
8.	objectNumber	String(20)	required	Object number.
9.	objectAddress	String(4000)	required	Object address.
10.	personName	String(200)	required	Contract owner / tenant / company name.
11.	personSurname	String(50)	not required	Contract owner / tenant surname.
12.	personCode	String(20)	not required	Person / tenant / company code. If the subject is an individual than person code must be returned encrypted: [*****][the last 3 symbols of the person code]
13.	consumerCode	String(20)	required	Contract owner / tenant consumer code.
14.	contractType	String(10)	required	Contract type of the current object. Possible meanings: <ul style="list-style-type: none"> • SBTS - Household customer; • SKMS - Commercial customer.
15.	contractModel	String(10)	required	Contract model of the current object. Possible meanings: <ul style="list-style-type: none"> • BSS - General contract bills; • 2S2S - Two contracts – Two bills.
16.	objectSupplyState	String(3)	not required	Contract object's electricity supply state. Possible meanings:

No.	Attribute	type	obligation	description
				T - Supply; P – Disconnected on request ; A - Disconnected under sanction; R – Limited by sanction.
17.	objectSupplyStateValidFrom	Date	not required	The object's electricity supply status is valid from.
18.	objectSupplyStateValidTo	Date	not required	The object's electricity supply status is valid to.
19.	sociallyVulnerable	Boolean	required	An indication of whether the owner/tenant of the object is socially vulnerable.
supplyStateNotificationStatus:[]				
20.	status	String(10)	required	Notification all status. Possible meanings: <ul style="list-style-type: none"> • P - Submitted • A - Cancelled • I - Sent • V – In progress • IV - Completed • K - Error
21.	statusDate	DateTime	required	Date of the status.

7.7.1.3 Error Response structure

The following table describes the JSON structure in the event of a response error:

No.	Attribute	type	obligation	description
1.	code	number	required	Error code.
2.	text	string(4000)	required	Error message.

7.7.2 POST /gateway/notification/contract/object/supply-state

URI	POST /gateway/notification/contract/object/supply-state		
Description	The method is for independent supplier to transfer object's disconnection/connection (supply state change) to DH.		
Parameters	URL: The data of the JSON form request are presented in the HTTP request body (BODY) (Query JSON structure, below).		
Header	After decrypting the supplier authentication key, the supplier ID is used to select the data.		
JSON request	<pre>{ "changeType": "string", "notes": "string", "consentSign": "boolean", "objectNumber": "string" }</pre>		
Response HTTP code	HTTP status code	Reason	Description
	201	Created	Request completed successfully
	400	Bad Request	Request error. The HTTP response body provides a list of errors in JSON format. (<i>Error response of the JSON structure below</i>).
	401	Unauthorized	An attempt was made to connect to a non-public method that requires authentication, but no user credentials were provided.
	403	Forbidden	According to the access control policy, the current user does not have access to perform the requested action.
	404	Not Found	Either there is no API method associated with the request URL path, or the request contains one or more parameters that did not return the data.
JSON response	<pre>{ "notificationId": "number" }</pre>		

JSON error response	<pre> { "errorMessages": [{ "code": 0, "text": "string" }] } </pre>				
Rules	No.	Rule description	Error code	Error message	Attributes
* Date type fields can be filled with time where it should not be according to the rules below. The time will be clipped automatically and the date will be stored without time.					
0.	If an attribute has defined possible values, the value index can be specified by specifying the value of the attribute in the request. Indices of all possible values start from 0.	-	-		All attributes with specified values.
1.	The involved party will be identified by the authentication key.	1003	The involved party cannot be found in the system or involved party is not active.	independent_supplier.id, contract_termination_notification, independent_supplier_id	
2.	The attribute [ObjectNumber] is mandatory.	-	-		objectNumber
3.	Must be specified valid object.	1	Change not possible. The object: [objectNumber] does not found in the system.		objectNumber
4.	The object must belong to a valid supplier contract that provides the notification.	2	Change not possible. The object: [objectNumber] does not belong to a valid supplier contract.		objectNumber, independentSupplierId, independent_supplier_objects.valid_from, independent_supplier_objects.valid_to, contract.conclusion_date

5.	If the object does not have a valid electricity supply status for the current date, the change is not possible.	3	Change not possible. The object [objectNumber] does not have a valid electricity energy supply status.	objectNumber, object_state.state_type
6.	The attribute [changeType] must be: <ul style="list-style-type: none"> • D or • DD or • C or • CD. 	-	-	-
7.	The attribute [changeType] is mandatory.	-	-	changeType
8.	The attribute [changeType] must be = D / DD if the current electricity energy supply state of the object = T - Supply.	4	Change not possible. Object: [objectNumber] current electricity energy supply state is "Supply". Possible change type: "Disconnection at the request of the consumer" or "Disconnection due to the debt".	objectNumber, changeType
9.	The attribute [changeType] must be = C if the current electricity energy supply state of the object = P - Disconnected on request.	5	Change not possible. Object: [objectNumber] current electricity energy supply state is "Disconnected on request". Possible change type: "Connection of the consumer".	objectNumber, changeType
10.	The attribute [changeType] must be = CD if the current electricity energy supply state of the object = A - Disconnected under sanction / R - Limited by sanction.	6	Change not possible. Object: [objectNumber] current electricity energy supply state is "Disconnected under sanction" or "Limited by sanction". Possible change type: "Connection of the	objectNumber, changeType

			consumer after payment of the debt".	
11.	When submitting a new notification, it must be checked whether the system already has a notification with the status =In Progress / Sent / Submitted and whose objectNumber, changeType matches the objectNumber, changeType of the newly submitted notification. If such a notification is found, the change is not possible.	7	Change not possible. The notification has already been submitted to [objectNumber].	objectNumber, changeType
12.	The meaning of the [consentSign] must be: <ul style="list-style-type: none"> • True or • False. 	-	-	consentSign
13.	If the attribute [consentSign] = False, then the contract termination must be disabled.	32	It is necessary to confirm that the data provided is correct.	consentSign
14.	Upon successful creation of a supply state notification, the status of the notification becomes "Submitted".	-	-	supply_state_notification, supply_state_notification_status

7.7.2.1 JSON Request structure

The table below describes the structure of the JSON request:

No.	Attribute	type	obligation	Description
1.	changeType	String(3)	required	Disconnection/connection change type. Possible meanings: <ul style="list-style-type: none"> • D – Disconnection at the request of the consumer; • DD – Disconnection due to the debt; • C – Connection of the consumer; • CD – Connection of the consumer after payment of the debt. More than one exchange type can be selected.
2.	notes	String(4000)	not required	Notification notes.
3.	consentSign	Boolean	required	The consent sign of the notification. Possible meanings: <ul style="list-style-type: none"> • True or • False.
4.	objectNumber	String(20)	required	Object number.

7.7.2.2 JSON Response structure

The table below describes the structure of the JSON response:

No.	Attribute	type	obligation	description
1.	notificationId	Integer	required	Disconnection/connection notification ID.

7.7.2.3 Error Response structure

The following table describes the JSON structure in the event of a response error:

No.	Attribute	type	obligation	description
1.	code	number	required	Error code.
2.	text	string(4000)	required	Error message.

7.7.3 POST /gateway/notification/{notificationId}/contract/object/supply-state/cancel

URI	POST /gateway/notification/{notificationId}/contract/object/supply-state/cancel		
Description	The method is to cancel the disconnection/connection notification.		
Parameters	URL: <i>notificationId</i> – message identifier. Mandatory.		
Header	After decrypting the supplier authentication key, the supplier ID is used to select the data.		
JSON request	POST request does not have the BODY part.		
Response HTTP code	HTTP status code	Reason	Description
	201	OK	Request completed successfully.
	400	Bad Request	Request error. The HTTP response body provides a list of errors in JSON format. (<i>Error response of the JSON structure below</i>).
	401	Unauthorized	An attempt was made to connect to a non-public method that requires authentication, but no user credentials were provided.
	403	Forbidden	According to the access control policy, the current user does not have access to perform the requested action.
	404	Not Found	Either there is no API method associated with the request URL path, or the request contains one or more parameters that did not return the data.
JSON response			
JSON error response	<pre>{ "errorMessages": [{ "code": 0, "text": "string" }] }</pre>		

	<pre>] }</pre>				
Rules	No.	Rule description	Error code	Error message	Attributes
	0.	If an attribute has defined possible values, the value index can be specified by specifying the value of the attribute in the request. Indices of all possible values start from 0.	-	-	All attributes with specified values.
	1.	<p>The request can be canceled:</p> <ul style="list-style-type: none"> • only one time; • when the notification state is "Pateiktas"; • when the cancellation deadline has not passed (Initial value - 1 hour). 	50	According to the given parameters, the message to be canceled could not be found / the cancellation deadline has expired / the message has already been canceled.	supply_state_notification_status.status, supply_state_notification_status.status.date
	2.	Upon successful cancellation, the status of the notification becomes "Atšauktas".	-	-	supply_state_notification_status.status, supply_state_notification_status.status.date

7.7.3.1 Error Response structure

The following table describes the JSON structure in the event of a response error:

No.	Attribute	type	obligation	description
1.	code	number	required	Error code.
2.	text	string(4000)	required	Error message.

7.8 Notification cancellation controller

7.8.1 POST /gateway/notification/v2/cancellation/list

URI	POST /gateway/notification/v2/cancellation/list?first={integer}&count={integer}&sortOrder={ASC/DSC}
Description	The method is designed to obtain notification cancelation request.
Parameters	<p>URL:</p> <ul style="list-style-type: none">• first - index (starting from 0) of the notification that must be presented first in the return list. Optional. The default value is 0.• count - number of notifications in the return list. Optional. The default value is 30.• sort - possible values ASC, DSC. <ul style="list-style-type: none">• By default, the list must be sorted by the column "notificationId". The most recent request records must be displayed at the top of the list;• It shall be possible to sort the list entries by all fields in the list, except status history; <p>The data of the JSON form request are presented in the HTTP request body (BODY) (Query JSON structure, below).</p>
Header	After decrypting the supplier authentication key, the supplier ID is used to select the data.
JSON request	<pre>{ "notificationId": "number", "cancelledNotificationId": "number",</pre>

	<pre> "cancelledNotificationType": ["string"], "objectNumber": "string", "objectAddressSearch": "string", "submittedDateFrom": "datetime", "submittedDateTo": "datetime", "latestStatuses": ["string"], "userNameSearch": "string" } </pre>		
Response HTTP code	HTTP status code	Reason	Description
	200	OK	Request completed successfully
	204	No Content	No data found according to the given parameters.
	400	Bad Request	Request error. The HTTP response body provides a list of errors in JSON format. (<i>Error response of the JSON structure below</i>).
	401	Unauthorized	An attempt was made to connect to a non-public method that requires authentication, but no user credentials were provided.
	403	Forbidden	According to the access control policy, the current user does not have access to perform the requested action.
	404	Not Found	Either there is no API method associated with the request URL path, or the request contains one or more parameters that did not return the data.
JSON response	<pre> [{ "notificationId": "number", "cancelledNotificationId": "number", "cancelledNotificationType": "string", "cancelledFullNotification": "boolean", "userName": "string", "submittedDate": "datetime", </pre>		

	<pre> "latestStatus": "string", "errorType": "string", "objects": [{ "objectNumber": "string", "objectAddress": "string" }], "notificationStatus": [{ "status": "string", "statusDate": "datetime" }]] </pre>				
JSON error response	<pre> { "errorMessages": [{ "code": 0, "text": "string" }] } </pre>				
Rules	No.	Rule description	Error code	Error message	Attributes
	0.	If an attribute has defined possible values, the value index can be specified by specifying the value of the attribute in the request. Indices of all possible values start from 0.	-	-	-
	1.	No data found according to the given parameters.	HTTP 204	-	-
	2.	The date from cannot be later than the date to. Equal can be.	1002	Date from cannot be later than date to.	submittedDateFrom, submittedDateTo

	3.	The value of the count parameter must be less or equal to 10000.	1007	The value of the count parameter must be less or equal to 10000.	Count
	4.	Submitted date cannot be later than the current date but can be equal.	1010	Submitted date cannot be later than the current date.	submittedDateFrom, submittedDateTo

7.8.1.1 JSON Request structure

The table below describes the structure of the JSON request:

No.	Attribute	type	obligation	description
1.	notificationId	Integer	not required	Request identifier. Search is possible by full value
2.	cancelledNotificationId	Integer	not required	Identifier of the cancelation request. Search is possible by full value
3.	cancelledNotificationType	String:[]	not required	<p>Cancelation request type. Possible values:</p> <ul style="list-style-type: none"> • STK - owner and supplier change • NTK - supplier change • SK - owner change • SN - termination of contract • KT - change of contacts • TPK - Change of tariff plans • AP - Disconnect / connect. <p>More than one type can be submitted.</p> <p>For now, it is possible submit only type NTK, AP, SK and STK.</p>
4.	objectNumber	String(20)	not required	Object number. Search is possible by full value
5.	objectAddressSearch	String(4000)	not required	Object address. Search by the fragment.
6.	submittedDateFrom	DateTime	not required	Date of submission "from".
7.	submittedDateTo	DateTime	not required	Date of submission "to".
8.	latestStatuses	["string"]	not required	Message status. The possible values are:

No.	Attribute	type	obligation	description
				<ul style="list-style-type: none"> • P – Submitted • A – Cancelled • I – Sent • V - In progress • IV - Completed • K - Error <p>More than one type can be submitted.</p>
9.	userNameSearch	String(240)	not required	Search by fragment

7.8.1.2 JSON Response structure

The table below describes the structure of the JSON response:

No.	Attribute	type	obligation	description
1.	notificationId	Integer	required	Request identifier.
2.	cancelledNotificationId	Integer	required	Identifier of the cancelation request.
3.	cancelledNotificationType	String(10)	required	<p>Cancelation request type. Possible values are:</p> <ul style="list-style-type: none"> • STK - owner and supplier change • NTK - supplier change • SK - owner change • SN - termination of contract • KT - change of contacts • TPK - Change of tariff plans • AP - Disconnect / connect.
	cancelledFullNotification	Boolean	required	Attribute indicating whether all objects are canceled with cancelation request. If all – then response “YES”, if no – the response “No”.
4.	userName	String(240)	not required	User, that created entry
5.	submittedDate	DateTime	required	Date of notification

No.	Attribute	type	obligation	description
6.	latestStatus	String(10)	required	<p>Latest status of message. The possible values are:</p> <ul style="list-style-type: none"> • P – Submitted • A – Cancelled • I – Sent • V - In progress • IV – Completed • K - Error
7.	errorType	String(10)	not required	<p>Responde in case of error. The value is returned only if the status is "K – Error"</p> <p>Possible meanings are:</p> <ul style="list-style-type: none"> • KL - Incorrect message • AT - Cancellation of a supplier is not possible because the object has already entered into NT; • AN - Supplier cancellation is not possible because the object in the NT does not match the Billing data; • AS - Cancellation of a supplier is not possible because the details of the old contract do not match; • TA – Outstanding due to cancellation submitted; • AB – Cancellation is not possible, work in progress; • SP - The contract has already been rewritten.
objects:[]				
8.	objectNumber	String(20)	not required	Object number
9.	objectAddress	String(4000)	not required	Object address
notificationStatus:[]				
10.	status	String(10)	required	<p>Message status. The possible values are:</p> <ul style="list-style-type: none"> • P – Submitted • A – Cancelled • I – Sent • V - In progress

No.	Attribute	type	obligation	description
				<ul style="list-style-type: none"> IV – Completed K -Error
11.	statusDate	DateTime	required	Status date

7.8.1.3 Error Response structure

The following table describes the JSON structure in the event of a response error:

No.	Attribute	type	obligation	description
1.	code	number	required	Error code.
2.	text	string(4000)	required	Error message.

7.8.2 POST /gateway/notification/cancellation

URI	POST /gateway/notification/cancellation
Description	The method is designed to transfer cancelation request to DH.
Parameters	<p>URL:</p> <p>The data of the JSON form request are presented in the HTTP request body (BODY) (Query JSON structure, below).</p>
Header	After decrypting the supplier authentication key, the supplier ID is used to save the data.
JSON request	<pre>{ "cancelledNotificationId": "number", "cancelledNotificationType": "string", "consentSign": "boolean", "objectNumbers": ["string"] }</pre>

	}				
Response HTTP code	HTTP status code	Reason	Description		
	201	Created	Request completed successfully		
	400	Bad Request	Request error. The HTTP response body provides a list of errors in JSON format. (<i>Error response of the JSON structure below</i>).		
	401	Unauthorized	An attempt was made to connect to a non-public method that requires authentication, but no user credentials were provided.		
	403	Forbidden	According to the access control policy, the current user does not have access to perform the requested action.		
	404	Not Found	Either there is no API method associated with the request URL path, or the request contains one or more parameters that did not return the data.		
JSON response	<pre>{ „notificationId“: „number“ }</pre>				
JSON error response	<pre>{ „errorMessages“: [{ „code“: 0, „text“: „string“ }] }</pre>				
	No.	Rule description	Error code	Error message	Attributes
	0.	If an attribute has defined possible values, the value index can be specified by specifying the value of the attribute in the request. Indices of all possible values start from 0.	-	-	-

	1.	The involved party will be identified by the authentication key.	1003	The involved party cannot be found in the system or involved party is not active.	Independent_supplier.id, cancellation_notification.independent_supplier_id
	2.	Attributes [ObjectNumber], [cancelledNotificationId], [cancelledNotificationType] are mandatory.	-	One or more request parameters are required.	objectNumber
	3.	The values for the [cancelledNotificationType] attribute must be: <ul style="list-style-type: none"> • STK – Owner and supplier change • NTK – Supplier change • SK – Owner change • SN – Contract termination • KT – Contact change • TPK – Tariff plan change • AP – Supply state change So far, the cancellation process has been implemented only for the NTK, AP, SK and STK.	-	-	cancelledNotificationType
	4.	The meaning of the [ObjectNumber] notification cannot be repeated.	7	The object: [objectNumber (if there is more than one object, objects must be separated by the semicolon)] is repeating	objectNumber
	5.	The Supplier can only cancel requests it has made.	601	The request [cancelledNotificationId] does not belong to the supplier, or the canceled request type is incorrect.	objectNumber

	6.	All the objects of the submitted request must belong to the objects of the canceled request.	602	The object: [objectNumber (if there is more than one object, objects must be separated by the semicolon)] does not belong to the cancelled notification [cancelledNotificationId]	objectNumber, cancelledNotificationId
	7.	If the attribute [cancelledNotificationType]=NTK then: <ul style="list-style-type: none"> The latest status of the cancelled request (cancelledNotificationId) must be IV – Completed AND whose contract has not started yet. 	603	If the request type "NTK - change of supplier", the cancellation is only possible for requests with status Completed and whose contract has not started yet.	cancelledNotificationId
	8.	If the attribute [cancelledNotificationType]=NTK , then: <ul style="list-style-type: none"> The cancellation can be made 1 day before the end of the deadline for changing the Supplier. 	604	If the cancellation request type is "NTK - change of supplier", cancellation is possible [1] day(s) before the start of the supplier's contract.	cancelledNotificationType, cancelledNotificationId
	9	With one cancellation request, it can cancel: <ul style="list-style-type: none"> a single request, specifying the request and all its objects to be canceled, or not all objects of a single request, specifying the request to be canceled and its objects to be canceled in that request. 	-	-	-
	10.	Only one non-canceled/non-erroneous cancellation request is possible for the same objectNumber, cancelledNotificationId,	605	The cancellation request for object [objectNumber (if there is more	objectNumber, cancelledNotificationId, cancelledNotificationType, independentSupplierId

	cancelledNotificationType, independentSupplierId.		than one object, objects must be separated by the semicolon)] is already submitted to the system	
11.	The meaning of the [consentSign] must be: <ul style="list-style-type: none"> • True or • False. 		-	consentSign
12.	If the attribute [consentSign] = False , then the cancellation of notification must be disabled.	32	It is necessary to confirm that the data provided is correct.	consentSign
13.	Upon successful creation of a cancellation request, the status of the request becomes "Submitted".	-	-	-
1.	If the status of the canceled request [cancelledNotificationId] is IV, then it is checked whether the date_modified of the canceled request is later than the date of the last data import.	606	Due to possible duplication of information, such a notification to object [objectNumber] is not possible. Please try after 30 minutes.	cancelledNotificationId, object number
14.	It is not possible to cancel if another supplier has already canceled the object contract or independent supplier object valid from date is not equal to contract change notification object's contract start date.	607	A cancellation request for object [objectNumber (if there is more than one object, objects must be separated by the semicolon)] is not possible, another supplier has canceled the contract for the object or the object contract is canceled in the operator's system.	objectNumber, cancelledNotificationId, cancelledNotificationType

	15.	Supply disconnection due to debt cannot be canceled if the facility is equipped with an MDM (new SMART) meter and the request to submitted between (hour from specified in the configuration) until (hour to specified in the configuration) hours	608	Supply disconnection due to debt requests cannot be canceled between [hour from specified in the configuration] until [hour to specified in the configuration] hours.	cancelledNotificationType
	16.	If the attribute [cancelledNotificationType]=AP then: The latest status of the cancelled request (cancelledNotificationId) must be V - In progress.	609	If the cancelled request type is "AP - disconnection due to debt", only in progress requests can be cancelled.	cancelledNotificationId
	17.	If the attribute [cancelledNotificationType]=STK/SK then: <ul style="list-style-type: none"> it is necessary to specify all objects of the cancellation request. 	611	If the request type "STK - change of owner and supplier" or "SK - change of owner" then it is necessary to specify all objects of the cancellation request.	objektNumber, cancelledNotificationId, cancelledNotificationType
	18.	If the attribute [cancelledNotificationType]=SK/STK then: <ul style="list-style-type: none"> The latest status of the cancelled request (cancelledNotificationId) must be V - In progress 	612	If the request type "STK - change of owner and supplier" or "SK - change of owner", the cancellation is only possible for requests with status In progress.	cancelledNotificationId, cancelledNotificationType

7.8.2.1 JSON Request structure

The table below describes the structure of the JSON request:

No.	Attribute	type	obligation	description
1.	cancelledNotificationId	Integer	required	Identifier of the cancelation request.
2.	cancelledNotificationType	String(10)	required	<p>Cancelation request type. Possible values are:</p> <ul style="list-style-type: none"> • STK – owner and supplier change • NTK – supplier change • SK – owner change • SN – termination of contract • KT – change of contacts • TPK – Change of tariff plans • AP – Disconnect / connect <p>For now It is possible submit only type NTK, AP, SK and STK.</p>
3.	consentSign	Boolean	required	An indication of whether the cancellation data provided is correct.
4.	objectNumbers	String	required	The object number for which the request of object cancellation is performed.

7.8.2.2 JSON Response structure

The table below describes the structure of the JSON response:

No.	Attribute	type	obligation	description
1.	notificationId	Integer	required	Request identifier

7.8.2.3 Error Response structure

The following table describes the JSON structure in the event of a response error:

No.	Attribute	type	obligation	description
1.	code	number	required	Error code.
2.	text	string(4000)	required	Error message.

7.8.3 POST /gateway/notification/{notificationId}/cancellation/cancel

URL	POST /gateway/notification/{notificationId}/cancellation/cancel		
Description	The method is designed to cancel cancelation request		
Parameters	URL: <ul style="list-style-type: none"> notificationId – request identifier. Required 		
Header	After decrypting the supplier authentication key, the supplier ID is used to check or supplier cancel his own request		
JSON request	In POST request there isn't BODY		
Response HTTP code	HTTP status code	Reason	Description
	201	Created	Request completed successfully
	400	Bad Request	Request error. The HTTP response body provides a list of errors in JSON format. (<i>Error response of the JSON structure below</i>).
	401	Unauthorized	An attempt was made to connect to a non-public method that requires authentication, but no user credentials were provided.
	403	Forbidden	According to the access control policy, the current user does not have access to perform the requested action.
	404	Not Found	Either there is no API method associated with the request URL path, or the request contains one or more parameters that did not return the data.
JSON response	-		
JSON error response	<pre>{ "errorMessages": [{ "code": 0, "text": "string" }] }</pre>		

	<pre>] } </pre>				
Rules	No.	Rule description	Error code	Error message	Attributes
	0.	If an attribute has defined possible values, the value index can be specified by specifying the value of the attribute in the request. Indices of all possible values start from 0.	-	-	-
	1.	The request can be canceled: <ul style="list-style-type: none"> only one time; when the notification state is "Pateiktas"; when the cancellation deadline has not passed (Initial value - 1 hour). 	50	According to the given parameters, the message to be canceled could not be found / the cancellation deadline has expired / the message has already been canceled.	-
	2.	Upon successful cancellation of the cancellation request, the status of the request becomes "Atšauktas".	-	-	-

7.8.3.1 Error Response structure

The following table describes the JSON structure in the event of a response error:

No.	Attribute	type	obligation	description
1.	code	number	required	Error code.
2.	text	string(4000)	required	Error message.

7.9 Notification contract tariff plan controller

7.9.1 POST /gateway/notification/v2/contract/tariff-plan/list

URL	POST /gateway/notification/v2/contract/tariff-plan/list??first={integer}&count={integer}&sortKey={string}&sortOrder={ASC/DSC}		
Description	The method is designed to obtain an information of tariff change		
Parameters	<p>URL parameters:</p> <ul style="list-style-type: none"> • first - index (starting from 0) of the notification that must be presented first in the return list. Optional. The default value is 0. • count - number of objects in the return list. Optional. The default value is 30. • sort - possible values ASC, DSC. <p>The data of the JSON form request are presented in the HTTP request body (BODY) (Query JSON structure, below).</p>		
Header	After decrypting the supplier authentication key, the supplier ID is used to select the data.		
Request	<pre>{ "notificationId":"number", "personCode":"string", "consumerCode":"string", "objectNumber":"string", "objectAddressSearch":"string", "latestStatuses": ["string"], "submittedDateFrom":"datetime", "submittedDateTo":"datetime", "newTariffPlanSearch":"string", "newTimeZone":"string", "newPayoffMethod":"string", "contractType":"string", "contractModel":"string", "userNameSearch":"string" }</pre>		
Response HTTP codes	HTTP status code	Reason	Description
	200	OK	Request completed successfully.

	204	No Content	No data found according to the given parameters.
	400	Bad Request	Request error. The HTTP response body provides a list of errors in JSON format. (<i>Error response of the JSON structure below</i>).
	401	Unauthorized	An attempt was made to connect to a non-public method that requires authentication, but no user credentials were provided.
	403	Forbidden	According to the access control policy, the current user does not have access to perform the requested action.
	404	Not Found	Either there is no API method associated with the request URL path, or the request contains one or more parameters that did not return the data.

Response

```
[
  {
    "notificationId":"number",
    "latestStatus":"string",
    "errorType":"string",
    "submittedDate":"datetime",
    "userName":"string",
    "objects":[
      {
        "personName":"string",
        "personSurname":"string",
        "personCode":"string",
        "consumerCode":"string",
        "objectNumber":"string",
        "objectAddress":"string",
        "contractType":"string",
        "contractModel":"string",
        "tariffPlan":"string",
        "timeZone":"string",
        "payoffMethod":"string",
        "newTariffPlan":"string",
        "newTimeZone":"string",
        "newPayoffMethod":"string"
      }
    ],
    "status":[
      {
        "status":"string",
```

	<pre> "statusCode": "datetime" }] }] </pre>				
JSON error response	<pre> { "errorMessages": [{ "code": 0, "text": "string" }] } </pre>				
Rules	No.	Rule description	Error code	Error message	Attributes
	0.	If an attribute has defined possible values, the value index can be specified by specifying the value of the attribute in the request. Indices of all possible values start from 0.	-	-	-
	1.	No data found according to the given parameters.	HTTP 204	-	-
	2.	The date from cannot be later than the date to. Equal can be.	1002	Date from cannot be later than date to.	submittedDateFrom, submittedDateTo
	3.	The value of the count parameter must be less or equal to 10000.	1007	The value of the count parameter must be less or equal to 10000.	Count

	4.	Submitted date cannot be later than the current date but can be equal.	1010	Submitted date cannot be later than the current date.	submittedDateFrom, submittedDateTo
--	----	--	------	---	------------------------------------

7.9.1.1 JSON Request structure

The table below describes the structure of the JSON request:

No.	Attribute	type	obligation	Description
1.	notificationId	Integer	not required	Tariff plan change notification ID
2.	personCode	String(20)	not required	Contract owner / tenant person / company code.
3.	consumerCode	String(20)	not required	Contract owner / tenant consumer code.
4.	objectNumber	String(20)	not required	Object number.
5.	objectAddressSearch	String(4000)	not required	Object address. The search by the fragment.
6.	latestStatuses	String(20)	not required	Notification newest status. Possible meanings: <ul style="list-style-type: none"> • P - Submitted • A - Cancelled • I - Sent • V – In progress • IV - Completed • K - Error More then one type can be submitted.
7.	submittedDateFrom	DateTime	not required	<ul style="list-style-type: none"> • The submission date from of the notification. • Format: yyyy-mm-dd
8.	submittedDateTo	DateTime	not required	<ul style="list-style-type: none"> • The summation date to of the notification. • Format: yyyy-mm-dd
9.	contractType	String(20)	not required	Contract type of the current object. Possible meanings:

No.	Attribute	type	obligation	Description
				<ul style="list-style-type: none"> • SBTS - Household customer; • SKMS - Commercial customer.
10.	contractModel	String(10)	not required	Contract model of the current object. Possible meanings: <ul style="list-style-type: none"> • BSS - General contract bills; • 2S2S - Two contracts – Two bills.
11.	newTariffPlanSearch	String(200)	not required	<ul style="list-style-type: none"> • Object's full name of the tariff plan; • Search by the fragment.
12.	newTimeZone	String(4)	not required	Current time zone of the object. Possible meanings: <ul style="list-style-type: none"> • 1 - One; • 2 - Two; • VR - One with reactive; • 4 - Four (Smart); • DR - Differentiated with reactive; • N - Not established.
13.	newPayoffMethod	String(1)	not required	A new payment method for the producing user. Possible values: <ul style="list-style-type: none"> • E - kWh - Recovered electricity energy; • G - kW - The power plant's permissible power; • P - % - Settlement percentage; • S – kWh – PP recovered electricity.
14.	userNameSearch	String(240)	not required	The user who created a notification. Search by the fragment.

7.9.1.2 JSON Response structure

The table below describes the structure of the JSON response:

No.	Attribute	type	obligation	description
1.	notificationId	Integer	required	Tariff plan change notification ID.

No.	Attribute	type	obligation	description
2.	latestStatus	String(20)	required	Notification newest status. Possible meanings: <ul style="list-style-type: none"> • P - Submitted • A - Cancelled • I - Sent • V – In progress • IV - Completed • K - Error
3.	errorType	String(10)	not required	Notification error type if status=K (Error).
4.	submittedDate	DateTime	required	The submission date of the notification
5.	userName	String(240)	not required	The user who initiates the tariff plan change notification
6.	personName	String(200)	required	Contract owner / tenant / company name.
7.	PersonSurname	String(50)	not required	Contract owner / tenant surname.
8.	personCode	String(20)	not required	Person / tenant / company code. If the subject is an individual than person code must be returned encrypted: [*****][the last 3 symbols of the person code]
9.	consumerCode	String(20)	required	Contract owner / tenant consumer code.
10.	objectNumber	String(20)	required	Object number.
11.	objectAddress	String(4000)	required	Object address.
12.	contractType	String(10)	required	Contract type of the current object. Possible meanings: <ul style="list-style-type: none"> • SBTS - Household customer; • SKMS - Commercial customer.
13.	contractModel	String(10)	required	Contract model of the current object. Possible meanings: <ul style="list-style-type: none"> • BSS - General contract bills;

No.	Attribute	type	obligation	description
				<ul style="list-style-type: none"> • 2S2S - Two contracts – Two bills.
14.	tariffPlan	String(200)	required	The object tariff plan. The tariff plan was saved as current during the notification submission.
15.	timeZone	String(4)	required	<p>Time zone of the object which was saved as current. Possible meanings:</p> <ul style="list-style-type: none"> • 1 - One; • 2 - Two; • VR - One with reactive; • 4 - Four (Smart); • DR - Differentiated with reactive; • N - Not established.
16.	payoffMethod	String(1)	required	<p>The method of payment by the producing user. Possible values:</p> <ul style="list-style-type: none"> • E - kWh - Recovered electricity energy; • G - kW - The power plant's permissible power; • P - % - Settlement percentage; • S – kWh – PP recovered electricity.
17.	newTariffPlan	String(200)	required	The new tariff plan of the object
18.	newTimeZone	String(4)	required	<p>The new time zone of the object. Possible meanings:</p> <ul style="list-style-type: none"> • 1 - One; • 2 - Two; • VR - One with reactive; • 4 - Four (Smart); • DR - Differentiated with reactive; • N - Not established.
19.	newPayoffMethod	String(1)	required	A new payment method for the producing user. Possible values:

No.	Attribute	type	obligation	description
				<ul style="list-style-type: none"> • E - kWh - Recovered electricity energy; • G - kW - The power plant's permissible power; • P - % - Settlement percentage; • S – kWh – PP recovered electricity.
20.	status	String(10)	required	Notification all status. Possible meanings: <ul style="list-style-type: none"> • P - Submitted • A - Cancelled • I - Sent • V – In progress • IV - Completed • K - Error
21.	statusDate	DateTime	required	Date of the status.

7.9.1.3 Error Response structure

The following table describes the JSON structure in the event of a response error:

No.	Attribute	type	obligation	description
1.	code	number	required	Error code.
2.	text	string(4000)	required	Error message.

7.9.2 POST /gateway/notification/contract/tariff-plan

URL	POST /gateway/notification/contract/tariff-plan
Description	The method is for independent supplier to transfer the tariff plan change to DH.
Parameters	URL:

	The data of the JSON form request are presented in the HTTP request body (BODY) (Query JSON structure, below).		
Header	After decrypting the supplier authentication key, the supplier ID is used to select the data.		
Request	<pre>{ "consentSign":"boolean", "objects": [{ "objectNumber":"string", "newTariffPlan":"string", "newTimeZone":"string", "newPayoffMethod":"string" }] }</pre>		
Response HTTP codes	HTTP status code	Reason	Description
	201	Created	Request completed successfully
	204	No Content	No data found according to the given parameters.
	400	Bad Request	Request error. The HTTP response body provides a list of errors in JSON format. (<i>Error response of the JSON structure below</i>).
	401	Unauthorized	An attempt was made to connect to a non-public method that requires authentication, but no user credentials were provided.
	403	Forbidden	According to the access control policy, the current user does not have access to perform the requested action.
	404	Not Found	Either there is no API method associated with the request URL path, or the request contains one or more parameters that did not return the data.
Response	<pre>{ "notificationId": "number" }</pre>		

JSON error response	<pre> { "errorMessages": [{ "code": 0, "text": "string" }] } </pre>				
Rules	No.	Rule description	Error code	Error message	Attributes
	0.	If an attribute has defined possible values, the value index can be specified by specifying the value of the attribute in the request. Indices of all possible values start from 0.	-	-	-
	5.	The involved party will be identified by the authentication key.	1003	The involved party cannot be found in the system or involved party is not active.	-
	6.	The meaning of the [ObjectNumber] notification cannot be repeated.	7	The object: [objectNumber (if there is more than one object, objects must be separated by the semicolon)] is repeating.	objectNumber
	7.	Must be specified valid object.	8	The object: [objectNumber (if there is more than one object, objects must be separated by the semicolon)] is not valid.	objectNumber
	8.	The object must belong to a valid supplier contract that provides the notification.	9	The object: [objectNumber (if there is more than one object, objects must be separated by the semicolon)] does not belong to a valid supplier contract.	objectNumber
	9.	All objects of the notification must belong to the same contract.	43	Change not possible. Different contracts for submitted objects.	objectNumber
	10.	<ul style="list-style-type: none"> It is possible to change the tariff plan and/or time zone of the object, if the possible date of changing the tariff plan is earlier than or equal to the current date. 	302	Tariff plan changes are not possible. The object: [objectNumber (if there is more than one object, objects must be separated by the semicolon)] possible tariff plan change date is later than the current date.	objectNumber, tariffPlanChangeDate

	<ul style="list-style-type: none"> The rule should only be applied if the specified tariff plan and/or time zone is not the same as the existing one. 			
11.	If the object contract type = SBTS, then the mandatory attribute is [newTariffPlan].	303	For the object: [objectNumber] it is mandatory to indicate the tariff plan.	newTariffPlan
12.	If the object contract type = SBTS, must be specified valid [newTariffPlan].	304	There is no tariff plan [newTariffPlan].	newTariffPlan
13.	<p>If the object contract type = SBTS, then the meaning of the [newTariffPlan] attribute must be:</p> <ul style="list-style-type: none"> Namai or Namai plius or Standartinis or Išmanusis or Vidutinė įtampa. 	305	The object: [objectNumber] tariff plan must be "Namai" / "Namai plius" / "Standartinis" / "Išmanusis" / "Vidutinė įtampa".	newTariffPlan
14.	If the object contract type = SBTS, then the new tariff plan must not coincide with the current tariff plan.	306	The object: [objectNumber] current tariff plan coincides with new tariff plan.	newTariffPlan
15.	If the object contract type = SBTS and the current tariff plan of object is "Vidutinė įtampa", then the new [newTariffPlan] must be "Vidutinė įtampa".	307	The object: [objectNumber] current tariff plan is "Vidutinė įtampa", then the new tariff plan must be "Vidutinė įtampa".	newTariffPlan
16.	If the object contract type =SBTS, then object tariffPlan=Vidutinė įtampa cannot be specified, if current tariffPlan of object is not "Vidutinė įtampa".	308	The object:[objectNumber] current tariff plan is not "Vidutinė įtampa", then the new tariff plan can be "Namai" / "Namai plius" / "Standartinis" / "Išmanusis".	newTariffPlan
17.	If the contractType=SKMS the attribute [newTariffPlan] must not be specified.	309	Contract type of the object: [objectNumber] is SKMS, the new tariff plan cannot be specified.	newTariffPlan

	The current tariff plan will be assigned to the object.			
18.	The attribute [newTimeZone] is required.	-	-	newTimeZone
19.	If the object contract type = SBTS and attribute [newTariffPlan] = Namai / Namai plius / Standartinis / Vidutinė įtampa, then the attribute [newTimeZone] meaning must be: <ul style="list-style-type: none"> • 1 or • 2. 	310	If the object [objectNumber] the contract type is SBTS and the new tariff plan is "Namai" or "Namai plius" or "Standartinis" or "Vidutinė įtampa", then the new time zone must be One or Two.	newTimeZone, newTariffPlan
20.	If the object contract type = SBTS and attribute [newTariffPlan] = Išmanusis, then the attribute [newTimeZone] meaning must be: <ul style="list-style-type: none"> • 4. 	311	If the object [objectNumber] the contract type is SBTS and the new tariff plan is "Išmanusis", then the new time zone must be "4 (Smart)".	newTimeZone, newTariffPlan
21.	If the object contractType=SKMS and PermittablePowerConsumption <= 30 kw, the attribute's [newTimeZone] possible values: <ul style="list-style-type: none"> • 1 or; • 2. 	312	If the contractType=SKMS of the object: [objectNumber] and PermittablePowerConsumption <= 30 kw, than the new time zone must be "One" or "Two".	newTimeZone
22.	If the object contractType=SKMS and PermittablePowerConsumption > 30 kw, the attribute's [newTimeZone] possible values: <ul style="list-style-type: none"> • VR or; • DR. 	313	If the contractType=SKMS of the object: [objectNumber] and PermittablePowerConsumption > 30 kw, than the new time zone must be "One with reactive" or "Differentiated with reactive ones".	newTimeZone

	23.	The meaning of the [consentSign] must be: <ul style="list-style-type: none"> • True or • False. 	-	-	consentSign
	24.	If the attribute [consentSign] = False, then the tariff plan change must be disabled.	32	It is necessary to confirm that the data provided is correct.	consentSign
	25.	Upon successful creation of a tariff plan change request, the status of the request becomes "Submitted".	-	-	-
	26.	It is possible to change the tariff plan if the supply status of the object is T - Supplied. Otherwise, the change cannot be made.	320	Change not possible. The object's: [objectNumber (if there is more than one object, objects must be separated by the semicolon)] supply status is not "T - Supplied".	objectNumber
	27.	It must be checked whether the permissible power for use is specified for the object.	314	Failed to set usable power for the object [objectNumber] .	objectNumber
	28.	The attribute [payoffMethod] cannot be field if consumer type is not generating consumer [generatingObjectType is not G] or is not remote generating consumer [generatingObjectType is not N] and [contractType is not SBTS].	210	Generating consumer payoff method can be field, if consumer type is GV or NGV and contract type - SBTS.	newPayoffMethod, generatingObjectType
	29.	If the object contract is not signed in the ESO part from supply to distribution , then changing the tariff plan is not possible until the contract is rewritten.	321	The object requires a contract rewrite, so changing the tariff plan/time zone/settlement method will be possible after the contract rewrite process has been completed in ESO.	-
	30.	If the attribute [contractType]=SBTS and the object is a generating user = G (GV) or the object is a remote generating user = N	322	Change not possible. Object: [objectNumber] possible generating capacity user payoff method change [date] date is later than the current date.	payoffMethodChangeDate, objectNumber

		(NGV) and the attribute [payoffmethod] (not null and does not match the current one) is specified, the payoff method can be changed if the date of the change in the generating capacity user payoff method is earlier than or equal to the current date.		
--	--	---	--	--

7.9.2.1 JSON Request structure

The table below describes the structure of the JSON request:

No.	Attribute	type	obligation	description
1.	consentSign	Boolean	required	Indication of whether the data provided for the change of the tariff plan are correct. The default value is False.
2.	objects:[]			
3.	objectNumber	String(20)	required	Object number to whom was initiated tariff plan change.
4.	newTariffPlan	String(200)	not required	The new tariff plan can be specified only for the SBTS. In the case of SKMS, the current tariff plan is set automatically.
5.	newTimeZone	String(4)	required	The new time zone of the object. Possible meanings: <ul style="list-style-type: none"> • 1 - One; • 2 - Two; • VR - One with reactive; • 4 - Four (Smart); • DR - Differentiated with reactive; • N - Not established.
6.	newPayoffMethod	String(1)	not required	A new payment method for the producing user. Possible values: <ul style="list-style-type: none"> • E - kWh - Recovered electricity energy; • G - kW - The power plant's permissible power; • P - % - Settlement percentage;

No.	Attribute	type	obligation	description
				<ul style="list-style-type: none"> S – kWh – PP recovered electricity.

7.9.2.2 JSON Response structure

The table below describes the structure of the JSON response:

No.	Attribute	type	obligation	description
1.	notificationId	Integer	required	Identificatory of the notification.

7.9.2.3 Error Response structure

The following table describes the JSON structure in the event of a response error:

No.	Attribute	type	obligation	description
1.	code	number	required	Error code.
2.	text	string(4000)	required	Error message.

7.9.3 POST /gateway/notification/{notificationId}/contract/tariff-plan/cancel

URL	POST /gateway/notification/{notificationId}/contract/tariff-plan/cancel
Description	The method is intended to cancel the tariff plan change.
Parameters	URL: <ul style="list-style-type: none"> notificationId – Identificatory of the notification. Parameter is mandatory.
Header	After decrypting the supplier authentication key, the supplier ID is used to select the data.
Request	There is no body in the JSON request.

Response HTTP codes	HTTP status code	Reason	Description		
	201	Created	Request completed successfully		
	400	Bad Request	Request error. The HTTP response body provides a list of errors in JSON format. (<i>Error response of the JSON structure below</i>).		
	401	Unauthorized	An attempt was made to connect to a non-public method that requires authentication, but no user credentials were provided.		
	403	Forbidden	According to the access control policy, the current user does not have access to perform the requested action.		
	404	Not Found	Either there is no API method associated with the request URL path, or the request contains one or more parameters that did not return the data.		
Response					
JSON error response	<pre>{ "errorMessages": [{ "code": 0, "text": "string" }] }</pre>				
Rules	No.	Rule description	Error code	Error message	Attributes
	0.	If an attribute has defined possible values, the value index can be specified by specifying the value of the attribute in the request. Indices of all possible values start from 0.	-	-	-

	1.	<p>The request can be canceled:</p> <ul style="list-style-type: none"> • only one time; • when the notification state is "Pateiktas"; • when the cancellation deadline has not passed (Initial value - 1 hour). 	50	<p>According to the given parameters, the message to be canceled could not be found / the cancellation deadline has expired / the message has already been canceled.</p>	-
	2.	<p>Upon successful cancellation of the tariff plan request, the status of the request becomes "Atšauktas".</p>	-	-	-

7.9.3.1 JSON Request structure

The table below describes the structure of the JSON response:

No.	Attribute	type	obligation	description

7.9.3.2 JSON Response structure

The table below describes the structure of the JSON response:

No.	Attribute	type	obligation	description

7.9.3.3 Error Response structure

The following table describes the JSON structure in the event of a response error:

No.	Attribute	type	obligation	description
1.	code	number	required	Error code.
2.	text	string(4000)	required	Error message.

7.10 Notification contract contact controller

7.10.1 POST /gateway/notification/v2/contract/contact/list

URL	POST /gateway/notification/v2/contract/contact/list?first={integer}&count={integer}&sortKey={string}&sortOrder={ASC/DSC}
Description	The method is to obtain a list of contact changes.
Parameters	<p>URL:</p> <ul style="list-style-type: none"> • first - index (starting from 0) of the notification that must be presented first in the return list. Optional. The default value is 0. • count - number of objects in the return list. Optional. The default value is 30. • sort - possible values ASC, DSC. <p>The data of the JSON form request are presented in the HTTP request body (BODY) (Query JSON structure, below).</p>
Header	After decrypting the supplier authentication key, the supplier ID is used to select the data.
JSON request	<pre>{ "notificationId": "number", "personCode": "string", "consumerCode": "string", "objectNumber": "string", "objectAddressSearch": "string", "latestStatuses": ["string"], "submittedDateFrom": "datetime", "submittedDateTo": "datetime",</pre>

	<pre>"contractType": "string", "newCorrespondenceAddressSearch": "string", "newPhoneSearch": "string", "newEmailSearch": "string", "userNameSearch": "string" }</pre>		
Response HTTP codes	HTTP status code	Reason	Description
	200	OK	Request completed successfully.
	204	No Content	No data found according to the given parameters.
	400	Bad Request	Request error. The HTTP response body provides a list of errors in JSON format. (<i>Error response of the JSON structure below</i>).
	401	Unauthorized	An attempt was made to connect to a non-public method that requires authentication, but no user credentials were provided.
	403	Forbidden	According to the access control policy, the current user does not have access to perform the requested action.
	404	Not Found	Either there is no API method associated with the request URL path, or the request contains one or more parameters that did not return the data.
JSON response	<pre>[{ "notificationId": "number", "personName": "string", "personSurname": "string", "personCode": "string", "consumerCode": "string", "contractType": "string", "submittedDate": "datetime", "latestStatus": "string", "errorType": "string", "userName": "string",</pre>		

```

    "newContact": {
      "newCorrespondenceAddress": "string",
      "newMobPhoneNoNetwork": "string",
      "newMobPhoneNo2Network": "string",
      "newPhoneNoNetwork": "string",
      "newMobPhoneNoInvoice": "string",
      "newEmailNetwork": "string",
      "newEmail2Network": "string",
      "newEmailInvoice": "string"
    },
    "contact": {
      "correspondenceAddress": "string",
      "mobPhoneNoNetwork": "string",
      "mobPhoneNo2Network": "string",
      "phoneNoNetwork": "string",
      "mobPhoneNoInvoice": "string",
      "emailNetwork": "string",
      "email2Network": "string",
      "emailInvoice": "string"
    },
    "objects": [
      {
        "objectNumber": "string",
        "objectAddress": "string",
        "newMobPhoneNoObject": "string",
        "mobPhoneNoObject": "string"
      }
    ],
    "status": [
      {
        "status": "string",
        "statusDate": "datetime"
      }
    ]
  }
]

```

JSON error response	<pre> { "errorMessages": [{ "code": 0, "text": "string" }] } </pre>				
Rules	No.	Rule description	Error code	Error message	Attributes
	0.	If an attribute has defined possible values, the value index can be specified by specifying the value of the attribute in the request. Indices of all possible values start from 0.	-	-	-
	1.	No data found according to the given parameters.	HTTP 204	-	-
	2.	The date from cannot be later than the date to. Equal can be.	1002	Date from cannot be later than date To.	submittedDateFrom, submittedDateTo
	3.	The value of the count parameter must be less or equal to 10000.	1007	The value of the count parameter must be less or equal to 10000.	Count
	4.	Submitted date cannot be later than the current date but can be equal.	1010	Submitted date cannot be later than the current date.	submittedDateFrom, submittedDateTo

7.10.1.1 JSON Request structure

The table below describes the structure of the JSON request:

No.	Atributte	Type	Obligation	Description
1.	notificationId	Integer	not required	Contact change notification ID.
2.	personCode	String(20)	not required	Contract owner / tenant person / company code.

No.	Atributte	Type	Obligation	Description
3.	consumerCode	String(20)	not required	Contract owner / tenant consumer code.
4.	objectNumber	String(20)	not required	Object number.
5.	objectAddressSearch	String(4000)	not required	Object address. The search by the fragment.
6.	latestStatuses	["String(20)"]	not required	<p>Notification status. Possible meanings:</p> <ul style="list-style-type: none"> • P - Submitted • A - Cancelled • I - Sent • V – In progress • IV - Completed • K – Error <p>More than one type can be submitted.</p>
7.	submittedDateFrom	DateTime	not required	The submission date from of the notification. Format: yyyy-mm-dd
8.	submittedDateTo	DateTime	not required	The summation date to of the notification. Format: yyyy-mm-dd
9.	contractType	String(20)	not required	<p>Contract type of the current object. Possible meanings:</p> <ul style="list-style-type: none"> • SBTS - Household customer; • SKMS - Commercial customer.
10.	newCorrespondenceAddressSearch	String(4000)	not required	<ul style="list-style-type: none"> • Contract owner's / tenant's full name of correspondence address. • Search by the fragment.
11.	newPhoneSearch	String(4)	not required	<ul style="list-style-type: none"> • Search by the fragment. • Searching for these contacts: <ul style="list-style-type: none"> • Contract owner's / tenant's new mobile phone number for the network. • Contract owner's / tenant's new additional mobile phone number for the network.

No.	Atributte	Type	Obligation	Description
				<ul style="list-style-type: none"> Contract owner's / tenant's new mobile phone number for the invoice. Contract owner's / tenant's new phone number for the network. Object's new mobile phone number for the network.
12.	newEmailSearch	string(100)	not required	<ul style="list-style-type: none"> Search by the fragment. Searching for these contacts: <ul style="list-style-type: none"> Contract owner's / tenant's new email address for the network; Contract owner's / tenant's new additional email address for the network. Contract owner's / tenant's new email address for the invoice;
13.	userNameSearch	String(240)	not required	The user who created a notification. Search by the fragment.

7.10.1.2 JSON Response structure

The table below describes the structure of the JSON response:

No.	Attribute	Type	Obligation	Description
1.	notificationId	integer	required	Contact change notification ID.
2.	personName	string(200)	required	Contract owner / tenant / company name.
3.	personSurname	string(50)	not required	Contract owner / tenant surname.
4.	personCode	string(15)	required	Contract owner / tenant person / company code.
5.	consumerCode	string(20)	required	Contract owner / tenant consumer code.
6.	contractType	string(10)	required	Contract type of the current object. Possible meanings: <ul style="list-style-type: none"> SBTS - Household customer; SKMS - Commercial customer.

No.	Attribute	Type	Obligation	Description
7.	submittedDate	DateTime	required	The submission date of the notification
8.	latestStatus	string(10)	required	Notification newest status. Possible meanings: <ul style="list-style-type: none"> • P - Submitted • A - Cancelled • I - Sent • V – In progress • IV - Completed • K - Error
9.	errorType	String(10)	not required	Notification error type if status=K (Error).
10.	userName	string(240)	required	The user who initiates the contact change notification
newContact{}				
11.	newCorrespondenceAddress	string(4000)	required	Contract owner's / tenant's full name of new correspondence address.
12.	newMobPhoneNoNetwork	string(12)	not required	Contract owner's / tenant's new mobile phone number for the network.
13.	newMobPhoneNo2Network	string(12)	not required	Contract owner's / tenant's new additional mobile phone number for the network.
14.	newPhoneNoNetwork	string(12)	not required	Contract owner's / tenant's new phone number for the network.
15.	newMobPhoneNoInvoice	string(12)	not required	Contract owner's / tenant's new mobile phone number for the invoice.
16.	newEmailNetwork	string(49)	not required	Contract owner's / tenant's new email address for the network.
17.	newEmail2Network	string(49)	not required	Contract owner's / tenant's new additional email address for the network.
18.	newEmailInvoice	string(100)	not required	Contract owner's / tenant's new email address for the invoice.
contact: {}				
19.	correspondenceAddress	string(4000)	not required	Contract owner's / tenant's full name of correspondence address.
20.	mobPhoneNoNetwork	string(12)	not required	Contract owner's / tenant's mobile phone number for the network.

No.	Attribute	Type	Obligation	Description
21.	mobPhoneNo2Network	string(12)	not required	Contract owner's / tenant's additional mobile phone number for the network.
22.	phoneNoNetwork	string(12)	not required	Contract owner's / tenant's phone number for the network.
23.	mobPhoneNoInvoice	string(12)	not required	Contract owner's / tenant's mobile phone number for the invoice.
24.	emailNetwork	string(49)	not required	Contract owner's / tenant's email address for the network.
25.	email2Network	string(49)	not required	Contract owner's / tenant's additional email address for the network.
26.	emailInvoice	string(100)	not required	Contract owner's / tenant's email address for the invoice.
objects:[]				
27.	objectNumber	string(20)	required	Contract object number.
28.	objectAddress	string(4000)	required	Full name of the contract object address.
29.	newMobPhoneNoObject	string(12)	not required	Object's new mobile phone number for the network.
30.	mobPhoneNoObject	string(12)	not required	Object's mobile phone number for the network.
status:[]				
31.	status	String(10)	required	Notification newest status. Possible meanings: <ul style="list-style-type: none"> • P - Submitted • A - Cancelled • I - Sent • V – In progress • IV - Completed • K - Error
32.	statusDate	DateTime	required	Notification status date.

7.10.1.3 Error Response structure

The following table describes the JSON structure in the event of a response error:

No.	Attribute	Type	Obligation	Description
1.	code	number	required	Error code.
2.	text	string(4000)	required	Error message.

7.10.2 POST /gateway/notification/contract/contact

URL	POST /gateway/notification/contract/contact
Description	The method is for independent supplier to transfer the contact change to DH.
Parameters	<p>URL parameters:</p> <p>The data of the JSON form request are presented in the HTTP request body (BODY) (Query JSON structure, below).</p>
Header	After decrypting the supplier authentication key, the supplier ID is used to select the data.
JSON request	<pre>{ "consumerCode": "string", "consentSign": "boolean", "newCorrespondenceAddress": { "newStreet": "string", "newBuilding": "string", "newHousingNo": "string", "newAppartement": "string", "newLocality": "string", "newEldership": "string", "newMunicipality": "string", "newCounty": "string" }, "newContact": { "newMobPhoneNoNetwork": "string", "newMobPhoneNo2Network": "string", </pre>

	<pre> "newMobPhoneNoInvoice": "string", "newPhoneNoNetwork": "string", "newEmailNetwork": "string", "newEmail2Network": "string", "newEmailInvoice": "string" }, "objects": [{ "objectNumber": "string", "newMobPhoneNoObject": "string" }] } </pre>		
Response HTTP codes	HTTP status code	Reason	Description
	201	Created	Request completed successfully.
	400	Bad Request	Request error. The HTTP response body provides a list of errors in JSON format. (<i>Error response of the JSON structure below</i>).
	401	Unauthorized	An attempt was made to connect to a non-public method that requires authentication, but no user credentials were provided.
	403	Forbidden	According to the access control policy, the current user does not have access to perform the requested action.
	404	Not Found	Either there is no API method associated with the request URL path, or the request contains one or more parameters that did not return the data.
JSON response	<pre> { "notificationId": "number" } </pre>		
JSON error response	<pre> { "errorMessages": [{ </pre>		

```

"code": 0,
"text": "string"
}
]
}

```

Rules	No.	Rule description	Error code	Error message	Attributes
	0.	If an attribute has defined possible values, the value index can be specified by specifying the value of the attribute in the request. Indices of all possible values start from 0.	-	-	-
	1.	The involved party will be identified by the authentication key.	1003	The involved party cannot be found in the system or involved party is not active.	-
	2.	The attribute consumerCode is mandatory.	-	-	consumerCode
	3.	The change of contacts can only be performed for the contract that is valid at the moment and the objects of the contract belong to the supplier initiating the change.	410	Change not possible. No valid contract found.	consumerCode
	4.	If the contract type = SBTS, then must be at least one contact attribute: <ul style="list-style-type: none"> • [newMobPhoneNoNetwork] or • [newTelPhoneNoNetwork] or • [newEmailNetwork] 	415	If the contract type is "SBTS", it is mandatory to specify at least one attribute: "Mob. phone no." or "Phone no." or "Email address".	newMobPhoneNoNetwork, newEmailNetwork, newTelPhoneNoNetwork
	5.	If the contract type = SKMS, then must be at least one contact attribute: <ul style="list-style-type: none"> • [newMobPhoneNoNetwork] or • [newEmailNetwork]. 	416	If the contract type is "SKMS", it is mandatory to specify one of the contacts for network work: "Mob. phone no." or "Email Address" and one of the contacts for accounts: "Mob. phone no." or "Email Address".	newMobPhoneNoNetwork, newEmailNetwork, newMobPhoneNoInvoice, newEmailInvoice

	<p>and one of contacts for the invoices;</p> <ul style="list-style-type: none"> • [newMobPhoneNoInvoice] or • [newEmailInvoice]. 			
6.	<p>If the contract type=SBTS then attributes [newMobPhoneNoInvoice] and [newEmailInvoice] cannot be filled.</p>	417	<p>If the contract type "SBTS", then invoice "Mob. phone No." and invoice "Email address" cannot be filled.</p>	<p>newMobPhoneNoInvoice, newEmailInvoice</p>
7.	<p>The format of the attributes [newMobPhoneNoNetwork], [newMobPhoneNo2Network], [newMobPhoneNoInvoice] must be : +3706XXXXXXX, X - an integer (0 must be included).</p> <p>The format of the attribute [newPhoneNoNetwork] must be : +370XXXXXXXX, X - an integer (0 must be included). The next number after +370 cannot be 6.</p>	418	<p>"Mob. phone No.", "Mob. phone No. (optional)" and "Phone no." incorrect format.</p>	<p>newMobPhoneNoNetwork, newMobPhoneNo2Network, newMobPhoneNoInvoice, newPhoneNoNetwork</p>
8.	<p>The format of the attributes [newEmailNetwork], [newEmail2Network], [newEmailInvoice] must be [text][@][text][.domain], letters in the text must be Latin.</p> <p>Can be at most 64 characters up to @ symbol and cannot begin/end with a dot or special character.</p>	419	<p>An "Email address" and "Email address (optional)" incorrect format.</p>	<p>newEmailNetwork, newEmail2Network, newEmailInvoice</p>
9.	<p>The attributes [objectNumber] and [newMobPhoneObject] are only filled in if the contract type is SKMS.</p> <p>The attribute [ObjectNumber] is mandatory if the attribute [newMobPhoneNoObject] is not null.</p>	411	<p>If the contract type is SKMS and "Mobile Phone No." of faults is specified, then "Object No." must be specified.</p>	<p>objectNumber, newMobPhoneNoObject</p>
10.	<p>The meaning of the [ObjectNumber] notification cannot be repeated.</p>	421	<p>The object: [objectNumber] is repeating.</p>	<p>objectNumber</p>

	11.	<p>Must be specified valid object.</p> <p>The object must belong to a valid supplier contract that provides the notification and the object must have at least one valid meter.</p> <p>All objects of the notification must belong to the same contract.</p>	422	The object: [objectNumber] not found in the system / not belong to a valid supplier contract.	objectNumber
	12.	The format of the attribute [newMobPhoneNoObject] must be : +3706XXXXXXX, X - an integer (0 must be included).	414	"Mob. phone No." incorrect format.	newMobPhoneNoObject
	13.	<p>The meaning of the [consentSign] must be:</p> <ul style="list-style-type: none"> • True or • False. 	-	-	consentSign
	14.	If the attribute [consentSign] = False, then the tariff plan change must be disabled.	32	It is necessary to confirm that the data provided is correct.	consentSign
	15.	Upon successful creation of a contact change request, the status of the request becomes "Submitted".	-	-	-
	16.	<p>If the [contractType]=SKMS and there is specified at least one contact for network work, then attributes cannot be filled:</p> <ul style="list-style-type: none"> • newMobPhoneNoNetwork • newEmailNetwork 	423	Contact change not possible. One of the contacts for network work: "Mob. phone no." and / or "Email Address" is submitted.	newMobPhoneNoNetwork, newEmailNetwork
	17.	<p>If the [contractType]=SKMS and there is specified at least one contact for accounts, then attributes cannot be filled:</p> <ul style="list-style-type: none"> • newMobPhoneNoInvoice • newEmailInvoice 	424	Contact change not possible. One of the contacts for accounts: "Mob. phone no." and / or "Email Address" is submitted.	newMobPhoneNoInvoice, newEmailInvoice

7.10.2.1 JSON Request structure

The table below describes the structure of the JSON request:

No.	Attribute	Type	Obligation	Description
1.	consumerCode	Strign(20)	required	Contract owner / tenant consumer code.
2.	consentSign	Boolean	required	Indication that the contact change data provided are correct. The default value is False.
newcorrespondenceAddress: {}				
3.	newStreet	Varchar(200)	not required	New correspondence address's street.
4.	newBuilding	Varchar(100)	not required	New correspondence address's number of the house.
5.	newHousingNo	Varchar(100)	not required	New Correspondence Address's Corps Number.
6.	newAppartment	Varchar(20)	not required	New correspondence address's apartment number.
7.	newLocality	Varchar(200)	not required	New correspondence address's city / village.
8.	newEldership	Varchar(200)	not required	New correspondence address's eldership.
9.	newMunicipality	Varchar(200)	not required	New correspondence address's municipality.
10.	newCounty	Varchar(200)	not required	New Correspondence Address's County.
newContact: {}				
11.	newMobPhoneNoNetwork	Varchar(12)	not required	Contract owner's / tenant's new mobile phone number for the network.
12.	newMobPhoneNo2Network	Varchar(12)	not required	Contract owner's / tenant's new additional mobile phone number for the network.
13.	newMobPhoneNoInvoice	Varchar(12)	not required	Contract owner's / tenant's new mobile phone number for the invoice.
14.	newPhoneNoNetwork	Varchar(12)	not required	Contract owner's / tenant's new phone number for the network.
15.	newEmailNetwork	Varchar(49)	not required	Contract owner's / tenant's new email address for the network.
16.	newEmail2Network	Varchar(49)	not required	Contract owner's / tenant's new additional email address for the network.

No.	Attribute	Type	Obligation	Description
17.	newEmailInvoice	Varchar(100)	not required	Contract owner's / tenant's new email address for the invoice.
object: [] Filled in only in case of SKMS				
18.	objectNumber	Varchar(20)	not required	Contract object number.
19.	newMobPhoneNoObject	Varchar(12)	not required	Object's new mobile phone number for the network.

7.10.2.2 JSON Response structure

The table below describes the structure of the JSON response:

No.	Attribute	Type	Obligation	Description
1.	notificationId	Integer	required	Notification ID.

7.10.2.3 Error Response structure

The following table describes the JSON structure in the event of a response error:

No.	Attribute	Type	Obligation	Description
1.	code	number	required	Error code.
2.	text	string(4000)	required	Error message.

7.10.3 POST /gateway/notification/{notificationId}/contract/contact/cancel

URL	POST /gateway/notification/{notificationId}/contract/contact/cancel
Description	The method is intended to cancel the contact change.
Parameters	<p>URL:</p> <ul style="list-style-type: none"> notificationId – notification identifier. Mandatory

Header	The data of the JSON form request are presented in the HTTP request body (BODY) (Query JSON structure, below).				
JSON request	There is no body in the JSON request.				
Response HTTP codes	HTTP status codes	Reason	Description		
	201	Created	Request completed successfully		
	400	Bad Request	Request error. The HTTP response body provides a list of errors in JSON format. (<i>Error response of the JSON structure below</i>).		
	401	Unauthorized	An attempt was made to connect to a non-public method that requires authentication, but no user credentials were provided.		
	403	Forbidden	According to the access control policy, the current user does not have access to perform the requested action.		
	404	Not Found	Either there is no API method associated with the request URL path, or the request contains one or more parameters that did not return the data.		
JSON response					
JSON error response	<pre> { "errorMessages": [{ "code": 0, "text": "string" }] } </pre>				
Rule	No.	Rule description	Error code	Error message	Attributes
	0.	If an attribute has defined possible values, the value index can be specified by specifying the value of the attribute in the request. Indices of all possible values start from 0.	-	-	-

	1.	<p>The request can be canceled:</p> <ul style="list-style-type: none"> • only one time; • when the notification state is "Pateiktas"; <p>when the cancellation deadline has not passed (Initial value - 1 hour).</p>	50	According to the given parameters, the message to be canceled could not be found / the cancellation deadline has expired / the message has already been canceled.	-
	2.	Upon successful cancellation of the contact request, the status of the request becomes "Atšauktas".	-	-	-

7.10.3.1 JSON Request structure

The table below describes the structure of the JSON request:

No.	Attribute	Type	Obligation	Description
1.				

7.10.3.2 JSON Response structure

The table below describes the structure of the JSON response:

No.	Attribute	Type	Obligation	Description
4.				

7.10.3.3 Error Response structure

The following table describes the JSON structure in the event of a response error:

No.	Attribute	Type	Obligation	Description
1.	code	number	required	Error code.

No.	Attribute	Type	Obligation	Description
2.	text	string(4000)	required	Error message.

7.11 Statistic controller

7.11.1 Statistic names

Service Name	Statistic name	Description
NOTIFICATION	SK_COUNT	Total number of contract owner change notifications.
	SK_OBJECT_COUNT	Total number of objects for contract owner change notifications.
	STK_COUNT	Total number of contract owner and supplier change notifications.
	STK_OBJECT_COUNT	Total number of objects for contract owner and supplier change notifications.
	FROM_VT_TO_NT_STK_OBJECT_COUNT	Total number of objects for contract owner and supplier change notifications from public to independent supplier.
	FROM_GT_TO_NT_STK_OBJECT_COUNT	Total number of objects for contract owner and supplier change notifications from warranty to independent supplier.
	FROM_NT_TO_NT_STK_OBJECT_COUNT	Total number of objects for contract owner and supplier change notifications from independent-to-independent supplier.
	NTK_COUNT	Total number of supplier change notifications.
	NTK_OBJECT_COUNT	Total number of objects for supplier change notifications.
	FROM_VT_TO_NT_NTK_OBJECT_COUNT	Total number of objects for supplier change notifications from public to independent supplier.
	FROM_GT_TO_NT_NTK_OBJECT_COUNT	Total number of objects for supplier change notifications from warranty to independent supplier.
	FROM_NT_TO_NT_NTK_OBJECT_COUNT	Total number of objects for supplier change notifications from independent-to-independent supplier.
	CONTRACT_TERMINATION_COUNT	Total number of contract termination notifications.
	CONTRACT_TERMINATION_OBJECT_COUNT	Total number of objects for contract termination notifications.
NTK_CANCELLATION_COUNT	Total number of cancellations of supplier change notifications.	

	NTK_CANCELLATION_OBJECT_COUNT	Total number of objects for cancellations of supplier change notifications.
	SK_CANCELLATION_COUNT	Total number of cancellations of contract owner change notifications.
	SK_CANCELLATION_OBJECT_COUNT	Total number of objects for cancellations of contract owner change notifications.
	STK_CANCELLATION_COUNT	Total number of cancellations of contract owner change and supplier change notifications.
	STK_CANCELLATION_OBJECT_COUNT	Total number of objects for cancellations of contract owner change and supplier change notifications.
	AP_CANCELLATION_OBJECT_COUNT	Total number of objects for cancellations of supply state change notifications with change type DD (Disconnection due to the debt).
	CONTACT_CHANGE_COUNT	Total number of contact change notifications.
	CONTACT_CHANGE_OBJECT_COUNT	Total number of objects for contact change notifications.
	TARIFF_PLAN_COUNT	Total number of tariff plan change notifications.
	TARIFF_PLAN_OBJECT_COUNT	Total number of objects for tariff plan change notifications.
	SUPPLY_STATE_OBJECT_COUNT	Total number of objects for supply state change notifications.
DECLARATION	DECLARATION_OBJECT_COUNT	Total number of declared objects.
ACCESS_RIGHT	ACCESS_RIGHT_COUNT	Total number of rights granted.
CONTRACT_OBJECT	CONTRACT_OBJECT_COUNT	Total number of supplier objects.
BILL	BILL_COUNT	Total number of bills.
	BILL_OBJECT_COUNT	Total number of objects for bills.
ORDER	REPORT_OBJ_COUNT	Total number of orders (object report).
	REPORT_OBJ_OBJECT_COUNT	Total number of objects for orders (object report).
	REPORT_OBJ_ACR_COUNT	Total number of orders (object report based on granted rights).
	REPORT_OBJ_ACR_OBJECT_COUNT	Total number of objects for orders (object report based on granted rights).
	DATA_HR_15MIN_MTR_LVL_QUARTER_COUNT	Total number of orders (15MIN automated quantities at the meter level report).
	DATA_HR_15MIN_MTR_LVL_QUARTER_OBJECT_COUNT	Total number of objects for orders (15MIN automated quantities at the meter level report).
	DATA_HR_15MIN_OBJ_LVL_QUARTER_COUNT	Total number of orders (15MIN automated quantities at the object level report).

DATA_HR_15MIN_OBJ_LVL_QUARTER_OBJECT_COUNT	Total number of objects for orders (15MIN automated quantities at the object level report).
DATA_HR_15MIN_MTR_LVL_ACR_QUARTER_COUNT	Total number of orders (15MIN automated quantities at the meter level report based on granted rights).
DATA_HR_15MIN_MTR_LVL_ACR_QUARTER_OBJECT_COUNT	Total number of objects for orders (15MIN automated quantities at the meter level report based on granted rights).
DATA_HR_15MIN_OBJ_LVL_ACR_QUARTER_COUNT	Total number of orders (15MIN automated quantities at the object level report based on granted rights).
DATA_HR_15MIN_OBJ_LVL_ACR_QUARTER_OBJECT_COUNT	Total number of objects for orders (15MIN automated quantities at the object level report based on granted rights).
DATA_HR_15MIN_MTR_LVL_HOUR_COUNT	Total number of orders (HOUR automated quantities at the meter level report).
DATA_HR_15MIN_MTR_LVL_HOUR_OBJECT_COUNT	Total number of objects for orders (HOUR automated quantities at the meter level report).
DATA_HR_15MIN_OBJ_LVL_HOUR_COUNT	Total number of orders (HOUR automated quantities at the object level report).
DATA_HR_15MIN_OBJ_LVL_HOUR_OBJECT_COUNT	Total number of objects for orders (HOUR automated quantities at the object level report).
DATA_HR_15MIN_OBJ_LVL_ACR_HOUR_COUNT	Total number of orders (HOUR automated quantities at the object level report based on granted rights).
DATA_HR_15MIN_OBJ_LVL_ACR_HOUR_OBJECT_COUNT	Total number of objects for orders (HOUR automated quantities at the object level report based on granted rights).
DATA_HR_15MIN_MTR_LVL_ACR_HOUR_COUNT	Total number of orders (HOUR automated quantities at the meter level report based on granted rights).
DATA_HR_15MIN_MTR_LVL_ACR_HOUR_OBJECT_COUNT	Total number of objects for orders (HOUR automated quantities at the meter level report based on granted rights).
DATA_SUM_OBJ_LVL_ACR_COUNT	Total number of orders (report of total quantities based on granted rights).
DATA_SUM_OBJ_LVL_ACR_OBJECT_COUNT	Total number of objects for orders (report of total quantities based on granted rights).
BILL_BSS_B2B_COUNT	Total number of orders (billing report for BSS model B2B).
BILL_BSS_B2B_OBJECT_COUNT	Total number of objects for orders (billing report for BSS model B2B).
BILL_BSS_B2C_COUNT	Total number of orders (billing report for BSS model B2C).
BILL_BSS_B2C_OBJECT_COUNT	Total number of objects for orders (billing report for BSS model B2C).
BILL_2S2S_B2B_COUNT	Total number of orders (billing report for 2S2S model B2B).

	BILL_2S2S_B2B_OBJECT_COUNT	Total number of objects for orders (billing report for 2S2S model B2B).
	BALANCE_DATA_QUARTER_COUNT	Total number of balance data reports (15MIN).
	BALANCE_DATA_HOUR_COUNT	Total number of balance data reports (HOUR).
	BALANCE_BY_GENERATION_TYPE_QUARTER_COUNT	Total number of balance by generation type reports (15MIN).
	BALANCE_BY_GENERATION_TYPE_HOUR_COUNT	Total number of balance by generation type reports (HOUR).

7.11.2 GET /gateway/statistic/list

URL	GET gateway/statistic/list		
Description	The method is intended to obtain statistic values.		
Parameter	<p>URL parameters:</p> <ul style="list-style-type: none"> • first - index (starting from 0) of the count that must be presented first in the return list. Optional. The default value is 0. • count - number of entries in the return list. Optional. The default value is 30. • statisticPeriods – statistic periods. Required. • serviceNames – service names. Optional. Possible meanings: <ul style="list-style-type: none"> • NOTIFICATION, DECLARATION, ACCESS_RIGHT, CONTRACT_OBJECT, ORDER, BILL. • statisticNames – statistic names. Optional. The available options are described in 8.1.12.1 Statistic Names. • contractModels – contract models of objects. Optional. Possible meanings: <ul style="list-style-type: none"> • BSS, 2S2S, NONE. • contractTypes – contract types of objects. Optional. Possible meanings: <ul style="list-style-type: none"> • SBTS, SKMS, NONE. • meterAccountingTypes – meter accounting types of objects. Optional. Possible meanings: <ul style="list-style-type: none"> • AUTO, NON-AUTO, NO-METER, NONE. • generatingObjectTypes – generating object types. Optional. Possible meanings: <ul style="list-style-type: none"> • G, N, NO-TYPE, NONE. • filterZeroValue - filter null values. Optional. Possible meanings: <ul style="list-style-type: none"> • true (select records with values more than 0), false (select records with all values). 		
Header	After decrypting the supplier authentication key, the supplier ID is used to select the data.		
JSON request	-		
HTTP Response code	HTTP status code	Reason	Description

	200	Created	Request completed successfully.
	204	No content	No data found according to the given parameters.
	400	Bad Request	Request error. The HTTP response body provides a list of errors in JSON format.
	401	Unauthorized	An attempt was made to connect to a non-public method that requires authentication, but no user credentials were provided.
	403	Forbidden	According to the access control policy, the current user does not have access to perform the requested action.
	404	Not Found	Either there is no API method associated with the request URL path, or the request contains one or more parameters that did not return the data.
JSON response	<pre>{ ["serviceName": "string", "statisticName": "string", "statisticPeriod": "date", "contractModel": "string", "contractType": "string", "generatingObjectType": "string", "meterAccountingType": "string", "statisticValue": "integer"] }</pre>		
JSON error response	<pre>{ "errorMessages": [{ "code": "number", "text": "string" }] }</pre>		

Rules	No.	Rule description	Error code	Error message	Attributes
	1.	The value of the count parameter must be less or equal to 10000.	1007	The value of the count parameter must be less or equal to [10000] .	count

7.11.2.1 JSON Request structure

The table below describes the structure of the JSON request:

No.	Attribute	type	obligation	description

7.11.2.2 JSON Response structure

The table below describes the structure of the JSON request:

No.	Attribute	type	obligation	Description
1.	serviceName	string	required	Service name. Possible values: <ul style="list-style-type: none"> • NOTIFICATION • DECLARATION • ACCESS_RIGHT • CONTRACT_OBJECT • ORDER • BILL.
2.	statisticName	string	required	Statistic name.
3.	statisticPeriod	DateTime	required	Statistic period. Date format specified to YYYY-MM.
4.	contractModel	string	required	Contract model of object. Possible meanings: <ul style="list-style-type: none"> • BSS - General contract bills. • 2S2S – Two contracts – Two bills. • NONE – No value.
5.	contractType	string	required	Contract type of object. Possible meanings:

No.	Attribute	type	obligation	Description
				<ul style="list-style-type: none"> • SBTS – Household customer. • SKMS – Commercial customer. • NONE - No value.
6.	generatingObjectType	string	required	Generating object type. Possible meanings: <ul style="list-style-type: none"> • G – Generating consumer. • N – Distant generating consumer. • NO-TYPE – No generating object type. • NONE – No value.
7.	meterAccountingType	string	required	Meter accounting type of object. Possible meanings: <ul style="list-style-type: none"> • AUTO – automated. • NON-AUTO – not automated. • NO-METER – no meters. • NONE – no value.
8.	statisticValue	integer	required	Statistic calculated value.

7.11.2.3 Error Response structure

The following table describes the JSON structure in the event of a response error:

No.	Attribute	type	obligation	description
1.	code	number	required	Error code.
2.	text	string(4000)	required	Error message.