

Content

| | | |
|--------|--|-----|
| 1. | Documentation version history | 3 |
| 2. | Preface | 68 |
| 3. | Definitions and abbreviations | 69 |
| 4. | Environments..... | 70 |
| 5. | Suppliers' digital certificates | 71 |
| 6. | Recommendation for API client..... | 71 |
| 6.1 | SYNC..... | 71 |
| 7. | DataHub Gateway API documentation | 78 |
| 7.1 | Declaration controller..... | 78 |
| 7.1.1 | GET /gateway/supplier/v3/get-declaration-data?first={integer}&count={integer}&customerId={string}&objectNumber={string}..... | 78 |
| 7.1.2 | POST /gateway/declaration/reading/list | 85 |
| 7.1.3 | POST /gateway/supplier/send-declaration-data..... | 92 |
| 7.2 | Access right controller | 98 |
| 7.2.1 | POST/gateway/access-right/list..... | 98 |
| 7.2.2 | POST /gateway/access-right | 106 |
| 7.2.3 | POST /gateway/access-right/{accessRightUuid}/cancel | 111 |
| 7.3 | Order controller..... | 113 |
| 7.3.1 | POST/gateway/order/list..... | 113 |
| 7.3.2 | POST/gateway/order/data-hr-15min-mtr-lvl | 118 |
| 7.3.3 | POST/gateway/order/data-hr-15min-obj-lvl..... | 121 |
| 7.3.4 | POST/gateway/order/{orderType} | 125 |
| 7.3.5 | GET/gateway/order/{orderId}/data-hr-15min-obj-lvl | 128 |
| 7.3.6 | GET/gateway/order/{orderId}/data-hr-15min-mtr-lvl | 132 |
| 7.3.7 | GET/gateway/order/{orderId}/bill-2s2s-b2b | 136 |
| 7.3.8 | GET/gateway/order/{orderId}/report-obj | 140 |
| 7.3.9 | GET/gateway/order/{orderId}/bill-bss-b2c | 143 |
| 7.3.10 | GET/gateway/order/{orderId}/bill-bss-b2b | 159 |
| 7.3.11 | GET/gateway/order/{orderId}/count..... | 172 |
| 7.3.12 | POST/gateway/order/data-hr-15min-mtr-lvl-acr | 174 |

| | | |
|--------|---|-----|
| 7.3.13 | POST/gateway/order/data-hr-15min-obj-lvl-acr..... | 178 |
| 7.3.14 | POST/gateway/order/data-sum-obj-lvl-acr..... | 181 |
| 7.3.15 | POST/gateway/order/report-obj-acr..... | 184 |
| 7.3.16 | GET /gateway/order/{orderId}/data-hr-15min-obj-lvl-acr..... | 186 |
| 7.3.17 | GET /gateway/order/{orderId}/data-hr-15min-mtr-lvl-acr..... | 190 |
| 7.3.18 | GET /gateway/order/{orderId}/report-obj-acr..... | 193 |
| 7.3.19 | GET /gateway/order/{orderId}/data-sum-obj-lvl-acr..... | 197 |
| 7.4 | Object controller..... | 201 |
| 7.4.1 | POST /gateway/object/my/active/list..... | 201 |
| 7.4.2 | POST /gateway/object/all/active/list..... | 214 |
| 7.5 | Notification contract controller..... | 223 |
| 7.5.1 | POST /gateway/notification/contract/list..... | 223 |
| 7.5.2 | POST /gateway/notification/contract..... | 236 |
| 7.5.3 | POST /gateway/notification/{notificationId}/contract/cancel..... | 259 |
| 7.6 | Notification contract termination controller..... | 261 |
| 7.6.1 | POST /gateway/notification/contract/termination/list?first={integer}&count={integer}&sortOrder={ASC/DSC}..... | 261 |
| 7.6.2 | POST /gateway/notification/contract/termination..... | 268 |
| 7.6.3 | POST /gateway/notification/{notificationId}/contract/termination/cancel..... | 277 |
| 7.7 | Notification contract object supply state controller..... | 279 |
| 7.7.1 | POST /gateway/notification/contract/object/supply-state/list?first={integer}&count={integer}&sortOrder={ASC/DSC}..... | 279 |
| 7.7.2 | POST /gateway/notification/contract/object/supply-state..... | 287 |
| 7.7.3 | POST /gateway/notification/{notificationId}/contract/object/supply-state/cancel..... | 292 |
| 7.8 | Notification cancellation controller..... | 294 |
| 7.8.1 | POST /gateway/notification/cancellation/list?first={integer}&count={integer}&sortOrder={ASC/DSC}..... | 294 |
| 7.8.2 | POST /gateway/notification/cancellation..... | 300 |
| 7.8.3 | POST /gateway/notification/{notificationId}/cancellation/cancel..... | 305 |
| 7.9 | Notification contract tariff plan controller..... | 307 |
| 7.9.1 | POST /gateway/notification/contract/tarif-plan/list?first={integer}&count={integer}&sortKey={string}&sortOrder={ASC/DSC}..... | 307 |
| 7.9.2 | POST /gateway/notification/contract/tariff-plan..... | 314 |
| 7.9.3 | POST /gateway/notification/{notificationId}/contract/tariff-plan/cancel..... | 322 |

| | | |
|--------|---|-----|
| 7.10 | Notification contract contact controller | 325 |
| 7.10.1 | POST /gateway/notification/contract/contact/list?first={integer}&count={integer}&sortKey={string}&sortOrder={ASC/DSC} | 325 |
| 7.10.2 | POST /gateway/notification/contract/contact..... | 333 |
| 7.10.3 | POST /gateway/notification/{notificationId}/contract/contact/cancel | 340 |
| 7.11 | Report controller | 342 |
| 7.11.1 | POST /reports/accounting-data-pack-b2c?first={integer}&count={integer}..... | 342 |
| 7.11.2 | POST /reports/accounting-data-pack-b2c-count..... | 359 |
| 7.11.3 | POST /reports/accounting-data-pack-b2b-meters-level?first={integer}&count={integer}..... | 361 |
| 7.11.4 | POST /reports/accounting-data-pack-b2b-meters-level-count..... | 375 |
| 7.12 | Access rights controller – <i>will be deprecated in the future, preliminary date – 2023-05-23</i> | 377 |
| 7.12.1 | POST /access-rights/client/data-access-rights..... | 377 |
| 7.12.2 | GET /access-rights/client/granted-objects?first={integer}&count={integer}&sort={ASC/DSC} | 380 |
| 7.12.3 | POST /access-rights/client/data-access-rights/delete..... | 383 |
| 7.13 | Data order controller – <i>will be deprecated in the future, preliminary date – 2023-05-23</i> | 386 |
| 7.13.1 | POST /v2/data/data-orders..... | 386 |
| 7.13.2 | GET /data/data-orders/{orderId}/data | 390 |

1. Documentation version history

The table below provides information on document version history:

| Version | Date | Description |
|---------|------------|--|
| 0.1 | 2019-11-15 | Initial document version. |
| 0.2 | 2019-11-18 | Updated bDHolder Gateway component internet addresses by adding ports. |
| 0.3 | 2019-11-18 | DataHub Sandbox and Production manual. |
| 0.4 | 2020-01-04 | API changes from XML to JSON. |
| 0.5 | 2020-09-07 | Existing documentation changed by adding information about request/response parameters, added fields types and description, explanations, etc. |
| 0.6 | 2020-09-21 | New methods added, existing methods changed by adding personal and company code parameters, customerCode and objectCode fields renamed, other changes. |
| 0.6.1 | 2020-09-22 | <ul style="list-style-type: none"> Existing Supplier change notification method will remain and new method (/supplier/v2/supplier-change-notifications) deployed as version v2; |

| | | |
|-------|------------|--|
| | | <ul style="list-style-type: none"> ○ response JSON model added to both Supplier change notification methods (v1 and v2); ○ new rules explanation added; ○ Some error messages changed; ● /client/client-objects-information method: <ul style="list-style-type: none"> ○ success response code changed from to 201 to 200; ○ changes in method rules table; ○ changes in method error messages table; ● /client/client-objects-information (new) method : <ul style="list-style-type: none"> ○ method was moved to supplier-change-notification controller; ○ response model contractType field will return <i>null</i> till next DataHub API version update; ● POST /client/data-access-rights (new) <ul style="list-style-type: none"> ○ Request structure was changed (object list was removed) ○ Some error messages changed; ● GET /client/granted-objects (new) <ul style="list-style-type: none"> ○ Header count parameter value can be only numbers; ○ Response structure was changed (objects list was removed) ○ Some error messages changed; ● POST /client/data-access-rights/delete (new) <ul style="list-style-type: none"> ○ Request structure was changed (object list and customers list were removed) ○ Some error messages changed; ● Reports controller: <ul style="list-style-type: none"> ○ POST /reports/accounting-data-pack-b2c and POST /reports/objects-data-pack response models changed; ● GET /data/data-orders/{orderId}/data method response changes: <ul style="list-style-type: none"> ○ File Valandiniai <...>.csv - P- field added; ○ File Suminiai <...>.csv - D1, D2, N1, N2 fields added; ○ File Objektai <...>.csv - automation Level field will return new values; |
| 0.6.2 | 2020-10-07 | <p>Added information about Declaration process:</p> <ul style="list-style-type: none"> ● Supplier-change-notification v2 <ul style="list-style-type: none"> ○ One Error code was removed (error code 4 in previous documentation). ● Declaration controller section was created <ul style="list-style-type: none"> ○ Technical description was added: <ul style="list-style-type: none"> ▪ GET /supplier/get-declaration-data - method to get all required data about client to implement declaration process; ▪ POST /supplier/send-declaration-data - method to send clients' declaration data to DSO; |
| 0.6.3 | 2020-10-16 | <p>Added additional information in Declaration GET /supplier/get-declaration-data method data model:</p> |

| | | |
|-------|------------|---|
| | | <ul style="list-style-type: none"> ○ clientId and scaleType information; |
| 0.6.4 | 2020-11-06 | <ul style="list-style-type: none"> • Added response error codes in POST /data/data-orders and GET /data/data-orders/{orderId}/data methods. • GET /supplier/get-declaration-data <ul style="list-style-type: none"> ○ readings[].conversionPoss - changed data type from string to boolean ○ readings[].scales[].readingFromDate - date format specified to YYYY-MM-DDThh:mm:ss • POST /supplier/send-declaration-data <ul style="list-style-type: none"> ○ conversion - changed data type from string to boolean ○ dataWriteDate - date format specified to YYYY-MM-DDThh:mm:ss |
| 0.6.5 | 2020-11-23 | <p>Method supplier-change-notifications: added new error (202 Object number "{objectNumber}" repeats.)</p> <p>Changed URL parameters in methods: added first and count.</p> <ul style="list-style-type: none"> • GET supplier/get-declaration-data • GET client/granted-objects • GET reports/accounting-data-pack-b2b • GET reports/accounting-data-pack-b2b-meters-level • GET reports/accounting-data-pack-b2c • GET reports/objects-data-pack |
| 0.6.6 | 2020-12-08 | New method version POST /reports/accounting-data-pack-b2c added new fields for "Additional component of distribution service" (Sppd). |
| 0.6.7 | 2020-12-08 | <p>In methods POST /reports/accounting-data-pack-b2c, POST /reports/accounting-data-pack-b2b and POST /reports/accounting-data-pack-b2b-meters-level added new fields:</p> <ul style="list-style-type: none"> • AccumulatedUploadedConsumptionAmount; • AccumulatedRaisedConsumptionAmount. <p>Old field AccumulatedTransferredConsumptionAmount will be deleted after the transition period (about 1 month).</p> |
| 0.6.8 | 2021-01-29 | <p>Updated JSON specification of POST /reports/accounting-data-pack-b2b-meters-level method. Added new fields:</p> <ul style="list-style-type: none"> • AccumulatedBeginningConsumptionAmount • AccumulatedEndConsumptionAmount • ConsumedElectricityConsumptionAmount |

- ConsumedElectricityReadingsFrom
- ConsumedElectricityReadingsTo
- ConsumptionConversionActCreateDate
- ConsumptionConversionActFrom
- ConsumptionConversionActNumber
- ConsumptionConversionActTo
- ConsumptionState
- ConsumptionStateFrom
- ConsumptionStateTo
- EnergyObtainedConsumptionAmount
- EnergyObtainedDateFrom
- EnergyObtainedDateTo
- EnergyObtainedPowerKw
- GridSuppliedConsumptionAmount
- GridSuppliedReadingsFrom
- GridSuppliedReadingsTo
- InstalledConsumptionPower
- InstalledGeneratingPower
- PaymentType
- PowerPlantCapacityAmountNoVAT
- PowerPlantCapacityConsumptionAmount
- PowerPlantCapacityDateFrom
- PowerPlantCapacityDateTo
- PowerPlantCapacityPriceEur
- PowerPlantCapacitySource
- PowerPlantCapacitySourceDateFrom
- PowerPlantCapacitySourceDateTo
- PowerPlantCapacityUnit
- ReportingPeriod
- Service

Renamed fields:

- ReadingsSourceTypeCodeDatahub to ReadingsSource
- PermanentHomePlusAmountNoVAT to PermanentHomePlusAmountNoVAT

Removed fields:

- MetersMalfunctionActCreateDate
- MetersMalfunctionActFrom

| | | |
|--------|------------|--|
| | | <ul style="list-style-type: none"> • MetersMalfunctionActNumber • MetersMalfunctionActTo • NotConsumeFrom • NotConsumeTo • TechnologicalCostsReadingsFrom • TechnologicalCostsReadingsTo |
| 0.6.9 | 2021-02-10 | <p>Updated JSON specification of POST /reports/accounting-data-pack-b2b-meters-level method. Added new fields:</p> <ul style="list-style-type: none"> • DdSppdAmountNoVAT • DdSppdConsumptionAmount • DdSppdDiscount • DdSppdPriceEur • DdSppdUnit • MissingEnergySppdAmountNoVAT • MissingEnergySppdConsumptionAmount • MissingEnergySppdDiscount • MissingEnergySppdPriceEur • MissingEnergySppdUnit • NkSppdAmountNoVAT • NkSppdConsumptionAmount • NkSppdDiscount • NkSppdPriceEur • NkSppdUnit • VkSppdAmountNoVAT • VkSppdConsumptionAmount • VkSppdDiscount • VkSppdPriceEur • VkSppdUnit |
| 0.6.10 | 2020-02-15 | <p>Updated JSON specification of POST /reports/accounting-data-pack-b2b-meters-level method. Added new fields:</p> <ul style="list-style-type: none"> • DdDiscountAmountNoVAT • DdDiscountConsumptionAmount • DdDiscountDiscount • DdDiscountPriceEur • DdDiscountUnit • MissingEnergyDiscountAmountNoVAT |

| | | |
|--------|------------|--|
| | | <ul style="list-style-type: none"> • MissingEnergyDiscountConsumptionAmount • MissingEnergyDiscountDiscount • MissingEnergyDiscountPriceEur • MissingEnergyDiscountUnit • NkDiscountAmountNoVAT • NkDiscountConsumptionAmount • NkDiscountDiscount • NkDiscountPriceEur • NkDiscountUnit • VkDiscountAmountNoVAT • VkDiscountConsumptionAmount • VkDiscountDiscount • VkDiscountPriceEur • VkDiscountUnit |
| 0.6.11 | 2021-02-17 | <p>Added additional rules and response errors in:</p> <ul style="list-style-type: none"> ▪ POST /reports/accounting-data-pack-b2c ▪ POST /reports/accounting-data-pack-b2c-count ▪ POST /reports/accounting-data-pack-b2b-meters-level ▪ POST /reports/accounting-data-pack-b2b-meters-level-count ▪ POST /reports/objects-data-pack ▪ POST /reports/objects-data-pack-count ▪ POST /reports/accounting-data-pack-b2b?first={integer}&count={integer} ▪ POST /reports/accounting-data-pack-b2b-count |
| 0.6.12 | 2021-03-03 | <p>Added an additional response error No 13 in:</p> <ul style="list-style-type: none"> ▪ POST /gateway/supplier/send-declaration-data |
| 0.6.13 | 2021-03-05 | <p>Edited the error message rule 8 of the notification creation and the 108 error message text in:</p> <ul style="list-style-type: none"> • POST /supplier/v2/supplier-change-notifications (new) |
| 0.6.14 | 2021-03-12 | <p>Edited the description of the 108 error message</p> <ul style="list-style-type: none"> • POST /supplier/v2/supplier-change-notifications (new) |

| | | |
|--------|------------|---|
| 0.6.15 | 2021-03-15 | <p>Updated JSON specification of POST /reports/accounting-data-pack-b2c method. Added new fields:</p> <ul style="list-style-type: none"> • D1ConsumedElectricityConsumptionAmount • D1ConsumedElectricityReadingsFrom • D1ConsumedElectricityReadingsTo • D1ConsumedElectricityUnit • D1MissingEnergyAmount • D1MissingEnergyAmountNoVAT • D1MissingEnergyConsumptionAmount • D1MissingEnergyIncludedVAT • D1MissingEnergyPriceEur • D1MissingEnergyPriceEurVAT • D1MissingEnergySppdAmount • D1MissingEnergySppdAmountNoVAT • D1MissingEnergySppdConsumptionAmount • D1MissingEnergySppdIncludedVAT • D1MissingEnergySppdPriceEur • D1MissingEnergySppdPriceEurVAT • D1MissingEnergySppdUnit • D1MissingEnergyUnit • D1MissingEnergyViapAmount • D1MissingEnergyViapAmountNoVAT • D1MissingEnergyViapConsumptionAmount • D1MissingEnergyViapIncludedVAT • D1MissingEnergyViapPriceEur • D1MissingEnergyViapPriceEurVAT • D1MissingEnergyViapUnit • D1PayingRecoveredEnergyAmount • D1PayingRecoveredEnergyAmountNoVAT • D1PayingRecoveredEnergyConsumptionAmount • D1PayingRecoveredEnergyIncludedVAT • D1PayingRecoveredEnergyPriceEur • D1PayingRecoveredEnergyPriceEurVAT • D1PayingRecoveredEnergyUnit • D1PayingRecoveredMixedAmount • D1PayingRecoveredMixedAmountNoVAT • D1PayingRecoveredMixedConsumptionAmount • D1PayingRecoveredMixedIncludedVAT • D1PayingRecoveredMixedPriceEur • D1PayingRecoveredMixedPriceEurVAT |
|--------|------------|---|

- D1PayingRecoveredMixedUnit
- D1PayingRecoveredPercentConsumptionAmount
- D1PayingRecoveredPercentUnit
- D1PayingRecoveredPowerConsumptionAmount
- D1PayingRecoveredPowerUnit
- D2ConsumedElectricityConsumptionAmount
- D2ConsumedElectricityReadingsFrom
- D2ConsumedElectricityReadingsTo
- D2ConsumedElectricityUnit
- D2MissingEnergyAmount
- D2MissingEnergyAmountNoVAT
- D2MissingEnergyConsumptionAmount
- D2MissingEnergyIncludedVAT
- D2MissingEnergyPriceEur
- D2MissingEnergyPriceEurVAT
- D2MissingEnergySppdAmount
- D2MissingEnergySppdAmountNoVAT
- D2MissingEnergySppdConsumptionAmount
- D2MissingEnergySppdIncludedVAT
- D2MissingEnergySppdPriceEur
- D2MissingEnergySppdPriceEurVAT
- D2MissingEnergySppdUnit
- D2MissingEnergyUnit
- D2MissingEnergyViapAmount
- D2MissingEnergyViapAmountNoVAT
- D2MissingEnergyViapConsumptionAmount
- D2MissingEnergyViapIncludedVAT
- D2MissingEnergyViapPriceEur
- D2MissingEnergyViapPriceEurVAT
- D2MissingEnergyViapUnit
- D2PayingRecoveredEnergyAmount
- D2PayingRecoveredEnergyAmountNoVAT
- D2PayingRecoveredEnergyConsumptionAmount
- D2PayingRecoveredEnergyIncludedVAT
- D2PayingRecoveredEnergyPriceEur
- D2PayingRecoveredEnergyPriceEurVAT
- D2PayingRecoveredEnergyUnit
- D2PayingRecoveredMixedAmount
- D2PayingRecoveredMixedAmountNoVAT
- D2PayingRecoveredMixedConsumptionAmount
- D2PayingRecoveredMixedIncludedVAT

- D2PayingRecoveredMixedPriceEur
- D2PayingRecoveredMixedPriceEurVAT
- D2PayingRecoveredMixedUnit
- D2PayingRecoveredPercentConsumptionAmount
- D2PayingRecoveredPercentUnit
- D2PayingRecoveredPowerConsumptionAmount
- D2PayingRecoveredPowerUnit
- DdConsumedElectricityConsumptionAmount
- DdConsumedElectricityReadingsFrom
- DdConsumedElectricityReadingsTo
- DdConsumedElectricityUnit
- DdMissingEnergyAmount
- DdMissingEnergyAmountNoVAT
- DdMissingEnergyConsumptionAmount
- DdMissingEnergyIncludedVAT
- DdMissingEnergyPriceEur
- DdMissingEnergyPriceEurVAT
- DdMissingEnergySppdAmount
- DdMissingEnergySppdAmountNoVAT
- DdMissingEnergySppdConsumptionAmount
- DdMissingEnergySppdIncludedVAT
- DdMissingEnergySppdPriceEur
- DdMissingEnergySppdPriceEurVAT
- DdMissingEnergySppdUnit
- DdMissingEnergyUnit
- DdMissingEnergyViapAmount
- DdMissingEnergyViapAmountNoVAT
- DdMissingEnergyViapConsumptionAmount
- DdMissingEnergyViapIncludedVAT
- DdMissingEnergyViapPriceEur
- DdMissingEnergyViapPriceEurVAT
- DdMissingEnergyViapUnit
- DdPayingRecoveredEnergyAmount
- DdPayingRecoveredEnergyAmountNoVAT
- DdPayingRecoveredEnergyConsumptionAmount
- DdPayingRecoveredEnergyIncludedVAT
- DdPayingRecoveredEnergyPriceEur
- DdPayingRecoveredEnergyPriceEurVAT
- DdPayingRecoveredEnergyUnit
- DdPayingRecoveredMixedAmount
- DdPayingRecoveredMixedAmountNoVAT

- DdPayingRecoveredMixedConsumptionAmount
- DdPayingRecoveredMixedIncludedVAT
- DdPayingRecoveredMixedPriceEur
- DdPayingRecoveredMixedPriceEurVAT
- DdPayingRecoveredMixedUnit
- DdPayingRecoveredPercentConsumptionAmount
- DdPayingRecoveredPercentUnit
- DdPayingRecoveredPowerConsumptionAmount
- DdPayingRecoveredPowerUnit
- N1ConsumedElectricityConsumptionAmount
- N1ConsumedElectricityReadingsFrom
- N1ConsumedElectricityReadingsTo
- N1ConsumedElectricityUnit
- N1MissingEnergyAmount
- N1MissingEnergyAmountNoVAT
- N1MissingEnergyConsumptionAmount
- N1MissingEnergyIncludedVAT
- N1MissingEnergyPriceEur
- N1MissingEnergyPriceEurVAT
- N1MissingEnergySppdAmount
- N1MissingEnergySppdAmountNoVAT
- N1MissingEnergySppdConsumptionAmount
- N1MissingEnergySppdIncludedVAT
- N1MissingEnergySppdPriceEur
- N1MissingEnergySppdPriceEurVAT
- N1MissingEnergySppdUnit
- N1MissingEnergyUnit
- N1MissingEnergyViapAmount
- N1MissingEnergyViapAmountNoVAT
- N1MissingEnergyViapConsumptionAmount
- N1MissingEnergyViapIncludedVAT
- N1MissingEnergyViapPriceEur
- N1MissingEnergyViapPriceEurVAT
- N1MissingEnergyViapUnit
- N1PayingRecoveredEnergyAmount
- N1PayingRecoveredEnergyAmountNoVAT
- N1PayingRecoveredEnergyConsumptionAmount
- N1PayingRecoveredEnergyIncludedVAT
- N1PayingRecoveredEnergyPriceEur
- N1PayingRecoveredEnergyPriceEurVAT
- N1PayingRecoveredEnergyUnit

- N1PayingRecoveredMixedAmount
- N1PayingRecoveredMixedAmountNoVAT
- N1PayingRecoveredMixedConsumptionAmount
- N1PayingRecoveredMixedIncludedVAT
- N1PayingRecoveredMixedPriceEur
- N1PayingRecoveredMixedPriceEurVAT
- N1PayingRecoveredMixedUnit
- N1PayingRecoveredPercentConsumptionAmount
- N1PayingRecoveredPercentUnit
- N1PayingRecoveredPowerConsumptionAmount
- N1PayingRecoveredPowerUnit
- N2ConsumedElectricityConsumptionAmount
- N2ConsumedElectricityReadingsFrom
- N2ConsumedElectricityReadingsTo
- N2ConsumedElectricityUnit
- N2MissingEnergyAmount
- N2MissingEnergyAmountNoVAT
- N2MissingEnergyConsumptionAmount
- N2MissingEnergyIncludedVAT
- N2MissingEnergyPriceEur
- N2MissingEnergyPriceEurVAT
- N2MissingEnergySppdAmount
- N2MissingEnergySppdAmountNoVAT
- N2MissingEnergySppdConsumptionAmount
- N2MissingEnergySppdIncludedVAT
- N2MissingEnergySppdPriceEur
- N2MissingEnergySppdPriceEurVAT
- N2MissingEnergySppdUnit
- N2MissingEnergyUnit
- N2MissingEnergyViapAmount
- N2MissingEnergyViapAmountNoVAT
- N2MissingEnergyViapConsumptionAmount
- N2MissingEnergyViapIncludedVAT
- N2MissingEnergyViapPriceEur
- N2MissingEnergyViapPriceEurVAT
- N2MissingEnergyViapUnit
- N2PayingRecoveredEnergyAmount
- N2PayingRecoveredEnergyAmountNoVAT
- N2PayingRecoveredEnergyConsumptionAmount
- N2PayingRecoveredEnergyIncludedVAT
- N2PayingRecoveredEnergyPriceEur

- N2PayingRecoveredEnergyPriceEurVAT
- N2PayingRecoveredEnergyUnit
- N2PayingRecoveredMixedAmount
- N2PayingRecoveredMixedAmountNoVAT
- N2PayingRecoveredMixedConsumptionAmount
- N2PayingRecoveredMixedIncludedVAT
- N2PayingRecoveredMixedPriceEur
- N2PayingRecoveredMixedPriceEurVAT
- N2PayingRecoveredMixedUnit
- N2PayingRecoveredPercentConsumptionAmount
- N2PayingRecoveredPercentUnit
- N2PayingRecoveredPowerConsumptionAmount
- N2PayingRecoveredPowerUnit
- NkConsumedElectricityConsumptionAmount
- NkConsumedElectricityReadingsFrom
- NkConsumedElectricityReadingsTo
- NkConsumedElectricityUnit
- NkMissingEnergyAmount
- NkMissingEnergyAmountNoVAT
- NkMissingEnergyConsumptionAmount
- NkMissingEnergyIncludedVAT
- NkMissingEnergyPriceEur
- NkMissingEnergyPriceEurVAT
- NkMissingEnergySppdAmount
- NkMissingEnergySppdAmountNoVAT
- NkMissingEnergySppdConsumptionAmount
- NkMissingEnergySppdIncludedVAT
- NkMissingEnergySppdPriceEur
- NkMissingEnergySppdPriceEurVAT
- NkMissingEnergySppdUnit
- NkMissingEnergyUnit
- NkMissingEnergyViapAmount
- NkMissingEnergyViapAmountNoVAT
- NkMissingEnergyViapConsumptionAmount
- NkMissingEnergyViapIncludedVAT
- NkMissingEnergyViapPriceEur
- NkMissingEnergyViapPriceEurVAT
- NkMissingEnergyViapUnit
- NkPayingRecoveredEnergyAmount
- NkPayingRecoveredEnergyAmountNoVAT
- NkPayingRecoveredEnergyConsumptionAmount

- NkPayingRecoveredEnergyIncludedVAT
- NkPayingRecoveredEnergyPriceEur
- NkPayingRecoveredEnergyPriceEurVAT
- NkPayingRecoveredEnergyUnit
- NkPayingRecoveredMixedAmount
- NkPayingRecoveredMixedAmountNoVAT
- NkPayingRecoveredMixedConsumptionAmount
- NkPayingRecoveredMixedIncludedVAT
- NkPayingRecoveredMixedPriceEur
- NkPayingRecoveredMixedPriceEurVAT
- NkPayingRecoveredMixedUnit
- NkPayingRecoveredPercentConsumptionAmount
- NkPayingRecoveredPercentUnit
- NkPayingRecoveredPowerConsumptionAmount
- NkPayingRecoveredPowerUnit

Renamed fields (added Vk prefix):

- VkConsumedElectricityConsumptionAmount
- VkConsumedElectricityReadingsFrom
- VkConsumedElectricityReadingsTo
- VkConsumedElectricityUnit
- VkMissingEnergyAmount
- VkMissingEnergyAmountNoVAT
- VkMissingEnergyConsumptionAmount
- VkMissingEnergyDiscount
- VkMissingEnergyIncludedVAT
- VkMissingEnergyPriceEur
- VkMissingEnergyPriceEurVAT
- VkMissingEnergySppdAmount
- VkMissingEnergySppdAmountNoVAT
- VkMissingEnergySppdConsumptionAmount
- VkMissingEnergySppdDiscount
- VkMissingEnergySppdIncludedVAT
- VkMissingEnergySppdPriceEur
- VkMissingEnergySppdPriceEurVAT
- VkMissingEnergySppdUnit
- VkMissingEnergyUnit
- VkMissingEnergyViapAmount
- VkMissingEnergyViapAmountNoVAT

| | | |
|--------|------------|---|
| | | <ul style="list-style-type: none"> • VkMissingEnergyViapConsumptionAmount • VkMissingEnergyViapDiscount • VkMissingEnergyViapIncludedVAT • VkMissingEnergyViapPriceEur • VkMissingEnergyViapPriceEurVAT • VkMissingEnergyViapUnit • VkPayingRecoveredEnergyAmount • VkPayingRecoveredEnergyAmountNoVAT • VkPayingRecoveredEnergyConsumptionAmount • VkPayingRecoveredEnergyDiscount • VkPayingRecoveredEnergyIncludedVAT • VkPayingRecoveredEnergyPriceEur • VkPayingRecoveredEnergyPriceEurVAT • VkPayingRecoveredEnergyUnit • VkPayingRecoveredMixedAmount • VkPayingRecoveredMixedAmountNoVAT • VkPayingRecoveredMixedConsumptionAmount • VkPayingRecoveredMixedDiscount • VkPayingRecoveredMixedIncludedVAT • VkPayingRecoveredMixedPriceEur • VkPayingRecoveredMixedPriceEurVAT • VkPayingRecoveredMixedUnit • VkPayingRecoveredPercentConsumptionAmount • VkPayingRecoveredPercentUnit • VkPayingRecoveredPowerConsumptionAmount • VkPayingRecoveredPowerUnit |
| 0.6.16 | 2021-03-16 | <p>Updated JSON specification of POST /reports/accounting-data-pack-b2b-meters-level method. Added new fields:</p> <ul style="list-style-type: none"> • DdConsumedElectricityConsumptionAmount • DdConsumedElectricityUnit • DdConsumedElectricityReadingsFrom • DdConsumedElectricityReadingsTo • NkConsumedElectricityConsumptionAmount • NkConsumedElectricityUnit • NkConsumedElectricityReadingsFrom • NkConsumedElectricityReadingsTo • MaConsumedElectricityConsumptionAmount • MaConsumedElectricityUnit • MaConsumedElectricityReadingsFrom |

- MaConsumedElectricityReadingsTo
- VdConsumedElectricityConsumptionAmount
- VdConsumedElectricityUnit
- VdConsumedElectricityReadingsFrom
- VdConsumedElectricityReadingsTo
- SvConsumedElectricityConsumptionAmount
- SvConsumedElectricityUnit
- SvConsumedElectricityReadingsFrom
- SvConsumedElectricityReadingsTo
- MiConsumedElectricityConsumptionAmount
- MiConsumedElectricityUnit
- MiConsumedElectricityReadingsFrom
- MiConsumedElectricityReadingsTo
- DdPayingRecoveredEnergyConsumptionAmount
- DdPayingRecoveredEnergyUnit
- DdPayingRecoveredEnergyPriceEur
- DdPayingRecoveredEnergyAmountNoVAT
- NkPayingRecoveredEnergyConsumptionAmount
- NkPayingRecoveredEnergyUnit
- NkPayingRecoveredEnergyPriceEur
- NkPayingRecoveredEnergyAmountNoVAT
- MaPayingRecoveredEnergyConsumptionAmount
- MaPayingRecoveredEnergyUnit
- MaPayingRecoveredEnergyPriceEur
- MaPayingRecoveredEnergyAmountNoVAT
- VdPayingRecoveredEnergyConsumptionAmount
- VdPayingRecoveredEnergyUnit
- VdPayingRecoveredEnergyPriceEur
- VdPayingRecoveredEnergyAmountNoVAT
- SvPayingRecoveredEnergyConsumptionAmount
- SvPayingRecoveredEnergyUnit
- SvPayingRecoveredEnergyPriceEur
- SvPayingRecoveredEnergyAmountNoVAT
- MiPayingRecoveredEnergyConsumptionAmount
- MiPayingRecoveredEnergyUnit
- MiPayingRecoveredEnergyPriceEur
- MiPayingRecoveredEnergyAmountNoVAT
- DdPayingRecoveredPercentConsumptionAmount
- DdPayingRecoveredPercentUnit
- NkPayingRecoveredPercentConsumptionAmount
- NkPayingRecoveredPercentUnit

- MaPayingRecoveredPercentConsumptionAmount
- MaPayingRecoveredPercentUnit
- VdPayingRecoveredPercentConsumptionAmount
- VdPayingRecoveredPercentUnit
- SvPayingRecoveredPercentConsumptionAmount
- SvPayingRecoveredPercentUnit
- MiPayingRecoveredPercentConsumptionAmount
- MiPayingRecoveredPercentUnit
- DdPayingRecoveredPowerConsumptionAmount
- DdPayingRecoveredPowerUnit
- NkPayingRecoveredPowerConsumptionAmount
- NkPayingRecoveredPowerUnit
- MaPayingRecoveredPowerConsumptionAmount
- MaPayingRecoveredPowerUnit
- VdPayingRecoveredPowerConsumptionAmount
- VdPayingRecoveredPowerUnit
- SvPayingRecoveredPowerConsumptionAmount
- SvPayingRecoveredPowerUnit
- MiPayingRecoveredPowerConsumptionAmount
- MiPayingRecoveredPowerUnit
- DdPayingRecoveredMixedConsumptionAmount
- DdPayingRecoveredMixedUnit
- DdPayingRecoveredMixedPriceEur
- DdPayingRecoveredMixedAmountNoVAT
- NkPayingRecoveredMixedConsumptionAmount
- NkPayingRecoveredMixedUnit
- NkPayingRecoveredMixedPriceEur
- NkPayingRecoveredMixedAmountNoVAT
- MaPayingRecoveredMixedConsumptionAmount
- MaPayingRecoveredMixedUnit
- MaPayingRecoveredMixedPriceEur
- MaPayingRecoveredMixedAmountNoVAT
- VdPayingRecoveredMixedConsumptionAmount
- VdPayingRecoveredMixedUnit
- VdPayingRecoveredMixedPriceEur
- VdPayingRecoveredMixedAmountNoVAT
- SvPayingRecoveredMixedConsumptionAmount
- SvPayingRecoveredMixedUnit
- SvPayingRecoveredMixedPriceEur
- SvPayingRecoveredMixedAmountNoVAT
- MiPayigRecoveredMixedConsumptionAmount

- MiPayingRecoveredMixedUnit
- MiPayingRecoveredMixedPriceEur
- MiPayingRecoveredMixedAmountNoVAT
- DdMissingEnergyConsumptionAmount
- DdMissingEnergyUnit
- DdMissingEnergyPriceEur
- DdMissingEnergyAmountNoVAT
- NkMissingEnergyConsumptionAmount
- NkMissingEnergyUnit
- NkMissingEnergyPriceEur
- NkMissingEnergyAmountNoVAT
- MaMissingEnergyConsumptionAmount
- MaMissingEnergyUnit
- MaMissingEnergyPriceEur
- MaMissingEnergyAmountNoVAT
- VdMissingEnergyConsumptionAmount
- VdMissingEnergyUnit
- VdMissingEnergyPriceEur
- VdMissingEnergyAmountNoVAT
- SvMissingEnergyConsumptionAmount
- SvMissingEnergyUnit
- SvMissingEnergyPriceEur
- SvMissingEnergyAmountNoVAT
- MiMissingEnergyConsumptionAmount
- MiMissingEnergyUnit
- MiMissingEnergyPriceEur
- MiMissingEnergyAmountNoVAT
- DdMissingEnergyViapConsumptionAmount
- DdMissingEnergyViapUnit
- DdMissingEnergyViapPriceEur
- DdMissingEnergyViapAmountNoVAT
- NkMissingEnergyViapConsumptionAmount
- NkMissingEnergyViapUnit
- NkMissingEnergyViapPriceEur
- NkMissingEnergyViapAmountNoVAT
- MaMissingEnergyViapConsumptionAmount
- MaMissingEnergyViapUnit
- MaMissingEnergyViapPriceEur
- MaMissingEnergyViapAmountNoVAT
- VdMissingEnergyViapConsumptionAmount
- VdMissingEnergyViapUnit

- VdMissingEnergyViapPriceEur
- VdMissingEnergyViapAmountNoVAT
- SvMissingEnergyViapConsumptionAmount
- SvMissingEnergyViapUnit
- SvMissingEnergyViapPriceEur
- SvMissingEnergyViapAmountNoVAT
- MiMissingEnergyViapConsumptionAmount
- MiMissingEnergyViapUnit
- MiMissingEnergyViapPriceEur
- MiMissingEnergyViapAmountNoVAT
- DdMissingEnergySppdConsumptionAmount
- DdMissingEnergySppdUnit
- DdMissingEnergySppdPriceEur
- DdMissingEnergySppdAmountNoVAT
- NkMissingEnergySppdConsumptionAmount
- NkMissingEnergySppdUnit
- NkMissingEnergySppdPriceEur
- NkMissingEnergySppdAmountNoVAT
- DdMissingEnergyDiscountConsumptionAmount
- DdMissingEnergyDiscountUnit
- DdMissingEnergyDiscountPriceEur
- DdMissingEnergyDiscountAmountNoVAT
- NkMissingEnergyDiscountConsumptionAmount
- NkMissingEnergyDiscountUnit
- NkMissingEnergyDiscountPriceEur
- NkMissingEnergyDiscountAmountNoVAT

Renamed fields (added Vk prefix):

- VkConsumedElectricityConsumptionAmount
- VkConsumedElectricityUnit
- VkConsumedElectricityReadingsFrom
- VkConsumedElectricityReadingsTo
- VkPayingRecoveredEnergyConsumptionAmount
- VkPayingRecoveredEnergyUnit
- VkPayingRecoveredEnergyPriceEur
- VkPayingRecoveredEnergyDiscount
- VkPayingRecoveredEnergyAmountNoVAT
- VkPayingRecoveredPercentConsumptionAmount
- VkPayingRecoveredPercentUnit

| | | |
|--------|------------|---|
| | | <ul style="list-style-type: none"> • VkPayingRecoveredPowerConsumptionAmount • VkPayingRecoveredPowerUnit • VkPayingRecoveredMixedConsumptionAmount • VkPayingRecoveredMixedUnit • VkPayingRecoveredMixedPriceEur • VkPayingRecoveredMixedDiscount • VkPayingRecoveredMixedAmountNoVAT • VkMissingEnergyConsumptionAmount • VkMissingEnergyUnit • VkMissingEnergyPriceEur • VkMissingEnergyDiscount • VkMissingEnergyAmountNoVAT • VkMissingEnergyViapConsumptionAmount • VkMissingEnergyViapUnit • VkMissingEnergyViapPriceEur • VkMissingEnergyViapDiscount • VkMissingEnergyViapAmountNoVAT • VkMissingEnergySppdConsumptionAmount • VkMissingEnergySppdUnit • VkMissingEnergySppdPriceEur • VkMissingEnergySppdDiscount • VkMissingEnergySppdAmountNoVAT • VkMissingEnergyDiscountConsumptionAmount • VkMissingEnergyDiscountUnit • VkMissingEnergyDiscountPriceEur • VkMissingEnergyDiscountDiscount • VkMissingEnergyDiscountAmountNoVAT |
| 0.6.17 | 2021-03-17 | <p>Supplemented 11 rule and 9 response error in:</p> <ul style="list-style-type: none"> ▪ POST /gateway/supplier/send-declaration-data |
| 0.6.18 | 2021-03-22 | <p>Added new method:</p> <ul style="list-style-type: none"> ▪ GET /gateway/supplier/v3/get-declaration-data?first={integer}&count={integer}&customerId={string}&objectNumber={string} |
| 0.6.19 | 2021-03-23 | <p>Added the new error message 44 and edited rule description 4</p> |

| | | |
|--------|------------|--|
| | | <ul style="list-style-type: none"> • POST /supplier/v2/supplier-change-notifications (new) |
| 0.6.20 | 2021-03-25 | <p>Added the new 9 error message and a new 2 rule description</p> <ul style="list-style-type: none"> • POST /data/data-orders |
| 0.6.21 | 2021-04-06 | <p>Added 423 rule and description in:</p> <ul style="list-style-type: none"> • POST /reports/accounting-data-pack-b2c • POST /reports/accounting-data-pack-b2c-count • POST /reports/accounting-data-pack-b2b-meters-level • POST /reports/accounting-data-pack-b2b-meters-level-count • POST /reports/objects-data-pack • POST /reports/objects-data-pack-count • POST /reports/accounting-data-pack-b2b?first={integer}&count={integer} • POST /reports/accounting-data-pack-b2b-count |
| 0.6.22 | 2021-04-06 | <p>(will be deployed in next sprint) Added the description of the first rule.</p> <ul style="list-style-type: none"> • POST /gateway/supplier/send-declaration-data |
| 0.6.23 | 2021-04-13 | <p>Updated JSON specification of POST /reports/accounting-data-pack-b2c method and POST /reports/accounting-data-pack-b2b-meters-level method. Added new fields:</p> <ul style="list-style-type: none"> ▪ CompensatedConsumptionAmount ▪ OldIndependentSupplier |
| 0.6.24 | 2021-04-21 | <p>Updated JSON specification of POST /reports/accounting-data-pack-b2c method.</p> <p>Changed json fields ordering:</p> <ul style="list-style-type: none"> • CustomerID • ClientID • ClientName • ClientAddress • ObjectID • ObjectNumber • ObjectName • ObjectType |

- ObjectAddress
- AgreementType
- AgreementModel
- AgreementFrom
- AgreementTo
- PermittablePowerConsumption
- PermittablePowerGeneration
- InstalledGeneratingPower
- InstalledConsumptionPower
- MetersAmount
- AutoMetersAmount
- ReportingPeriod
- BillingPeriod
- SupplyState
- SupplyStateFrom
- SupplyStateTo
- MetersNumber
- ReadingsSource
- ReadingsReceiveDate
- PaymentType
- Service
- DeclarationReferenceType
- ReferenceSubmitDate
- ReadingsSubmitDate
- DeclarationReferenceNumber
- UnaccountedConsumptionActNumber
- UnaccountedConsumptionActCreateDate
- UnaccountedConsumptionActFrom
- UnaccountedConsumptionActTo
- ConsumptionConversionActNumber
- ConsumptionConversionActCreateDate
- ConsumptionConversionActFrom
- ConsumptionConversionActTo
- ConsumptionState
- ConsumptionStateFrom
- ConsumptionStateTo
- TariffPlan
- TariffPlanChangeDate
- ConsumptionConversionAct
- PowerPlantCapacityDateFrom
- EnergyObtainedDateFrom

- PowerPlantCapacityDateTo
- EnergyObtainedDateTo
- EnergyObtainedPowerKw
- OperatorGridElectricityPercent
- ClientGridElectricityPercent
- VkConsumptionAmount
- VkViapConsumptionAmount
- VkSppdConsumptionAmount
- DdConsumptionAmount
- DdViapConsumptionAmount
- DdSppdConsumptionAmount
- NkConsumptionAmount
- NkViapConsumptionAmount
- NkSppdConsumptionAmount
- N2ConsumptionAmount
- N2ViapConsumptionAmount
- N2SppdConsumptionAmount
- D1ConsumptionAmount
- D1ViapConsumptionAmount
- D1SppdConsumptionAmount
- D2ConsumptionAmount
- D2ViapConsumptionAmount
- D2SppdConsumptionAmount
- N1ConsumptionAmount
- N1ViapConsumptionAmount
- N1SppdConsumptionAmount
- VkConsumedElectricityConsumptionAmount
- DdConsumedElectricityConsumptionAmount
- NkConsumedElectricityConsumptionAmount
- N2ConsumedElectricityConsumptionAmount
- D1ConsumedElectricityConsumptionAmount
- D2ConsumedElectricityConsumptionAmount
- N1ConsumedElectricityConsumptionAmount
- VkPayingRecoveredEnergyConsumptionAmount
- DdPayingRecoveredEnergyConsumptionAmount
- NkPayingRecoveredEnergyConsumptionAmount
- N2PayingRecoveredEnergyConsumptionAmount
- D1PayingRecoveredEnergyConsumptionAmount
- D2PayingRecoveredEnergyConsumptionAmount
- N1PayingRecoveredEnergyConsumptionAmount
- VkPayingRecoveredPercentConsumptionAmount

- DdPayingRecoveredPercentConsumptionAmount
- NkPayingRecoveredPercentConsumptionAmount
- N2PayingRecoveredPercentConsumptionAmount
- D1PayingRecoveredPercentConsumptionAmount
- D2PayingRecoveredPercentConsumptionAmount
- N1PayingRecoveredPercentConsumptionAmount
- VkPayingRecoveredPowerConsumptionAmount
- DdPayingRecoveredPowerConsumptionAmount
- NkPayingRecoveredPowerConsumptionAmount
- N2PayingRecoveredPowerConsumptionAmount
- D1PayingRecoveredPowerConsumptionAmount
- D2PayingRecoveredPowerConsumptionAmount
- N1PayingRecoveredPowerConsumptionAmount
- VkPayingRecoveredMixedConsumptionAmount
- DdPayingRecoveredMixedConsumptionAmount
- NkPayingRecoveredMixedConsumptionAmount
- N2PayingRecoveredMixedConsumptionAmount
- D1PayingRecoveredMixedConsumptionAmount
- D2PayingRecoveredMixedConsumptionAmount
- N1PayingRecoveredMixedConsumptionAmount
- VkMissingEnergyConsumptionAmount
- VkMissingEnergyViapConsumptionAmount
- VkMissingEnergySppdConsumptionAmount
- DdMissingEnergyConsumptionAmount
- DdMissingEnergyViapConsumptionAmount
- DdMissingEnergySppdConsumptionAmount
- NkMissingEnergyConsumptionAmount
- NkMissingEnergyViapConsumptionAmount
- NkMissingEnergySppdConsumptionAmount
- N2MissingEnergyConsumptionAmount
- N2MissingEnergyViapConsumptionAmount
- N2MissingEnergySppdConsumptionAmount
- D1MissingEnergyConsumptionAmount
- D1MissingEnergyViapConsumptionAmount
- D1MissingEnergySppdConsumptionAmount
- D2MissingEnergyConsumptionAmount
- D2MissingEnergyViapConsumptionAmount
- D2MissingEnergySppdConsumptionAmount
- N1MissingEnergyConsumptionAmount
- N1MissingEnergyViapConsumptionAmount
- N1MissingEnergySppdConsumptionAmount

- GridSuppliedConsumptionAmount
- AccumulatedBeginningConsumptionAmount
- AccumulatedEndConsumptionAmount
- AccumulatedTransferredConsumptionAmount
- AccumulatedUploadedConsumptionAmount
- AccumulatedRaisedConsumptionAmount
- CompensatedConsumptionAmount
- OldIndependentSupplier
- PowerPlantCapacityConsumptionAmount
- EnergyObtainedConsumptionAmount
- OperatorGridElectricityConsumptionAmount
- ClientGridElectricityConsumptionAmount
- VkUnit
- VkViapUnit
- VkSppdUnit
- DdUnit
- DdViapUnit
- DdSppdUnit
- NkUnit
- NkViapUnit
- NkSppdUnit
- N2Unit
- N2ViapUnit
- N2SppdUnit
- D1Unit
- D1ViapUnit
- D1SppdUnit
- D2Unit
- D2ViapUnit
- D2SppdUnit
- N1Unit
- N1ViapUnit
- N1SppdUnit
- VkConsumedElectricityUnit
- DdConsumedElectricityUnit
- NkConsumedElectricityUnit
- N2ConsumedElectricityUnit
- D1ConsumedElectricityUnit
- D2ConsumedElectricityUnit
- N1ConsumedElectricityUnit
- VkPayingRecoveredEnergyUnit

- DdPayingRecoveredEnergyUnit
- NkPayingRecoveredEnergyUnit
- N2PayingRecoveredEnergyUnit
- D1PayingRecoveredEnergyUnit
- D2PayingRecoveredEnergyUnit
- N1PayingRecoveredEnergyUnit
- VkPayingRecoveredPercentUnit
- DdPayingRecoveredPercentUnit
- NkPayingRecoveredPercentUnit
- N2PayingRecoveredPercentUnit
- D1PayingRecoveredPercentUnit
- D2PayingRecoveredPercentUnit
- N1PayingRecoveredPercentUnit
- VkPayingRecoveredPowerUnit
- DdPayingRecoveredPowerUnit
- NkPayingRecoveredPowerUnit
- N2PayingRecoveredPowerUnit
- D1PayingRecoveredPowerUnit
- D2PayingRecoveredPowerUnit
- N1PayingRecoveredPowerUnit
- VkPayingRecoveredMixedUnit
- DdPayingRecoveredMixedUnit
- NkPayingRecoveredMixedUnit
- N2PayingRecoveredMixedUnit
- D1PayingRecoveredMixedUnit
- D2PayingRecoveredMixedUnit
- N1PayingRecoveredMixedUnit
- VkMissingEnergyUnit
- VkMissingEnergyViapUnit
- VkMissingEnergySppdUnit
- DdMissingEnergyUnit
- DdMissingEnergyViapUnit
- DdMissingEnergySppdUnit
- NkMissingEnergyUnit
- NkMissingEnergyViapUnit
- NkMissingEnergySppdUnit
- N2MissingEnergyUnit
- N2MissingEnergyViapUnit
- N2MissingEnergySppdUnit
- D1MissingEnergyUnit
- D1MissingEnergyViapUnit

- D1MissingEnergySppdUnit
- D2MissingEnergyUnit
- D2MissingEnergyViapUnit
- D2MissingEnergySppdUnit
- N1MissingEnergyUnit
- N1MissingEnergyViapUnit
- N1MissingEnergySppdUnit
- VkReadingsFrom
- DdReadingsFrom
- NkReadingsFrom
- N2ReadingsFrom
- D1ReadingsFrom
- D2ReadingsFrom
- N1ReadingsFrom
- VkConsumedElectricityReadingsFrom
- DdConsumedElectricityReadingsFrom
- NkConsumedElectricityReadingsFrom
- N2ConsumedElectricityReadingsFrom
- D1ConsumedElectricityReadingsFrom
- D2ConsumedElectricityReadingsFrom
- N1ConsumedElectricityReadingsFrom
- GridSuppliedReadingsFrom
- VkReadingsTo
- DdReadingsTo
- NkReadingsTo
- N2ReadingsTo
- D1ReadingsTo
- D2ReadingsTo
- N1ReadingsTo
- VkConsumedElectricityReadingsTo
- DdConsumedElectricityReadingsTo
- NkConsumedElectricityReadingsTo
- N2ConsumedElectricityReadingsTo
- D1ConsumedElectricityReadingsTo
- D2ConsumedElectricityReadingsTo
- N1ConsumedElectricityReadingsTo
- GridSuppliedReadingsTo
- VkPriceEur
- VkViapPriceEur
- VkSppdPriceEur
- DdPriceEur

- DdViapPriceEur
- DdSppdPriceEur
- NkPriceEur
- NkViapPriceEur
- NkSppdPriceEur
- N2PriceEur
- N2ViapPriceEur
- N2SppdPriceEur
- D1PriceEur
- D1ViapPriceEur
- D1SppdPriceEur
- D2PriceEur
- D2ViapPriceEur
- D2SppdPriceEur
- N1PriceEur
- N1ViapPriceEur
- N1SppdPriceEur
- VkPayingRecoveredEnergyPriceEur
- DdPayingRecoveredEnergyPriceEur
- NkPayingRecoveredEnergyPriceEur
- N2PayingRecoveredEnergyPriceEur
- D1PayingRecoveredEnergyPriceEur
- D2PayingRecoveredEnergyPriceEur
- N1PayingRecoveredEnergyPriceEur
- VkPayingRecoveredMixedPriceEur
- DdPayingRecoveredMixedPriceEur
- NkPayingRecoveredMixedPriceEur
- N2PayingRecoveredMixedPriceEur
- D1PayingRecoveredMixedPriceEur
- D2PayingRecoveredMixedPriceEur
- N1PayingRecoveredMixedPriceEur
- VkMissingEnergyPriceEur
- VkMissingEnergyViapPriceEur
- VkMissingEnergySppdPriceEur
- DdMissingEnergyPriceEur
- DdMissingEnergyViapPriceEur
- DdMissingEnergySppdPriceEur
- NkMissingEnergyPriceEur
- NkMissingEnergyViapPriceEur
- NkMissingEnergySppdPriceEur
- N2MissingEnergyPriceEur

- N2MissingEnergyViapPriceEur
- N2MissingEnergySppdPriceEur
- D1MissingEnergyPriceEur
- D1MissingEnergyViapPriceEur
- D1MissingEnergySppdPriceEur
- D2MissingEnergyPriceEur
- D2MissingEnergyViapPriceEur
- D2MissingEnergySppdPriceEur
- N1MissingEnergyPriceEur
- N1MissingEnergyViapPriceEur
- N1MissingEnergySppdPriceEur
- PowerPlantCapacityPriceEur
- VkPriceEurVAT
- VkViapPriceEurVAT
- VkSppdPriceEurVAT
- DdPriceEurVAT
- DdViapPriceEurVAT
- DdSppdPriceEurVAT
- NkPriceEurVAT
- NkViapPriceEurVAT
- NkSppdPriceEurVAT
- N2PriceEurVAT
- N2ViapPriceEurVAT
- N2SppdPriceEurVAT
- D1PriceEurVAT
- D1ViapPriceEurVAT
- D1SppdPriceEurVAT
- D2PriceEurVAT
- D2ViapPriceEurVAT
- D2SppdPriceEurVAT
- N1PriceEurVAT
- N1ViapPriceEurVAT
- N1SppdPriceEurVAT
- VkPayingRecoveredEnergyPriceEurVAT
- DdPayingRecoveredEnergyPriceEurVAT
- NkPayingRecoveredEnergyPriceEurVAT
- N2PayingRecoveredEnergyPriceEurVAT
- D1PayingRecoveredEnergyPriceEurVAT
- D2PayingRecoveredEnergyPriceEurVAT
- N1PayingRecoveredEnergyPriceEurVAT
- VkPayingRecoveredMixedPriceEurVAT

- DdPayingRecoveredMixedPriceEurVAT
- NkPayingRecoveredMixedPriceEurVAT
- N2PayingRecoveredMixedPriceEurVAT
- D1PayingRecoveredMixedPriceEurVAT
- D2PayingRecoveredMixedPriceEurVAT
- N1PayingRecoveredMixedPriceEurVAT
- VkMissingEnergyPriceEurVAT
- VkMissingEnergyViapPriceEurVAT
- VkMissingEnergySppdPriceEurVAT
- DdMissingEnergyPriceEurVAT
- DdMissingEnergyViapPriceEurVAT
- DdMissingEnergySppdPriceEurVAT
- NkMissingEnergyPriceEurVAT
- NkMissingEnergyViapPriceEurVAT
- NkMissingEnergySppdPriceEurVAT
- N2MissingEnergyPriceEurVAT
- N2MissingEnergyViapPriceEurVAT
- N2MissingEnergySppdPriceEurVAT
- D1MissingEnergyPriceEurVAT
- D1MissingEnergyViapPriceEurVAT
- D1MissingEnergySppdPriceEurVAT
- D2MissingEnergyPriceEurVAT
- D2MissingEnergyViapPriceEurVAT
- D2MissingEnergySppdPriceEurVAT
- N1MissingEnergyPriceEurVAT
- N1MissingEnergyViapPriceEurVAT
- N1MissingEnergySppdPriceEurVAT
- PowerPlantCapacityPriceEurVat
- VkDiscount
- VkViapDiscount
- VkSppdDiscount
- DdDiscount
- DdViapDiscount
- DdSppdDiscount
- NkDiscount
- NkViapDiscount
- NkSppdDiscount
- N2Discount
- N2ViapDiscount
- N2SppdDiscount
- D1Discount

- D1ViapDiscount
- D1SppdDiscount
- D2Discount
- D2ViapDiscount
- D2SppdDiscount
- N1Discount
- N1ViapDiscount
- N1SppdDiscount
- VkPayingRecoveredEnergyDiscount
- VkPayingRecoveredMixedDiscount
- VkMissingEnergyDiscount
- VkMissingEnergyViapDiscount
- VkMissingEnergySppdDiscount
- FixedFeeAmountNoVAT
- VkAmountNoVAT
- VkViapAmountNoVAT
- VkSppdAmountNoVAT
- DdAmountNoVAT
- DdViapAmountNoVAT
- DdSppdAmountNoVAT
- NkAmountNoVAT
- NkViapAmountNoVAT
- NkSppdAmountNoVAT
- N2AmountNoVAT
- N2ViapAmountNoVAT
- N2SppdAmountNoVAT
- D1AmountNoVAT
- D1ViapAmountNoVAT
- D1SppdAmountNoVAT
- D2AmountNoVAT
- D2ViapAmountNoVAT
- D2SppdAmountNoVAT
- N1AmountNoVAT
- N1ViapAmountNoVAT
- N1SppdAmountNoVAT
- VkPayingRecoveredEnergyAmountNoVAT
- DdPayingRecoveredEnergyAmountNoVAT
- NkPayingRecoveredEnergyAmountNoVAT
- N2PayingRecoveredEnergyAmountNoVAT
- D1PayingRecoveredEnergyAmountNoVAT
- D2PayingRecoveredEnergyAmountNoVAT

- N1PayingRecoveredEnergyAmountNoVAT
- VkPayingRecoveredMixedAmountNoVAT
- DdPayingRecoveredMixedAmountNoVAT
- NkPayingRecoveredMixedAmountNoVAT
- N2PayingRecoveredMixedAmountNoVAT
- D1PayingRecoveredMixedAmountNoVAT
- D2PayingRecoveredMixedAmountNoVAT
- N1PayingRecoveredMixedAmountNoVAT
- VkMissingEnergyAmountNoVAT
- VkMissingEnergyViapAmountNoVAT
- VkMissingEnergySppdAmountNoVAT
- DdMissingEnergyAmountNoVAT
- DdMissingEnergyViapAmountNoVAT
- DdMissingEnergySppdAmountNoVAT
- NkMissingEnergyAmountNoVAT
- NkMissingEnergyViapAmountNoVAT
- NkMissingEnergySppdAmountNoVAT
- N2MissingEnergyAmountNoVAT
- N2MissingEnergyViapAmountNoVAT
- N2MissingEnergySppdAmountNoVAT
- D1MissingEnergyAmountNoVAT
- D1MissingEnergyViapAmountNoVAT
- D1MissingEnergySppdAmountNoVAT
- D2MissingEnergyAmountNoVAT
- D2MissingEnergyViapAmountNoVAT
- D2MissingEnergySppdAmountNoVAT
- N1MissingEnergyAmountNoVAT
- N1MissingEnergyViapAmountNoVAT
- N1MissingEnergySppdAmountNoVAT
- PowerPlantCapacityAmountNoVAT
- FixedFeeAmount
- VkAmount
- VkViapAmount
- VkSppdAmount
- DdAmount
- DdViapAmount
- DdSppdAmount
- NkAmount
- NkViapAmount
- NkSppdAmount
- N2Amount

- N2ViapAmount
- N2SppdAmount
- D1Amount
- D1ViapAmount
- D1SppdAmount
- D2Amount
- D2ViapAmount
- D2SppdAmount
- N1Amount
- N1ViapAmount
- N1SppdAmount
- VkPayingRecoveredEnergyAmount
- DdPayingRecoveredEnergyAmount
- NkPayingRecoveredEnergyAmount
- N2PayingRecoveredEnergyAmount
- D1PayingRecoveredEnergyAmount
- D2PayingRecoveredEnergyAmount
- N1PayingRecoveredEnergyAmount
- VkPayingRecoveredMixedAmount
- DdPayingRecoveredMixedAmount
- NkPayingRecoveredMixedAmount
- N2PayingRecoveredMixedAmount
- D1PayingRecoveredMixedAmount
- D2PayingRecoveredMixedAmount
- N1PayingRecoveredMixedAmount
- VkMissingEnergyAmount
- VkMissingEnergyViapAmount
- VkMissingEnergySppdAmount
- DdMissingEnergyAmount
- DdMissingEnergyViapAmount
- DdMissingEnergySppdAmount
- NkMissingEnergyAmount
- NkMissingEnergyViapAmount
- NkMissingEnergySppdAmount
- N2MissingEnergyAmount
- N2MissingEnergyViapAmount
- N2MissingEnergySppdAmount
- D1MissingEnergyAmount
- D1MissingEnergyViapAmount
- D1MissingEnergySppdAmount
- D2MissingEnergyAmount

- D2MissingEnergyViapAmount
- D2MissingEnergySppdAmount
- N1MissingEnergyAmount
- N1MissingEnergyViapAmount
- N1MissingEnergySppdAmount
- PowerPlantCapacityAmount
- FixedFeeIncludedVAT
- VkIncludedVAT
- VkViapIncludedVAT
- VkSppdIncludedVAT
- DdIncludedVAT
- DdViapIncludedVAT
- DdSppdIncludedVAT
- NkIncludedVAT
- NkViapIncludedVAT
- NkSppdIncludedVAT
- N2IncludedVAT
- N2ViapIncludedVAT
- N2SppdIncludedVAT
- D1IncludedVAT
- D1ViapIncludedVAT
- D1SppdIncludedVAT
- D2IncludedVAT
- D2ViapIncludedVAT
- D2SppdIncludedVAT
- N1IncludedVAT
- N1ViapIncludedVAT
- N1SppdIncludedVAT
- VkPayingRecoveredEnergyIncludedVAT
- DdPayingRecoveredEnergyIncludedVAT
- NkPayingRecoveredEnergyIncludedVAT
- N2PayingRecoveredEnergyIncludedVAT
- D1PayingRecoveredEnergyIncludedVAT
- D2PayingRecoveredEnergyIncludedVAT
- N1PayingRecoveredEnergyIncludedVAT
- VkPayingRecoveredMixedIncludedVAT
- DdPayingRecoveredMixedIncludedVAT
- NkPayingRecoveredMixedIncludedVAT
- N2PayingRecoveredMixedIncludedVAT
- D1PayingRecoveredMixedIncludedVAT
- D2PayingRecoveredMixedIncludedVAT

| | | |
|--------|------------|--|
| | | <ul style="list-style-type: none"> • N1PayingRecoveredMixedIncludedVAT • VkMissingEnergyIncludedVAT • VkMissingEnergyViapIncludedVAT • VkMissingEnergySppdIncludedVAT • DdMissingEnergyIncludedVAT • DdMissingEnergyViapIncludedVAT • DdMissingEnergySppdIncludedVAT • NkMissingEnergyIncludedVAT • NkMissingEnergyViapIncludedVAT • NkMissingEnergySppdIncludedVAT • N2MissingEnergyIncludedVAT • N2MissingEnergyViapIncludedVAT • N2MissingEnergySppdIncludedVAT • D1MissingEnergyIncludedVAT • D1MissingEnergyViapIncludedVAT • D1MissingEnergySppdIncludedVAT • D2MissingEnergyIncludedVAT • D2MissingEnergyViapIncludedVAT • D2MissingEnergySppdIncludedVAT • N1MissingEnergyIncludedVAT • N1MissingEnergyViapIncludedVAT • N1MissingEnergySppdIncludedVAT • PowerPlantCapacityIncludedVAT • PowerPlantCapacityUnit |
| 0.6.25 | 2021-04-21 | <p>Updated JSON specification of POST /reports/accounting-data-pack-b2b-meters-level method. Changed json fields ordering:</p> <ul style="list-style-type: none"> • CustomerID • ClientID • ClientName • ClientAddress • ObjectID • ObjectNumber • ObjectName • ObjectType • ObjectAddress • AgreementType • AgreementModel • AgreementFrom • AgreementTo |

- PermittablePowerConsumption
- PermittablePowerGeneration
- InstalledGeneratingPower
- InstalledConsumptionPower
- MetersAmount
- AutoMetersAmount
- ReportingPeriod
- BillingPeriod
- SupplyState
- SupplyStateFrom
- SupplyStateTo
- MetersNumber
- ReadingsSource
- ReadingsReceiveDate
- PaymentType
- DeclarationReferenceType
- Service
- ReferenceSubmitDate
- ReadingsSubmitDate
- DeclarationReferenceNumber
- UnaccountedConsumptionActNumber
- UnaccountedConsumptionActCreateDate
- UnaccountedConsumptionActFrom
- UnaccountedConsumptionActTo
- ConsumptionConversionActNumber
- ConsumptionConversionActCreateDate
- ConsumptionConversionActFrom
- ConsumptionConversionActTo
- ConsumptionState
- ConsumptionStateFrom
- ConsumptionStateTo
- TariffPlan
- PowerPlantCapacityDateFrom
- EnergyObtainedDateFrom
- PowerPlantCapacityDateTo
- PowerPlantCapacitySource
- PowerPlantCapacitySourceDateFrom
- PowerPlantCapacitySourceDateTo
- EnergyObtainedDateTo
- EnergyObtainedPowerKw
- TariffPlanChangeDate

- ConsumptionConversionAct
- UnaccountedAct
- ConversionAct
- OperatorGridElectricityPercent
- ClientGridElectricityPercent
- GaConsumptionAmount
- VkConsumptionAmount
- VkViapConsumptionAmount
- VkSppdConsumptionAmount
- VkDiscountConsumptionAmount
- DdConsumptionAmount
- DdViapConsumptionAmount
- DdSppdConsumptionAmount
- DdDiscountConsumptionAmount
- NkConsumptionAmount
- NkViapConsumptionAmount
- NkSppdConsumptionAmount
- NkDiscountConsumptionAmount
- MaConsumptionAmount
- MaViapConsumptionAmount
- VdConsumptionAmount
- VdViapConsumptionAmount
- SvConsumptionAmount
- SvViapConsumptionAmount
- MiConsumptionAmount
- MiViapConsumptionAmount
- RvConsumptionAmount
- RgConsumptionAmount
- VgConsumptionAmount
- Reliability1ConsumptionAmount
- Reliability2ConsumptionAmount
- Reliability3ConsumptionAmount
- TechnologicalCostsViapConsumptionAmount
- TechnologicalCostsConsumptionAmount
- GeneralInterestConsumptionAmount
- VkConsumedElectricityConsumptionAmount
- DdConsumedElectricityConsumptionAmount
- NkConsumedElectricityConsumptionAmount
- MaConsumedElectricityConsumptionAmount
- VdConsumedElectricityConsumptionAmount
- SvConsumedElectricityConsumptionAmount

- MiConsumedElectricityConsumptionAmount
- VkPayingRecoveredEnergyConsumptionAmount
- DdPayingRecoveredEnergyConsumptionAmount
- NkPayingRecoveredEnergyConsumptionAmount
- MaPayingRecoveredEnergyConsumptionAmount
- VdPayingRecoveredEnergyConsumptionAmount
- SvPayingRecoveredEnergyConsumptionAmount
- MiPayingRecoveredEnergyConsumptionAmount
- VkPayingRecoveredPercentConsumptionAmount
- DdPayingRecoveredPercentConsumptionAmount
- NkPayingRecoveredPercentConsumptionAmount
- MaPayingRecoveredPercentConsumptionAmount
- VdPayingRecoveredPercentConsumptionAmount
- SvPayingRecoveredPercentConsumptionAmount
- MiPayingRecoveredPercentConsumptionAmount
- VkPayingRecoveredPowerConsumptionAmount
- DdPayingRecoveredPowerConsumptionAmount
- NkPayingRecoveredPowerConsumptionAmount
- MaPayingRecoveredPowerConsumptionAmount
- VdPayingRecoveredPowerConsumptionAmount
- SvPayingRecoveredPowerConsumptionAmount
- MiPayingRecoveredPowerConsumptionAmount
- VkPayingRecoveredMixedConsumptionAmount
- DdPayingRecoveredMixedConsumptionAmount
- NkPayingRecoveredMixedConsumptionAmount
- MaPayingRecoveredMixedConsumptionAmount
- VdPayingRecoveredMixedConsumptionAmount
- SvPayingRecoveredMixedConsumptionAmount
- MiPayingRecoveredMixedConsumptionAmount
- VkMissingEnergyConsumptionAmount
- VkMissingEnergyViapConsumptionAmount
- VkMissingEnergySppdConsumptionAmount
- DdMissingEnergyConsumptionAmount
- DdMissingEnergyViapConsumptionAmount
- DdMissingEnergySppdConsumptionAmount
- NkMissingEnergyConsumptionAmount
- NkMissingEnergyViapConsumptionAmount
- NkMissingEnergySppdConsumptionAmount
- MaMissingEnergyConsumptionAmount
- MaMissingEnergyViapConsumptionAmount
- VdMissingEnergyConsumptionAmount

| | | |
|--|--|--|
| | | <ul style="list-style-type: none"> • VdMissingEnergyViapConsumptionAmount • SvMissingEnergyConsumptionAmount • SvMissingEnergyViapConsumptionAmount • MiMissingEnergyConsumptionAmount • MiMissingEnergyViapConsumptionAmount • VkMissingEnergyDiscountConsumptionAmount • DdMissingEnergyDiscountConsumptionAmount • NkMissingEnergyDiscountConsumptionAmount • GridSuppliedConsumptionAmount • AccumulatedBeginningConsumptionAmount • AccumulatedEndConsumptionAmount • AccumulatedTransferredConsumptionAmount • AccumulatedUploadedConsumptionAmount • AccumulatedRaisedConsumptionAmount • CompensatedConsumptionAmount • OldIndependentSupplier • PowerPlantCapacityConsumptionAmount • EnergyObtainedConsumptionAmount • OperatorGridElectricityConsumptionAmount • ClientGridElectricityConsumptionAmount • PowerPlantCapacityUnit • GaUnit • VkUnit • VkViapUnit • VkSppdUnit • VkDiscountUnit • DdUnit • DdViapUnit • DdSppdUnit • DdDiscountUnit • NkUnit • NkViapUnit • NkSppdUnit • NkDiscountUnit • MaUnit • MaViapUnit • VdUnit • VdViapUnit • SvUnit • SvViapUnit • MiUnit |
|--|--|--|

- MiViapUnit
- RvUnit
- RgUnit
- VgUnit
- Reliability1Unit
- Reliability2Unit
- Reliability3Unit
- TechnologicalCostsViapUnit
- TechnologicalCostsUnit
- GeneralInterestUnit
- VkConsumedElectricityUnit
- DdConsumedElectricityUnit
- NkConsumedElectricityUnit
- MaConsumedElectricityUnit
- VdConsumedElectricityUnit
- SvConsumedElectricityUnit
- MiConsumedElectricityUnit
- VkPayingRecoveredEnergyUnit
- DdPayingRecoveredEnergyUnit
- NkPayingRecoveredEnergyUnit
- MaPayingRecoveredEnergyUnit
- VdPayingRecoveredEnergyUnit
- SvPayingRecoveredEnergyUnit
- MiPayingRecoveredEnergyUnit
- VkPayingRecoveredPercentUnit
- DdPayingRecoveredPercentUnit
- NkPayingRecoveredPercentUnit
- MaPayingRecoveredPercentUnit
- VdPayingRecoveredPercentUnit
- SvPayingRecoveredPercentUnit
- MiPayingRecoveredPercentUnit
- VkPayingRecoveredPowerUnit
- DdPayingRecoveredPowerUnit
- NkPayingRecoveredPowerUnit
- MaPayingRecoveredPowerUnit
- VdPayingRecoveredPowerUnit
- SvPayingRecoveredPowerUnit
- MiPayingRecoveredPowerUnit
- VkPayingRecoveredMixedUnit
- DdPayingRecoveredMixedUnit
- NkPayingRecoveredMixedUnit

- MaPayingRecoveredMixedUnit
- VdPayingRecoveredMixedUnit
- SvPayingRecoveredMixedUnit
- MiPayingRecoveredMixedUnit
- VkMissingEnergyUnit
- VkMissingEnergyViapUnit
- VkMissingEnergySppdUnit
- DdMissingEnergyUnit
- DdMissingEnergyViapUnit
- DdMissingEnergySppdUnit
- NkMissingEnergyUnit
- NkMissingEnergyViapUnit
- NkMissingEnergySppdUnit
- MaMissingEnergyUnit
- MaMissingEnergyViapUnit
- VdMissingEnergyUnit
- VdMissingEnergyViapUnit
- SvMissingEnergyUnit
- SvMissingEnergyViapUnit
- MiMissingEnergyUnit
- MiMissingEnergyViapUnit
- VkMissingEnergyDiscountUnit
- DdMissingEnergyDiscountUnit
- NkMissingEnergyDiscountUnit
- VkReadingsFrom
- DdReadingsFrom
- NkReadingsFrom
- MaReadingsFrom
- VdReadingsFrom
- SvReadingsFrom
- MiReadingsFrom
- RvReadingsFrom
- RgReadingsFrom
- VkConsumedElectricityReadingsFrom
- DdConsumedElectricityReadingsFrom
- NkConsumedElectricityReadingsFrom
- MaConsumedElectricityReadingsFrom
- VdConsumedElectricityReadingsFrom
- SvConsumedElectricityReadingsFrom
- MiConsumedElectricityReadingsFrom
- GridSuppliedReadingsFrom

- VkReadingsTo
- DdReadingsTo
- NkReadingsTo
- MaReadingsTo
- VdReadingsTo
- SvReadingsTo
- MiReadingsTo
- RvReadingsTo
- RgReadingsTo
- VkConsumedElectricityReadingsTo
- DdConsumedElectricityReadingsTo
- NkConsumedElectricityReadingsTo
- MaConsumedElectricityReadingsTo
- VdConsumedElectricityReadingsTo
- SvConsumedElectricityReadingsTo
- MiConsumedElectricityReadingsTo
- GridSuppliedReadingsTo
- GaPriceEur
- VkPriceEur
- VkViapPriceEur
- VkSppdPriceEur
- VkDiscountPriceEur
- DdPriceEur
- DdViapPriceEur
- DdSppdPriceEur
- DdDiscountPriceEur
- NkPriceEur
- NkViapPriceEur
- NkSppdPriceEur
- NkDiscountPriceEur
- MaPriceEur
- MaViapPriceEur
- VdPriceEur
- VdViapPriceEur
- SvPriceEur
- SvViapPriceEur
- MiPriceEur
- MiViapPriceEur
- RvPriceEur
- RgPriceEur
- VgPriceEur

- Reliability1PriceEur
- Reliability2PriceEur
- Reliability3PriceEur
- TechnologicalCostsViapPriceEur
- TechnologicalCostsPriceEur
- GeneralInterestPriceEur
- VkPayingRecoveredEnergyPriceEur
- DdPayingRecoveredEnergyPriceEur
- NkPayingRecoveredEnergyPriceEur
- MaPayingRecoveredEnergyPriceEur
- VdPayingRecoveredEnergyPriceEur
- SvPayingRecoveredEnergyPriceEur
- MiPayingRecoveredEnergyPriceEur
- VkPayingRecoveredMixedPriceEur
- DdPayingRecoveredMixedPriceEur
- NkPayingRecoveredMixedPriceEur
- MaPayingRecoveredMixedPriceEur
- VdPayingRecoveredMixedPriceEur
- SvPayingRecoveredMixedPriceEur
- MiPayingRecoveredMixedPriceEur
- VkMissingEnergyPriceEur
- VkMissingEnergyViapPriceEur
- VkMissingEnergySppdPriceEur
- DdMissingEnergyPriceEur
- DdMissingEnergyViapPriceEur
- DdMissingEnergySppdPriceEur
- NkMissingEnergyPriceEur
- NkMissingEnergyViapPriceEur
- NkMissingEnergySppdPriceEur
- MaMissingEnergyPriceEur
- MaMissingEnergyViapPriceEur
- VdMissingEnergyPriceEur
- VdMissingEnergyViapPriceEur
- SvMissingEnergyPriceEur
- SvMissingEnergyViapPriceEur
- MiMissingEnergyPriceEur
- MiMissingEnergyViapPriceEur
- VkMissingEnergyDiscountPriceEur
- DdMissingEnergyDiscountPriceEur
- NkMissingEnergyDiscountPriceEur
- PowerPlantCapacityPriceEur

- GaDiscount
- VkDiscount
- VkViapDiscount
- VkSppdDiscount
- VkDiscountDiscount
- DdDiscount
- DdViapDiscount
- DdSppdDiscount
- DdDiscountDiscount
- NkDiscount
- NkViapDiscount
- NkSppdDiscount
- NkDiscountDiscount
- MaDiscount
- MaViapDiscount
- VdDiscount
- VdViapDiscount
- SvDiscount
- SvViapDiscount
- MiDiscount
- MiViapDiscount
- RvDiscount
- RgDiscount
- VgDiscount
- Reliability1Discount
- Reliability2Discount
- Reliability3Discount
- TechnologicalCostsViapDiscount
- TechnologicalCostsDiscount
- GeneralInterestDiscount
- VkPayingRecoveredEnergyDiscount
- VkPayingRecoveredMixedDiscount
- VkMissingEnergyDiscount
- VkMissingEnergyViapDiscount
- VkMissingEnergySppdDiscount
- VkMissingEnergyDiscountDiscount
- GaAmountNoVAT
- VkAmountNoVAT
- VkViapAmountNoVAT
- VkSppdAmountNoVAT
- VkDiscountAmountNoVAT

- DdAmountNoVAT
- DdViapAmountNoVAT
- DdSppdAmountNoVAT
- DdDiscountAmountNoVAT
- NkAmountNoVAT
- NkViapAmountNoVAT
- NkSppdAmountNoVAT
- NkDiscountAmountNoVAT
- MaAmountNoVAT
- MaViapAmountNoVAT
- VdAmountNoVAT
- VdViapAmountNoVAT
- SvAmountNoVAT
- SvViapAmountNoVAT
- MiAmountNoVAT
- MiViapAmountNoVAT
- RvAmountNoVAT
- RgAmountNoVAT
- VgAmountNoVAT
- Reliability1AmountNoVAT
- Reliability2AmountNoVAT
- Reliability3AmountNoVAT
- TechnologicalCostsViapAmountNoVAT
- TechnologicalCostsAmountNoVAT
- GeneralInterestAmountNoVAT
- VkPayingRecoveredEnergyAmountNoVAT
- DdPayingRecoveredEnergyAmountNoVAT
- NkPayingRecoveredEnergyAmountNoVAT
- MaPayingRecoveredEnergyAmountNoVAT
- VdPayingRecoveredEnergyAmountNoVAT
- SvPayingRecoveredEnergyAmountNoVAT
- MiPayingRecoveredEnergyAmountNoVAT
- VkPayingRecoveredMixedAmountNoVAT
- DdPayingRecoveredMixedAmountNoVAT
- NkPayingRecoveredMixedAmountNoVAT
- MaPayingRecoveredMixedAmountNoVAT
- VdPayingRecoveredMixedAmountNoVAT
- SvPayingRecoveredMixedAmountNoVAT
- MiPayingRecoveredMixedAmountNoVAT
- VkMissingEnergyAmountNoVAT
- VkMissingEnergyViapAmountNoVAT

| | | |
|--------|------------|---|
| | | <ul style="list-style-type: none"> • VkMissingEnergySppdAmountNoVAT • DdMissingEnergyAmountNoVAT • DdMissingEnergyViapAmountNoVAT • DdMissingEnergySppdAmountNoVAT • NkMissingEnergyAmountNoVAT • NkMissingEnergyViapAmountNoVAT • NkMissingEnergySppdAmountNoVAT • MaMissingEnergyAmountNoVAT • MaMissingEnergyViapAmountNoVAT • VdMissingEnergyAmountNoVAT • VdMissingEnergyViapAmountNoVAT • SvMissingEnergyAmountNoVAT • SvMissingEnergyViapAmountNoVAT • MiMissingEnergyAmountNoVAT • MiMissingEnergyViapAmountNoVAT • VkMissingEnergyDiscountAmountNoVAT • DdMissingEnergyDiscountAmountNoVAT • NkMissingEnergyDiscountAmountNoVAT • PowerPlantCapacityAmountNoVAT • PermanentHomePlusAmountNoVAT • PermanentHomeAmountNoVAT |
| 0.6.26 | 2021-04-30 | <p>Added error message text and 111 error code.</p> <ul style="list-style-type: none"> • POST /supplier/v2/supplier-change-notifications (new) <p>Added the rule 3 description and the new message (Code 10).</p> <ul style="list-style-type: none"> • POST /data/data-orders |
| 0.6.27 | 2021-05-07 | <p>(will be deployed in next sprint) Added new json fields "clientName", "contractType", "currentSupplierType" and json field "contractType" rename to "contractModel", change "contractModel" possible values in:</p> <ul style="list-style-type: none"> ▪ POST /supplier/client/client-objects-information (new) |
| 0.6.28 | 2021-05-13 | <p>Updated 9 error and 11 rule.</p> <ul style="list-style-type: none"> ▪ POST /gateway/supplier/send-declaration-data |

| | | |
|-------------------|-----------------------|---|
| 0.6.29 | 2021-06-03 | Updated 1 rule in: <ul style="list-style-type: none"> ▪ POST /supplier/cancel-supplier-change-notification |
| 0.6.30 | 2021-06-07 | Added contract data controller. |
| 0.6.31 | 2021-06-08 | Added new error message and rule description (4). <ul style="list-style-type: none"> • POST /data/data-orders |
| 0.6.32 | 2021-06-09 | Edited 108 error message. <ul style="list-style-type: none"> • POST /supplier/v2/supplier-change-notifications (new) |
| 0.6.33 | 2021-06-11 | The rule 55 was added. <ul style="list-style-type: none"> • POST /contract-data/{changeType}/contract-change-notification |
| 0.6.34 | 2021-06-16 | Updated JSON specification of POST /reports/accounting-data-pack-b2c method and /reports/accounting-data-pack-b2b-meters-level method. Added new fields: <ul style="list-style-type: none"> ▪ GeneratingCustomer |
| 0.6.35 | 2021-06-17 | Edited rule 2 description and error message 5; <ul style="list-style-type: none"> - POST /data/data-orders |
| 0.6.36 | 2021-06-22 | The new JSON field (contractType) and rule description were added; <ul style="list-style-type: none"> • POST /reports/objects-data-pack?first={integer}&count={integer} |
| 0.6.37 | 2021-06-22 | Updated method (from GET to POST): <ul style="list-style-type: none"> • POST /gateway/contract-data/{changeType}/objects-list?first={integer}&count={integer}&sort={ASC/DSC} • POST /contract-data/contract-change-notification-details?first={integer}&count={integer}&sort={ASC/DSC} |
| 0.6.38 | 2021-07-08 | Updated method URI name: <ul style="list-style-type: none"> ▪ POST /gateway/contract-data/{changeType}/objects-list?first={integer}&count={integer}&sortKey={string}&sortOrder={ASC/DSC} ▪ POST /gateway/contract-data/contract-change-notification-details?first={integer}&count={integer}&sortOrder={ASC/DSC} ▪ POST /gateway/contract-data/{changeType}/contract-change-notification ▪ POST /gateway/contract-data/cancel-contract-change-notification/{notificationId} |

| | | |
|--------|------------|--|
| | | <p>Updated method 'POST /gateway/contract-data/{changeType}/contract-change-notification' error and rules numbering.</p> <p>Inserted HTTP status code '204' in method:</p> <ul style="list-style-type: none"> • POST /gateway/contract-data/{changeType}/objects-list?first={integer}&count={integer}&sortKey={string}&sortOrder={ASC/DSC} • POST /gateway/contract-data/contract-change-notification-details?first={integer}&count={integer}&sortOrder={ASC/DSC} • POST /gateway/contract-data/cancel-contract-change-notification/{notificationId} |
| 0.6.39 | 2021-07-13 | <p>Updated json structure:</p> <ul style="list-style-type: none"> • POST /gateway/contract-data/contract-change-notification-details?first={integer}&count={integer}&sortOrder={ASC/DSC} • POST /gateway/contract-data/{changeType}/contract-change-notification |
| 0.6.40 | 2021-07-14 | Added contract termination notification controller. |
| 0.6.41 | 2021-07-16 | <p>Updated oldContractInfo segment json in:</p> <ul style="list-style-type: none"> • POST /gateway/contract-data/contract-change-notification-details?first={integer}&count={integer}&sortOrder={ASC/DSC} |
| 0.6.42 | 2021-08-03 | <p>Updated correspondenceAddress segment json in:</p> <ul style="list-style-type: none"> • POST /gateway/contract-data/contract-change-notification-details?first={integer}&count={integer}&sortOrder={ASC/DSC} |
| 0.6.43 | 2021-08-04 | Added an additional status „I - Sent“ of contract data controller. |
| 0.6.44 | 2021-08-05 | <p>Added the new methods for the reports' orders.</p> <ul style="list-style-type: none"> • Metodas reports-orders-list <ul style="list-style-type: none"> ○ POST/gateway/report-order-data/{supplierCode}/reports-orders-list?first={integer}&count={integer}&sortKey={string}&sortOrder={ASC/DSC} • Metodas report-order-details <ul style="list-style-type: none"> ○ GET/gateway/report-order-data/{supplierCode}/report-order-details/{orderId} • Metodas order-hourly-report-data <ul style="list-style-type: none"> ○ POST/gateway/report-order-data/{supplierCode}/{reportShortName}/order-hourly-report-data • Metodas order-report-data <ul style="list-style-type: none"> ○ POST/gateway/report-order-data/{supplierCode}/{reportShortName}/order-report-data • Metodas ordered-report-hr <ul style="list-style-type: none"> ○ GET/gateway/report-order-data/{supplierCode}/ordered-report-hr/{orderId} <p>Added the new methods for the reports' orders. Metodas ordered-report-obj</p> |

| | | |
|--------|------------|---|
| | | <ul style="list-style-type: none"> •GET/gateway/report-order-data/{supplierCode}/ordered-report-obj/{orderId} <p>Added the new methods for the reports' orders.</p> <ul style="list-style-type: none"> • GET/gateway/report-order-data/{supplierCode}/ordered-report-b2c/{orderId} Metodas ordered-report-b2b • GET/gateway/report-order-data/{supplierCode}/ordered-report-b2b/{orderId} Metodas ordered-report-b2bm • GET/gateway/report-order-data/{supplierCode}/ordered-report-b2bm/{orderId} |
| 0.6.45 | 2021-08-09 | <p>Changed 12 and 17 error messages in method:</p> <ul style="list-style-type: none"> • POST /gateway/contract-data/{changeType}/contract-change-notification |
| 0.6.46 | 2021-08-10 | <p>ContractModel moved to object level in method:</p> <ul style="list-style-type: none"> • POST /gateway/contract-data/{changeType}/contract-change-notification |
| 0.6.47 | 2021-08-11 | <p>Changed 14 error message and added 36 error message in method:</p> <ul style="list-style-type: none"> • POST /gateway/contract-data/{changeType}/contract-change-notification |
| 0.6.48 | 2021-08-12 | <p>Added 37, 38, 39, 40 error messages and 50, 51, 52, 53 rules in method:</p> <ul style="list-style-type: none"> • POST /gateway/contract-data/{changeType}/contract-change-notification |
| 0.6.49 | 2021-08-24 | <p>Added 41, 42 error messages and modified 53, 6, 54, 56 rules in method:</p> <ul style="list-style-type: none"> • POST /gateway/contract-data/{changeType}/contract-change-notification <p>Changed 33 error message code into 1003 in method:</p> <ul style="list-style-type: none"> • POST /gateway/contract-data/{changeType}/contract-change-notification <p>Added json field ,payoffMethod' in method:</p> <ul style="list-style-type: none"> • POST /gateway/contract-data/{changeType}/objects-list?first={integer}&count={integer}&sortKey={string}&sortOrder={ASC/DSC} <p>Added json field ,payoffMethod' in ,oldContractInfo.object' group, in method:</p> <ul style="list-style-type: none"> • POST /gateway/contract-data/contract-change-notification-details?first={integer}&count={integer}&sortOrder={ASC/DSC} <p>Added 14 error message and rule description</p> <ul style="list-style-type: none"> • POST /gateway/supplier/send-declaration-data <p>Changed 1, 2 error codes into 1001 and 1002 in:</p> <ul style="list-style-type: none"> • contract data controller • contract data controler - termination data <p>Removed 4 error from:</p> <ul style="list-style-type: none"> • POST /gateway/contract-data/{changeType}/objects-list?first={integer}&count={integer}&sortKey={string}&sortOrder={ASC/DSC} |
| 0.6.50 | 2021-08-30 | <p>Removed the field ,ownershipDocumentDate' in method:</p> <ul style="list-style-type: none"> • POST /gateway/contract-data/contract-change-notification-details?first={integer}&count={integer}&sortOrder={ASC/DSC} |
| 0.6.51 | 2021-08-31 | <p>Modified 23 rule and 41 error message in method:</p> <ul style="list-style-type: none"> • POST /gateway/contract-data/{changeType}/contract-change-notification <p>Added 54 rule and 43 error message in method:</p> |

| | | |
|--------|------------|--|
| | | <ul style="list-style-type: none"> • POST /gateway/contract-data/{changeType}/contract-change-notification |
| 0.6.52 | 2021-09-03 | Added 58, 59, 60 rules and 44, 45, 46 error messages in method: <ul style="list-style-type: none"> • POST /gateway/contract-data/{changeType}/contract-change-notification |
| 0.6.53 | 2021-09-10 | Added the GET method of the 2SS report: <ul style="list-style-type: none"> • GET/gateway/report-order-data/ordered-report-data-2ss/{orderId} |
| 0.6.54 | 2021-09-23 | Added the description of the 9 error message: <ul style="list-style-type: none"> • POST /gateway/supplier/send-declaration-data |
| 0.6.55 | 2021-09-27 | Added json field objectDataConsentSign and 3, 4, 5 rules in method: <ul style="list-style-type: none"> • POST /gateway/contract-data/{changeType}/objects-list?first={integer}&count={integer}&sortKey={string}&sortOrder={ASC/DSC} Modified 28, 31 rules and added 61, 62 rules and 48, 49 errors in method: <ul style="list-style-type: none"> • POST /gateway/contract-data/{changeType}/contract-change-notification |
| 0.6.56 | 2021-09-28 | Added rule description 5: <ul style="list-style-type: none"> • GET/gateway/report-order-data/ordered-report-data-hr/{orderId} |
| 0.6.57 | 2021-10-04 | Value of json field „status“ was modified from „PR – Approved“ into „IV – Completed“ in controller: <ul style="list-style-type: none"> • Contract data controller • Contract data controller – termination data |
| 0.6.58 | 2021-10-06 | Added 19 rule and 120 error in method: <ul style="list-style-type: none"> • POST /gateway/contract-data/termination-data/contract-termination-notification |
| 0.6.59 | 2021-10-12 | Removed 5 rule in method: <ul style="list-style-type: none"> • POST /gateway/contract-data/{changeType}/objects-list?first={integer}&count={integer}&sortKey={string}&sortOrder={ASC/DSC} |
| 0.6.60 | 2021-10-13 | Removed “JSON request”: dateFrom, dateTo. Added “JSON request”: contractSartFrom, contractStartTo, submittedDateFrom, submittedDateTo, in method: <ul style="list-style-type: none"> • POST /gateway/contract-data/contract-change-notification-details?first={integer}&count={integer}&sortOrder={ASC/DSC} Removed “JSON request”: dateFrom, dateTo. Added “JSON request”: contractTerminationDateFrom, contractTerminationDateTo, submittedDateFrom, submittedDateTo, in method: <ul style="list-style-type: none"> • POST /gateway/contract-data/termination-data/contract-termination-notification-details?first={integer}&count={integer}&sortOrder={ASC/DSC} |
| 0.6.61 | 2021-10-15 | Added the new supplier change notification v2 controller: -POST method: <ul style="list-style-type: none"> • POST /gateway/supplier-change-notification/v2/objects-list?first={integer}&count={integer}&sortKey={string}&sortOrder={ASC/DSC} |
| 0.6.62 | 2021-10-19 | Added the POST methods of supplier change notification v2 controller: <ul style="list-style-type: none"> • POST /gateway/supplier-change-notification/v2/list?first={integer}&count={integer}&sortKey={string}&sortOrder={ASC/DSC} • POST /gateway/supplier-change-notification/v2 • POST /gateway/supplier-change-notification/v2/{notificationId}/cancel |

| | | |
|--------|------------|--|
| 0.6.63 | 2021-10-17 | <p>Added new fields noCoowner, ntGetCoownerConsent, coownerConsentDate in method:</p> <ul style="list-style-type: none"> • POST /gateway/contract-data/termination-data/contract-termination-notification-details?first={integer}&count={integer}&sortOrder={ASC/DSC} |
| 0.6.64 | 2021-10-28 | <p>Added submittedDateFrom/To attribute to the JSON request:</p> <ul style="list-style-type: none"> • POST/gateway/report-order-data/reports-orders-list?first={integer}&count={integer}&sortKey={string}&sortOrder={ASC/DSC} <p>Removed the error message (error code 9) from the new methods of the reports. Changed searchParameter to orderParameter. Changed auto_order to auto.</p> <p>Edited the attributes of the JSON request:</p> <ul style="list-style-type: none"> • POST/gateway/report-order-data/{reportShortName}/order-report-data. |
| 0.6.65 | 2021-10-29 | <p>Removed “JSON request”: objectNumbers. Added “JSON request”: objects, objectNumber, noCoowner, ntGetCoownerConsent, coownerConsentDate AND added new error messages (no. 20 – 26) in method:</p> <ul style="list-style-type: none"> • POST /gateway/contract-data/termination-data/contract-termination-notification |
| 0.6.66 | 2021-11-03 | <p>Edited the structure of the JSON:</p> <ul style="list-style-type: none"> • GET/gateway/report-order-data/ordered-report-data-2ss/{orderId} |
| 0.6.67 | 2021-11-05 | <p>Added JSON attribute „userName“:</p> <ul style="list-style-type: none"> • POST /gateway/supplier-change-data/supplier-change-notification-list?first={integer}&count={integer}&sortKey={string}&sortOrder={ASC/DSC} • POST /gateway/contract-data/termination-data/contract-termination-notification-details?first={integer}&count={integer}&sortOrder={ASC/DSC} • POST /gateway/contract-data/contract-change-notification-details?first={integer}&count={integer}&sortOrder={ASC/DSC} <p>Added JSON parameters „userNameSearch“:</p> <ul style="list-style-type: none"> • POST /gateway/supplier-change-data/supplier-change-notification-list?first={integer}&count={integer}&sortKey={string}&sortOrder={ASC/DSC} • POST /gateway/contract-data/termination-data/contract-termination-notification-details?first={integer}&count={integer}&sortOrder={ASC/DSC} • POST /gateway/contract-data/contract-change-notification-details?first={integer}&count={integer}&sortOrder={ASC/DSC} |
| 0.6.68 | 2021-11-08 | <p>Added 63 rule and 51 error in method:</p> <ul style="list-style-type: none"> • POST /gateway/contract-data/{changeType}/contract-change-notification |

| | | |
|--------|------------|---|
| 0.6.69 | 2021-11-11 | <p>Changed URL (Contract termination notification controller):</p> <ul style="list-style-type: none"> • POST /gateway/contract-termination-notification/object-list?first={integer}&count={integer}&sortKey={string}&sortOrder={ASC/DSC} • POST /gateway/contract-termination-notification/details?first={integer}&count={integer}&sortOrder={ASC/DSC} • POST /gateway/contract-termination-notification • POST /gateway/contract-termination-notification/{notificationId}/cancel |
| 0.6.70 | 2021-11-11 | Name of Contract data controller was changed into Contract change notification controller. |
| 0.6.71 | 2021-11-11 | <p>Changed URL (Supplier change notification controller):</p> <ul style="list-style-type: none"> • POST /gateway/supplier-change-notification/v2/object-list?first={integer}&count={integer}&sortKey={string}&sortOrder={ASC/DSC} • POST /gateway/supplier-change-notification/v2/list?first={integer}&count={integer}&sortKey={string}&sortOrder={ASC/DSC} • POST /gateway/supplier-change-notification/v2 • POST /gateway/supplier-change-notification/v2/{notificationId}/cancel |
| 0.6.72 | 2021-11-12 | <p>Changed URL (Order controller):</p> <ul style="list-style-type: none"> • POST/gateway/order/list?first={integer}&count={integer}&sortKey={string}&sortOrder={ASC/DSC} • GET/gateway/order/{orderId}/details • POST/gateway/order/{orderShortName}/hourly • POST/gateway/order/{orderShortName} • GET/gateway/order/{orderId}/hr • GET/gateway/order/{orderId}/2ss |
| | | <p>Changed URL (Order controller):</p> <ul style="list-style-type: none"> • GET/gateway/order/{orderId}/obj |
| | | <p>Changed URL (Order controller):</p> <ul style="list-style-type: none"> • GET/gateway/order/{orderId}/b2c • GET/gateway/order/{orderId}/b2b |
| 0.6.73 | 2021-11-15 | <p>Error message was deleted:</p> <ul style="list-style-type: none"> • POST/gateway/order/{orderShortName} |
| | | <p>Changed the JSON structure, added new attribute:</p> <ul style="list-style-type: none"> • GET/gateway/order/{orderId}/obj |

| | | |
|--------|------------|---|
| 0.6.74 | 2021-11-15 | <p>Added the new error message 1004:</p> <ul style="list-style-type: none"> • POST /reports/accounting-data-pack-b2c?first={integer}&count={integer} • POST /reports/accounting-data-pack-b2b?first={integer}&count={integer} • POST /reports/accounting-data-pack-b2b-meters-level?first={integer}&count={integer} • POST /reports/objects-data-pack?first={integer}&count={integer} |
| 0.6.75 | 2021-11-15 | <p>Changed 46, 15, 16 rules and deleted 36 error in method:</p> <ul style="list-style-type: none"> • POST /gateway/contract-data/{changeType}/contract-change-notification |
| 0.6.76 | 2021-11-17 | <p>JSON attributes were changed:</p> <ul style="list-style-type: none"> • POST/gateway/order/{orderShortName} |
| | | <p>JSON attributes were changed:</p> <ul style="list-style-type: none"> • GET/gateway/order/{orderId}/obj |
| 0.6.77 | 2021-11-18 | <p>(Order controller) B2B order was deleted. B2Bm was renamed to B2B. Added the new error message and deleted the attribute "statusDate"</p> <ul style="list-style-type: none"> • POST/gateway/order/list?first={integer}&count={integer}&sortKey={string}&sortOrder={ASC/DSC} • Order controller codes of the error messages were changed. |
| 0.6.78 | 2021-11-19 | <p>Changed 17 error message in method:</p> <ul style="list-style-type: none"> • POST /gateway/contract-data/{changeType}/contract-change-notification |
| 0.6.79 | 2021-11-24 | <p>JSON request attributes were deleted:</p> <ul style="list-style-type: none"> • POST/gateway/order/{orderShortName} <p>Added the new error message:</p> <ul style="list-style-type: none"> • POST/gateway/order/{orderShortName}/hourly |
| 0.6.80 | 2021-12-03 | <p>Changed data type of the attributes (submittedDateFrom, submittedDateTo, dateFrom, dateTo)</p> <ul style="list-style-type: none"> • POST/gateway/order/list?first={integer}&count={integer}&sortKey={string}&sortOrder={ASC/DSC} • POST/gateway/order/{orderShortName} <p>Deleted error message 2003:</p> <ul style="list-style-type: none"> • POST/gateway/order/list?first={integer}&count={integer}&sortKey={string}&sortOrder={ASC/DSC} <p>Edited error message 2003:</p> <ul style="list-style-type: none"> • POST/gateway/order/{orderShortName} • POST/gateway/order/{orderShortName}/hr |

| | | |
|--------|------------|--|
| 0.6.81 | 2021-12-06 | Deleted 2006 error message, changed 2001 error message <ul style="list-style-type: none"> • POST/gateway/order/{orderShortName} |
| 0.6.82 | | Added the new error message 2015 <ul style="list-style-type: none"> • POST/gateway/order/{orderShortName} • POST/gateway/order/{orderShortName}/hr |
| 0.6.83 | 2021-12-09 | Changed JSON request structure, deleted 2001 error message and edited 2007 error message: <ul style="list-style-type: none"> • POST/gateway/order/{orderShortName}/hr |
| 0.6.84 | 2021-12-10 | Added the error messages and rule description 112,113: <ul style="list-style-type: none"> • POST /gateway/supplier-change-notification/v2 • POST /supplier/v2/supplier-change-notifications |
| 0.6.85 | 2021-12-13 | Added new controller: "Contract object". <ul style="list-style-type: none"> • Added new method: POST /gateway/contract-object/list?first={integer}&count={integer}&sortKey={string}&sortOrder={ASC/DSC} The method is designed to obtain a list of valid objects in the contract according to the selection criteria. • Removed method: POST /gateway/contract-termination-notification/object-list?first={integer}&count={integer}&sortKey={string}&sortOrder={ASC/DSC} |
| 0.6.86 | 2021-12-14 | Added the new controller and methods: <ul style="list-style-type: none"> • The new controller – Tariff plan change notification controller • POST /gateway/tariff-plan-change-notification/list??first={integer}&count={integer}&sortKey={string}&sortOrder={ASC/DSC} • POST /gateway/tariff-plan-change-notification • POST /gateway/tariff-plan-change-notification/{notificationId}/cancel |
| 0.6.87 | 2021-12-16 | Removed 25 and 26 error in method: <ul style="list-style-type: none"> • POST /gateway/contract-data/{changeType}/contract-change-notification |
| 0.6.88 | 2021-12-21 | Added the contract list controller: <ul style="list-style-type: none"> • POST/gateway/contract/list?first={integer}&count={integer}&sortKey={string}&sortOrder={ASC/DSC} |
| 0.6.89 | 2021-12-22 | Added the new controller – Contact change notification controller: <ul style="list-style-type: none"> • POST /gateway/contact-change-notification/list??first={integer}&count={integer}&sortKey={string}&sortOrder={ASC/DSC} • POST /gateway/contact-change-notification • POST /gateway/contact-change-notification/{notificationId}/cancel |
| 0.6.90 | 2021-12-22 | Edited the 112 and 103 error messages. Added the new error 116 <ul style="list-style-type: none"> • POST /supplier/v2/supplier-change-notifications (new) |

| | | |
|--------|------------|---|
| 0.6.91 | 2021-12-23 | Added new json field `mobPhoneNoObject` in method: <ul style="list-style-type: none"> POST /gateway/object/my/active/list?first={integer}&count={integer}&sortKey={string}&sortOrder={ASC/DSC} |
| 0.6.92 | 2021-12-23 | Edited JSON structure: <ul style="list-style-type: none"> GET/gateway/order/{orderId}/2ss |
| | | Changed attribute name: <ul style="list-style-type: none"> GET/gateway/order/{orderId}/obj |
| 0.6.93 | 2021-12-30 | Added new 117 error in method: <ul style="list-style-type: none"> POST /supplier/v2/supplier-change-notifications (new) |
| 0.6.94 | 2022-01-04 | Changed GET url: <ul style="list-style-type: none"> GET/gateway/order/{orderId}/2s2s Changed orderShortName and orderName from 2ss to 2s2s: <ul style="list-style-type: none"> POST/gateway/order/list?first={integer}&count={integer}&sortKey={string}&sortOrder={ASC/DSC} POST/gateway/order/{orderShortName} Changed username attribute to usreName: <ul style="list-style-type: none"> POST/gateway/order/list?first={integer}&count={integer}&sortKey={string}&sortOrder={ASC/DSC} |
| 0.6.95 | 2022-01-06 | Deleted POST and GET methods: <ul style="list-style-type: none"> POST/gateway/order/{orderShortName}/hr GET/gateway/order/{orderId}/hr Added new methods: <ul style="list-style-type: none"> POST/gateway/order/hr-object POST/gateway/order/hr-meter GET/gateway/order/{orderId}/hr-object GET/gateway/order/{orderId}/hr-meter GET/gateway/order/{orderId}/hr-object/count GET/gateway/order/{orderId}/hr-meter/count |
| 0.6.96 | 2022-01-11 | Changed the structure of the JSON Response <ul style="list-style-type: none"> GET/gateway/order/{orderId}/2s2s |
| 0.9.97 | 2022-01-13 | Added new 127 error and 26 rule in method: <ul style="list-style-type: none"> POST /gateway/contract-termination-notification |
| 0.9.98 | 2022-01-13 | Removed "ntGetCoownerConsent", renamed "noCoowner" into "coowner" in methods: <ul style="list-style-type: none"> POST /gateway/contract-termination-notification/details?first={integer}&count={integer}&sortOrder={ASC/DSC} POST /gateway/contract-termination-notification |

| | | |
|--------|------------|---|
| | | <p>Edited 121, 122 error, removed 124, 125 error, added 128 error in method:</p> <ul style="list-style-type: none"> • POST /gateway/contract-termination-notification |
| 0.9.99 | 2022-01-14 | <p>Deleted the methods:</p> <ul style="list-style-type: none"> • POST/gateway/order/hr-object • POST/gateway/order/hr-meter • GET/gateway/order/{orderId}/hr-object/count • GET/gateway/order/{orderId}/hr-meter/count <p>Added the method:</p> <ul style="list-style-type: none"> • POST/gateway/order/{orderShortName} • GET/gateway/order/{orderId}/{orderShortName}/count <p>Added the error message 2016 and 2017 for the GET methods.</p> |
| 0.7.0 | 2022-01-17 | <p>JSON attribute changed from consumerCode to personCode</p> <ul style="list-style-type: none"> • GET/gateway/order/{orderId}/hr-object • GET/gateway/order/{orderId}/hr-meter <p>Added new attribute objectBsld to JSON respons structure:</p> <ul style="list-style-type: none"> • GET/gateway/order/{orderId}/hr-object • GET/gateway/order/{orderId}/hr-meter <p>Added new attribute objectBsld to JSON respons structure:</p> <ul style="list-style-type: none"> • GET/gateway/order/{orderId}/2s2s <p>Added new attribute objectBsld to JSON respons structure:</p> <ul style="list-style-type: none"> • GET/gateway/order/{orderId}/obj |
| 0.7.1 | 2022-01-24 | <ul style="list-style-type: none"> • “Contract object controller” renamed into “Object controller” • Url “POST /gateway/contract-object/list?first={integer}&count={integer}&sortKey={string}&sortOrder={ASC/DSC}” renamed into “POST /gateway/object/my/active/list?first={integer}&count={integer}&sortKey={string}&sortOrder={ASC/DSC}” • Added new field “supplyOwnership” in method: “POST /gateway/object/my/active/list?first={integer}&count={integer}&sortKey={string}&sortOrder={ASC/DSC}” • A new method “POST /gateway/object/all/active/list?first={integer}&count={integer}&sortKey={string}&sortOrder={ASC/DSC}” has been created for the method “POST /gateway/contract-data/{changeType}/objects-list?first={integer}&count={integer}&sortKey={string}&sortOrder={ASC/DSC}”. Changes are highlighted in green in method: “POST /gateway/object/all/active/list?first={integer}&count={integer}&sortKey={string}&sortOrder={ASC/DSC}” |

| | | |
|-------|------------|---|
| | | <ul style="list-style-type: none"> • A method: “POST /gateway/contract-data/{changeType}/objects-list?first={integer}&count={integer}&sortKey={string}&sortOrder={ASC/DSC}” will be eliminated. • Removed 40 error in method: POST /gateway/contract-data/{changeType}/contract-change-notification |
| 0.7.2 | 2022-01-24 | <p>Added the new method in the Order controller:</p> <ul style="list-style-type: none"> • GET/gateway/order/list/count <p>Changed parameter name from orderShortName to hrOrderShortName:</p> <ul style="list-style-type: none"> • POST/gateway/order/{hrOrderShortName} |
| 0.7.3 | 2022-01-24 | <p>“Tariff plan change notification controller” renamed into “Notification contract tariff plan controller”. Changed URL in the “Notification contract tariff plan controller”:</p> <ul style="list-style-type: none"> • POST /gateway/notification/contract/tariff-plan/list?first={integer}&count={integer}&sortKey={string}&sortOrder={ASC/DSC} • POST /gateway/notification/contract/tariff-plan • POST /gateway/notification/{notificationId}/contract/tariff-plan/cancel <p>“Contact change notification controller” renamed into “Notification contract contact controller”. Changed URL in the “Notification contract contact controller”:</p> <ul style="list-style-type: none"> • POST /gateway/notification/contract/contact/list?first={integer}&count={integer}&sortKey={string}&sortOrder={ASC/DSC} • POST /gateway/notification/contract/contact • POST /gateway/notification/{notificationId}/contract/contact/cancel |
| 0.7.4 | 2022-01-24 | <p>“Contract termination notification controller” renamed into “Notification contract termination controller”. Changed URL in the “Notification contract termination controller”:</p> <ul style="list-style-type: none"> • POST /gateway/notification/contract/termination/list?first={integer}&count={integer}&sortOrder={ASC/DSC} • POST /gateway/notification/contract/termination • POST /gateway/notification/{notificationId}/contract/termination/cancel |
| 0.7.5 | 2022-01-24 | <p>Added new controller “Notification contract controller”.</p> <ul style="list-style-type: none"> • Methods in this controller are very similar to method in controller „Contract change notification controller“. Differences are highlighted in green. • Note: The controller “Contract change notification controller” and its methods will be eliminated after “Notification contract controller” implementation date + 6 months. |
| 0.7.6 | 2022-01-27 | <p>Changed 10, 11, 17 rules and 11 error in method:</p> <ul style="list-style-type: none"> • POST /gateway/contract-data/{changeType}/contract-change-notification |

| | | |
|--------|------------|--|
| | | Note: In the new method “POST /gateway/notification/contract/owner”, these rules and error will also be implemented. |
| 0.7.7 | 2022-01-27 | Added new attribute (statusDate) in the method: POST/gateway/order/list?first={integer}&count={integer}&sortKey={string}&sortOrder={ASC/DSC} |
| 0.7.8 | 2022-01-28 | Removed controller and its methods “Supplier change notification v2 controller”. It has not yet been implemented, only a change in the documentation. |
| 0.7.9 | 2022-01-31 | Added errorType in method: POST /gateway/notification/contract/list?first={integer}&count={integer}&sortOrder={ASC/DSC} |
| 0.7.10 | 2022-01-31 | Added errorType in method: POST /gateway/notification/contract/termination/list?first={integer}&count={integer}&sortOrder={ASC/DSC} |
| 0.7.11 | 2022-02-01 | Edited 71 error and 10 rule in method: POST /gateway/notification/contract/termination |
| 0.7.12 | 2022-02-03 | Added the new rule 2018: <ul style="list-style-type: none"> • GET/gateway/order/{orderId}/hr-object • GET/gateway/order/{orderId}/hr-meter • GET/gateway/order/{orderId}/2s2s |
| | | Added the new rule 2018: <ul style="list-style-type: none"> • GET/gateway/order/{orderId}/obj |
| | | Added the new rule 2018: <ul style="list-style-type: none"> • GET/gateway/order/{orderId}/b2c • GET/gateway/order/{orderId}/b2b |
| 0.7.13 | 2022-02-04 | Deleted the error message 2007: <ul style="list-style-type: none"> • POST/gateway/order/{hrOrderShortName}; • POST/gateway/order/{orderShortName} |
| 0.7.14 | 2022-02-07 | Deleted satusDate attribute: <ul style="list-style-type: none"> • POST/gateway/order/list |
| 0.7.15 | 2022-02-11 | Edited 24 error in method: <ul style="list-style-type: none"> • POST /gateway/contract-data/{changeType}/contract-change-notification |
| 0.7.16 | 2022-02-17 | Added the attribute statusDate in JSON response structure of the method: <ul style="list-style-type: none"> • POST/gateway/order/list |

| | | |
|--------|------------|---|
| 0.7.17 | 2022-02-21 | Changed data type from timestamp to date and attributes names were changed: <ul style="list-style-type: none"> • GET/gateway/order/{orderId}/obj |
| | | consumptionCategory changed from not required to required: <ul style="list-style-type: none"> • POST/gateway/order/{hrOrderShortName} |
| 0.7.18 | 2022-02-22 | Added "meterNumbers":[string] in method: <ul style="list-style-type: none"> • POST /gateway/notification/contract/list?first={integer}&count={integer}&sortOrder={ASC/DSC} |
| 0.7.19 | 2022-02-22 | Added method: <ul style="list-style-type: none"> • POST/v2/data/data-orders This method already exists, was lost in the documentation |
| 0.7.20 | 2022-02-23 | Added new error message 1004: <ul style="list-style-type: none"> • POST/gateway/order/{hrOrderShortName} • POST/gateway/order/{orderShortName} |
| | | Changed JSON attributes names: personName; personSurnaem; objectId: <ul style="list-style-type: none"> • GET/gateway/order/{orderId}/2s2s • GET/gateway/order/{orderId}/hr-object • GET/gateway/order/{orderId}/hr-meter |
| | | Changed JSON attributes names: personName; personSurnaem; objectId: <ul style="list-style-type: none"> • GET/gateway/order/{orderId}/obj |
| 0.7.21 | 2022-02-28 | Added the new rule 2019 in Order controller: <ul style="list-style-type: none"> • POST/gateway/order/{orderShortName} |
| 0.7.22 | 2022-03-02 | Changed JSON response structure, generatingObjectType moved to product level: <ul style="list-style-type: none"> • GET/gateway/order/{orderId}/2s2s |
| 0.7.23 | 2022-03-03 | Removed 39 error in method: <ul style="list-style-type: none"> • POST /gateway/notification/contract/owner • POST /gateway/contract-data/{changeType}/contract-change-notification |
| 0.7.24 | 2022-03-07 | Added json field PayoffMethod in method: <ul style="list-style-type: none"> • POST /reports/objects-data-pack?first={integer}&count={integer} |
| 0.7.25 | 2022-03-08 | Added method: <ul style="list-style-type: none"> • POST /gateway/declaration/reading/list |
| 0.7.26 | 2022-03-21 | Deleted rule description. <ul style="list-style-type: none"> • POST/gateway/order/{hrOrderShortName} |
| 0.7.27 | 2022-03-22 | Added objectPowers in method: <ul style="list-style-type: none"> • POST /gateway/object/all/active/list?first={integer}&count={integer}&sortKey={string}&sortOrder={ASC/DSC} |

| | | |
|--------|------------|--|
| 0.7.28 | 2022-03-25 | Changed the JSON response attribute name from the status to latestStatus: <ul style="list-style-type: none"> • POST/gateway/order/list |
| 0.7.29 | 2022-03-28 | Changed attribute name from orderShortName to orderType: <ul style="list-style-type: none"> • POST/gateway/order/list • POST/gateway/order/list/count |
| 0.7.30 | 2022-03-28 | Removed json tariffPlanCategory in method: <ul style="list-style-type: none"> • POST /gateway/object/my/active/list?first={integer}&count={integer}&sortKey={string}&sortOrder={ASC/DSC} |
| 0.7.31 | 2022-03-31 | Edited json request attribute from objectNumber to objectNumbers <ul style="list-style-type: none"> • POST/order/{hrOrderShortName} |
| 0.7.32 | 2022-03-31 | Edited json request attribute from orderType to orderTypes <ul style="list-style-type: none"> • POST/gateway/order/list |
| 0.7.33 | 2022-04-01 | Edited json request attribute "status", added json request attribute "changeType" in method: <ul style="list-style-type: none"> • POST /gateway/notification/contract/list?first={integer}&count={integer}&sortOrder={ASC/DSC} |
| 0.7.34 | 2022-04-04 | Changed HTTP status from 200 to 201 in method: <ul style="list-style-type: none"> • POST/gateway/order/{orderShortName} • POST/gateway/order/{hrOrderShortName} |
| 0.7.35 | 2022-04-05 | Added "6.1.3.4 Algorithm for using DELTA solution". Method: <ul style="list-style-type: none"> • POST /gateway/declaration/reading/list |
| 0.7.36 | 2022-04-07 | Changed possible meanings "orderType". Method: <ul style="list-style-type: none"> • POST/gateway/order/list?first={integer}&count={integer}&sortKey={string}&sortOrder={ASC/DSC} Changed a parameter "hr15OrderShortName" and url. Method: <ul style="list-style-type: none"> • POST/gateway/order/{hr15OrderShortName} Changed a parameter "orderShortName". Method: <ul style="list-style-type: none"> • POST/gateway/order/{orderShortName} Changed url from "GET/gateway/order/{orderId}/hr-object" to "GET/gateway/order/{orderId}/data-hr-15min-obj-lvl". Changed url from "GET/gateway/order/{orderId}/hr-meter" to "GET/gateway/order/{orderId}/data-hr-15min-mtr-lvl". Changed url from "GET/gateway/order/{orderId}/2s2s" to "GET/gateway/order/{orderId}/bill-2s2s-b2b". Changed url from "GET/gateway/order/{orderId}/obj" to "GET/gateway/order/{orderId}/report-obj". |
| 0.7.37 | 2022-04-07 | Added a new json attribute "smartMeterInstallationDate":"date". Method: <ul style="list-style-type: none"> • GET/gateway/order/{orderId}/report-obj |

| | | |
|--------|------------|--|
| 0.7.38 | 2022-04-12 | Added a new request parameter "interval". Method: <ul style="list-style-type: none"> • POST/gateway/order/{hr15OrderShortName} |
| 0.7.39 | 2022-04-15 | Implemented Order controller methods: <ul style="list-style-type: none"> • POST/gateway/order/list?first={integer}&count={integer}&sortKey={string}&sortOrder={ASC/DSC} • POST/gateway/order/{hr15OrderShortName} • POST/gateway/order/{orderShortName} <p>except:</p> bill-bss-b2b - Billing report for BSS model B2B; bill-bss-b2c - Billing report for BSS model B2C; • GET/gateway/order/{orderId}/data-hr-15min-obj-lvl • GET/gateway/order/{orderId}/data-hr-15min-mtr-lvl • GET/gateway/order/{orderId}/bill-2s2s-b2b • GET/gateway/order/{orderId}/report-obj • GET/gateway/order/{orderId}/count |
| 0.7.40 | 2022-04-22 | Deleted methods: <ul style="list-style-type: none"> • POST /data/data-orders • POST /reports/accounting-data-pack-b2b?first={integer}&count={integer} • POST /reports/accounting-data-pack-b2b-count |
| 0.7.41 | 2022-04-22 | Changed methods: <ul style="list-style-type: none"> • POST /gateway/notification/contract/list?first={integer}&count={integer}&sortOrder={ASC/DSC} • POST /gateway/notification/contract • POST /gateway/notification/{notificationId}/contract/cancel <p>These methods are adapted to the NTK (change of supplier) process. All changes in SK and STK processes, also new rules for NTK process are highlighted in blue.</p> |
| 0.7.42 | 2022-04-27 | Edited 38, 52 rules and 42 error in method: <ul style="list-style-type: none"> • POST /gateway/notification/contract |
| 0.7.43 | 2022-05-03 | Edited 4 rule, 2003 error in the method: <ul style="list-style-type: none"> • POST/gateway/order/{orderShortName} |
| 0.7.44 | 2022-05-03 | Edited 6 rule, 12 error in the method: <ul style="list-style-type: none"> • POST /gateway/declaration/reading/list |
| 0.7.45 | 2022-05-04 | Edited 10 rule in the method: POST /gateway/supplier/send-declaration-data |
| 0.7.46 | 2022-05-04 | <ul style="list-style-type: none"> • Changed url from POST /gateway/declaration/reading/list to POST /gateway/declaration/reading/list?first={integer}&count={integer}&sortKey={string}&sortOrder={ASC/DSC} • Added sort and sortOrder parameters. |

| | | |
|--------|------------|---|
| | | |
| 0.7.47 | 2022-05-05 | Added 68 rule and 134 error in method: <ul style="list-style-type: none"> • POST /gateway/notification/contract |
| 0.7.48 | 2022-05-05 | Edited count default value for these methods: <ul style="list-style-type: none"> • GET/gateway/order/{orderId}/bill-2s2s-b2b • GET/gateway/order/{orderId}/data-hr-15min-mtr-lvl • GET/gateway/order/{orderId}/data-hr-15min-obj-lvl • GET/gateway/order/{orderId}/report-obj • POST/gateway/order/list?first={integer}&count={integer}&sortKey={string}&sortOrder={ASC/DSC} |
| 0.7.49 | 2022-05-09 | Edited 26, 27 rules and 20, 21 errors in method: <ul style="list-style-type: none"> • POST /gateway/notification/contract |
| 0.7.50 | 2022-06-06 | Added new 141, 147, 148 errors in the method: <ul style="list-style-type: none"> • POST /gateway/notification/contract Added new fields representativeName, representativeSurname, representativeDuty in the method: <ul style="list-style-type: none"> • POST /gateway/notification/contract/list?first={integer}&count={integer}&sortOrder={ASC/DSC} Changes are highlighted in blue |
| 0.7.51 | 2022-06-16 | Changed date format of consumptionTime in method: <ul style="list-style-type: none"> • GET/gateway/order/{orderId}/data-hr-15min-mtr-lvl • GET/gateway/order/{orderId}/data-hr-15min-obj-lvl Example of consumptionTime format: 2022-06-07T00:00:00+02:00 2022-06-07T00:00:00+03:00 |
| 0.7.52 | 2022-06-22 | Added json response field "tariffPlan" in method: GET/gateway/order/{orderId}/bill-2s2s-b2b |
| 0.7.53 | 2022-06-28 | Removed method: <ul style="list-style-type: none"> • GET /gateway/supplier/v2/get-declaration-data?first={integer}&count={integer}&customerId={string}&objectNumber={string} |
| 0.7.54 | 2022-06-29 | Added 'objectFutureSupplier' in method: <ul style="list-style-type: none"> • POST /gateway/object/all/active/list?first={integer}&count={integer}&sortKey={string}&sortOrder={ASC/DSC} |
| 0.7.55 | 2022-06-29 | Added new controller "Notification contract controller". <ul style="list-style-type: none"> • Methods in this controller are very similar to method in controller „Contract change notification controller“. Differences are highlighted in green. |

| | | |
|--------|------------|---|
| | | Note: The controller “Contract change notification controller” and its methods will be eliminated after “Notification contract controller” implementation date + 6 months |
| 0.7.56 | 2022-06-29 | Removed errors 112, 116, 108 for NTK (new supplier change) process. Method: <ul style="list-style-type: none"> • POST /gateway/notification/contract |
| 0.7.57 | 2022-06-30 | Added json field ‘anotherSupplierContractCancellation’ in method: <ul style="list-style-type: none"> • POST /gateway/notification/contract/list?first={integer}&count={integer}&sortOrder={ASC/DSC} |
| 0.7.58 | 2022-07-14 | Added json request parameters ‘supplierContractNo’, ‘objectAddressSearch’ in method: <ul style="list-style-type: none"> • POST /gateway/notification/contract/list?first={integer}&count={integer}&sortOrder={ASC/DSC} |
| 0.7.59 | 2022-07-15 | Added new controller “Access right controller – new”. This controller will be deployed in the future, preliminary date – 10.01. |
| 0.7.60 | 2022-07-20 | Added new controller “NotificationCancelation - new” This controller will be deployed in the future, preliminary date – 09.01. Added new controller “Notification contract object supply state controller” This controller will be deployed in the future, preliminary date – 10.01. |
| 0.7.61 | 2022-07-22 | Changed the parameter objectNumber into objectNumbers and a maximum of 500 objects can be specified. Method: <ul style="list-style-type: none"> • POST /gateway/object/all/active/list?first={integer}&count={integer}&sortKey={string}&sortOrder={ASC/DSC} |
| 0.7.62 | 2022-07-25 | Added response the new field “powerPlantType”. Method: <ul style="list-style-type: none"> • POST /gateway/object/all/active/list?first={integer}&count={integer}&sortKey={string}&sortOrder={ASC/DSC} |
| 0.7.63 | 2022-07-27 | Edited rule 21 in method: <ul style="list-style-type: none"> • POST /gateway/notification/contract Edited rule 416 in method: <ul style="list-style-type: none"> • POST /gateway/notification/contract/contact Changes in methods are highlighted in blue. |
| 0.7.64 | 2022-08-05 | Added json field “cancelledByAnotherSupplier“ in method: <ul style="list-style-type: none"> • POST /gateway/notification/contract/list?first={integer}&count={integer}&sortOrder={ASC/DSC} |
| 0.7.65 | 2022-08-25 | Error 116 is returned in NTK (new supplier change) process: <ul style="list-style-type: none"> • POST /gateway/notification/contract |
| 0.7.66 | 2022-08-26 | Edited rule 606 and added 607 rule in method: <ul style="list-style-type: none"> • POST /gateway/notification/cancellation |
| 0.7.67 | 2022-08-31 | Restored the parameter objectNumbers into objectNumber in method: <ul style="list-style-type: none"> • POST /gateway/object/all/active/list?first={integer}&count={integer}&sortKey={string}&sortOrder={ASC/DSC} |
| 0.7.68 | 2022-09-02 | Edited 3001 error message in method: |

| | | |
|--------|------------|--|
| | | <ul style="list-style-type: none"> • POST /gateway/access-right |
| 0.7.69 | 2022-09-07 | Removed "Contract change notification controller" |
| 0.7.70 | 2022-09-20 | Added json field "meterAutomated" and edited 3 rule in method: <ul style="list-style-type: none"> • POST /gateway/declaration/reading/list?first={integer}&count={integer}&sortKey={string}&sortOrder={ASC/DSC} |
| 0.7.71 | 2022-09-30 | Added json field "timeZone" in method: <ul style="list-style-type: none"> • GET/gateway/order/{orderId}/report-obj |
| 0.7.72 | 2022-10-03 | Added new rule 8 in method: <ul style="list-style-type: none"> • POST /gateway/notification/contract/object/supply-state |
| 0.7.73 | 2022-10-04 | Added json field "orderParametersSearch" in method: <ul style="list-style-type: none"> • POST/gateway/order/list?first={integer}&count={integer}&sortKey={string}&sortOrder={ASC/DSC} |
| 0.7.74 | 2022-10-10 | Added the new error message 2007: <ul style="list-style-type: none"> • POST/gateway/order/{hr15OrderShortName} |
| 0.7.75 | 2022-10-11 | Added the new json field "productConsumptionType" in method: <ul style="list-style-type: none"> • GET/gateway/order/{orderId}/bill-2s2s-b2b |
| 0.7.76 | 2022-10-17 | Added the new json field in method: <ul style="list-style-type: none"> • POST /gateway/object/all/active/list?first={integer}&count={integer}&sortKey={string}&sortOrder={ASC/DSC} <p>"metersAmount":"integer", "autoMetersAmount":"integer", "smartMeterInstallationDate":"date", "meterAutomated":"boolean", "automationSystem":"string"</p> |
| 0.7.77 | 2022-10-18 | Added new methods: <ul style="list-style-type: none"> • POST/gateway/order/data-hr-15min-mtr-lvl-acr • POST/gateway/order/data-hr-15min-obj-lvl-acr • POST/gateway/order/data-sum-obj-lvl-acr • POST /gateway/order/report-obj-acr • GET /gateway/order/{orderId}/data-hr-15min-obj-lvl-acr?first={integer}&count={integer} • GET /gateway/order/{orderId}/data-hr-15min-mtr-lvl-acr?first={integer}&count={integer} • GET /gateway/order/{orderId}/report-obj-acr?first={integer}&count={integer} • GET /gateway/order/{orderId}/data-sum-obj-lvl-acr?first={integer}&count={integer} |
| 0.7.78 | 2022-10-24 | Added the new error message 2009: <ul style="list-style-type: none"> • POST/gateway/order/data-sum-obj-lvl-acr |
| 0.7.79 | 2022-10-21 | Added recommendations for SYNC API client |
| 0.7.80 | 2022-10-31 | Added the new error message 320 in method: <ul style="list-style-type: none"> • POST /gateway/notification/contract |
| 0.7.81 | 2022-11-03 | Added json field newPayoffMethod in methods: |

| | | |
|--------|------------|--|
| | | <ul style="list-style-type: none"> • POST /gateway/notification/contract/tariff-plan • POST /gateway/notification/contract/tariff-plan/list??first={integer}&count={integer}&sortKey={string}&sortOrder={ASC/DSC} <p>Added json field payoffMethod in method:</p> <ul style="list-style-type: none"> • POST /gateway/notification/contract/tariff-plan/list??first={integer}&count={integer}&sortKey={string}&sortOrder={ASC/DSC} |
| 0.7.82 | 2022-11-30 | <p>Changed 27, 28 rules in method:</p> <ul style="list-style-type: none"> • POST /gateway/notification/contract |
| 0.7.83 | 2022-12-01 | <p>Added new json field "tariffPlanChangeDate" in method:</p> <ul style="list-style-type: none"> • POST /gateway/object/all/active/list?first={integer}&count={integer}&sortKey={string}&sortOrder={ASC/DSC} |
| 0.7.84 | 2022-12-05 | <p>Removed methods from documentation. Deprecated in the future, preliminary date 2023-02-14, methods:</p> <ul style="list-style-type: none"> • POST /reports/objects-data-pack?first={integer}&count={integer} • POST /reports/objects-data-pack-count |
| 0.7.85 | 2023-01-11 | <p>Changed 21 rule in method:</p> <ul style="list-style-type: none"> • POST /gateway/notification/contract |
| 0.7.86 | 2023-01-17 | <p>Removed 8 error in method:</p> <ul style="list-style-type: none"> • POST /gateway/notification/contract/object/supply-state |
| 0.7.87 | 2023-01-18 | <p>Removed method from documentation. Deprecated in the future, preliminary date 2023-07-18, method:</p> <ul style="list-style-type: none"> • POST /gateway/notification/contract/owner |
| 0.7.88 | 2023-01-23 | <p>Added new rule 2022 in method:</p> <ul style="list-style-type: none"> • GET/gateway/order/{orderId}/data-hr-15min-obj-lvl • GET/gateway/order/{orderId}/data-hr-15min-mtr-lvl • GET/gateway/order/{orderId}/data-hr-15min-obj-lvl-acr • GET/gateway/order/{orderId}/data-hr-15min-mtr-lvl-acr |
| 0.7.89 | 2023-01-25 | <p>Edited 53 rule and 42 error. Added new 54 rule and new 210 error. Method:</p> <ul style="list-style-type: none"> • POST /gateway/notification/contract <p>Added new 26 rule and 210 error. Method:</p> <ul style="list-style-type: none"> • POST /gateway/notification/contract/tariff-plan |
| 0.7.90 | 2023-01-27 | <p>Removed method from documentation:</p> <ul style="list-style-type: none"> • POST/gateway/contract/list?first={integer}&count={integer}&sortKey={string}&sortOrder={ASC/DSC} |
| 0.7.91 | 2023-03-03 | <p>Added json field "valueType" in methods:</p> <ul style="list-style-type: none"> • GET/gateway/order/{orderId}/data-hr-15min-obj-lvl • GET/gateway/order/{orderId}/data-hr-15min-mtr-lvl • GET /gateway/order/{orderId}/data-hr-15min-obj-lvl-acr • GET /gateway/order/{orderId}/data-hr-15min-mtr-lvl-acr |

| | | |
|--------|------------|---|
| 0.7.92 | 2023-03-03 | <p>Added new json response fields in method POST /gateway/object/all/active/list</p> <ul style="list-style-type: none"> • ObjectLatestSupplyState <ul style="list-style-type: none"> ○ State ○ StateValidFrom ○ StateValidTo |
| 0.7.93 | 2023-03-09 | <ul style="list-style-type: none"> • Changed error message (rule No. 73, error code 320) in method POST /gateway/notification/contract • Changed error message (rule No. 24, error code 320) in method POST /gateway/notification/contract/tariff-plan |
| 0.7.94 | 2023-03-10 | <ul style="list-style-type: none"> • Updated rule description (rule No. 21, error code 131) in method POST /gateway/notification/contract |
| 0.7.95 | 2023-03-14 | <ul style="list-style-type: none"> • Removed controller “Supplier change notification controller”. Deprecated in 2023-03-14 |
| 0.7.96 | 2023-03-20 | <p>Added new rule and 608 error code. Method:</p> <ul style="list-style-type: none"> • POST /gateway/notification/cancellation |
| 0.7.97 | 2023-03-20 | <p>Added new json response field:</p> <ul style="list-style-type: none"> • powerPlantObjectNumber <p>in methods:</p> <ul style="list-style-type: none"> • POST /gateway/object/all/active/list • POST /gateway/object/my/active/list |
| 0.7.98 | 2023-03-30 | <p>Added new payoffMethod [S – kWh – PP recovered electricity] in methods:</p> <ul style="list-style-type: none"> • POST /gateway/notification/contract/list • POST /gateway/notification/contract • POST /gateway/notification/contract/tariff-plan/list?first={integer}&count={integer}&sortKey={string}&sortOrder={ASC/DSC} • POST /gateway/object/my/active/list • POST /gateway/object/all/active/list <p>Added new newpayoffMethod [S – kWh – PP recovered electricity] in methods:</p> <ul style="list-style-type: none"> • POST /gateway/notification/contract/tariff-plan/list?first={integer}&count={integer}&sortKey={string}&sortOrder={ASC/DSC} • POST /gateway/notification/contract/tariff-plan |
| 0.7.99 | 2023-04-06 | <p>Added new json response fields:</p> <ul style="list-style-type: none"> • consumptionAverage |

| | | |
|-------|------------|---|
| | | <ul style="list-style-type: none"> consumptionAverageCalculationDate consumptionAverageCalculationMonthsCount <p>In methods:</p> <ul style="list-style-type: none"> POST /gateway/object/my/active/list POST /gateway/object/all/active/list GET/gateway/order/{orderId}/report-obj GET /gateway/order/{orderId}/report-obj-acr |
| 0.8.0 | 2023-04-17 | Removed 73 rule, 320 error. Method: <ul style="list-style-type: none"> POST /gateway/notification/contract |
| 0.8.1 | 2023-05-03 | Added new rules (150 and 151 error code). Method: <ul style="list-style-type: none"> POST /gateway/notification/contract |
| 0.8.2 | 2023-05-03 | Added new rule 2022 in method: <ul style="list-style-type: none"> GET/gateway/order/{orderId}/bill-bss-b2c GET/gateway/order/{orderId}/bill-bss-b2b |
| 0.8.3 | 2023-05-04 | Added recommendations for ASYNC API client |
| 0.8.4 | 2023-05-05 | Added new json response field in method GET/gateway/order/{orderId}/report-obj <ul style="list-style-type: none"> supplierChangeNotificationSubmittedDate |
| 0.8.5 | 2023-05-05 | Added the new json field: <ul style="list-style-type: none"> powerPlantObjectNumber in methods: <ul style="list-style-type: none"> POST /gateway/object/all/active/list POST /gateway/object/my/active/list <p>Will be deployed in 05.23</p> |

Note: Changes in table marked in white are already deployed, marked in green will be deployed in near future.

2. Preface

The Common Data Exchange Platform (hereinafter referred as *DH Platform*) Gateway is a component enabling independent electricity suppliers to directly access DH Platform from within their IT systems and thus helps automate the following business processes:

- Obtaining electricity consumption history data with the purpose of providing commercial proposals for the potential clients – residential and industrial electricity consumers
- Providing information to Distribution System Operator about the new contracts with the clients who have switched their supplier

DH Gateway provides open standards-based interfaces allowing independent suppliers themselves (or with outside assistance) integrate their IT systems with DH Platform.

This document provides technical information on DH Gateway interfaces which is needed to integrate suppliers' information systems with DH Platform.

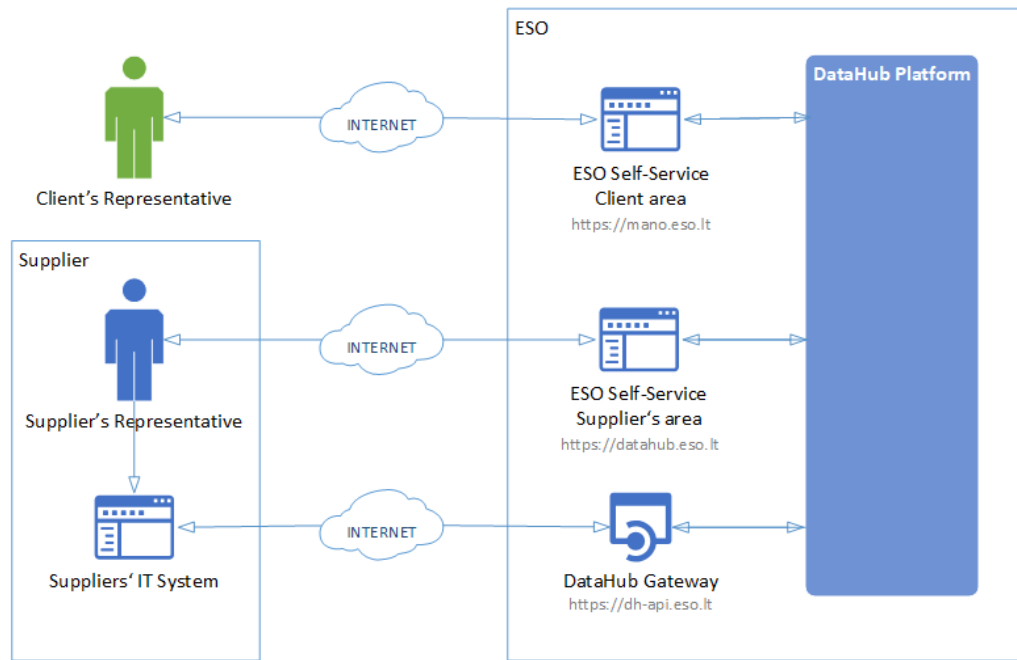

3. Definitions and abbreviations

| Definition / abbreviation | Description |
|---------------------------|---|
| DH Gateway | DH Platform component enabling independent supplier's IT systems to directly access the platform and achieve a higher level degree of process automation. |
| DH, DH Platform | Common Data Exchange Platform. |
| Client | A household or legal person using electricity for the needs of the holding or business. |
| Client's Representative | A household person or his representative Representative of a legal entity (i.e. employee of a legal entity) |
| DSO, ESO | Distribution System Operator – AB „Energijos skirstymo operatorius“ |
| Object | A site where electricity consumption takes place. |
| Supplier | Independent electricity supplier. |

| Definition / abbreviation | Description |
|---------------------------|--|
| Supplier's Representative | Independent electricity supplier's employee representing the supplier. |

4. Environments

There are two DataHub Gateway environments the supplier might access:

- “Sandbox” environment
- Production environment

DataHub Sandbox environment made of Mock API Gateway with mock requests and responses (scenarios). There are no connection to database or any data source, all possible requests and answers are hard-coded into mock API source code and has no any data selection logic or rules. This data is real depersonalized data from DSO customers. Sandbox requests and responses scenarios will be provided in additional document and it should be used just for preparation to integrate with DataHub production API environment or testing purposes.

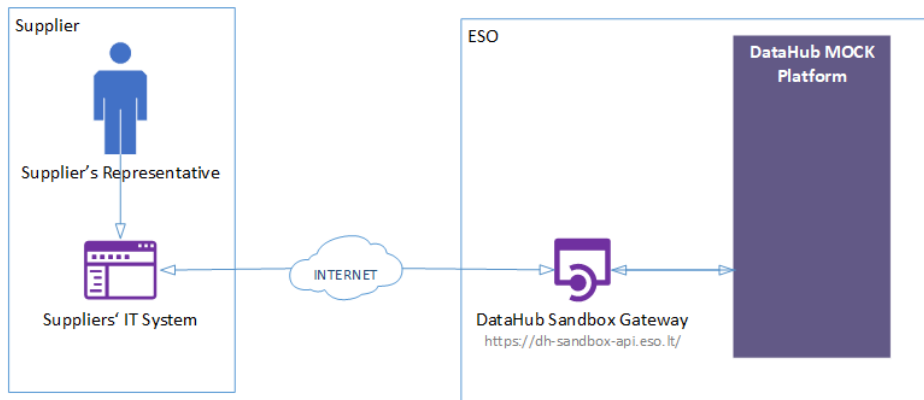

DataHub platform also has WEB interface, which is connected to DataHub Production Gateway. All environments are provided in the table:

| Environment | Link | Swagger Link | WEB Interface |
|-------------|---|---|---|
| Production | https://dh-api.eso.it | https://dh-api.eso.it/swagger-ui.html | https://datahub.eso.it/ |
| Sandbox | https://dh-sandbox-api.eso.it | https://dh-sandbox-api.eso.it/swagger-ui.html | - |
| Sandbox v2 | https://dh-sandbox-api-v2.eso.it/ | https://dh-sandbox-api-v2.eso.it/swagger-ui.html#/ | - |

5. Suppliers' digital certificates

In both the testing and production environments of the DH Gateway component, the identity of the supplier is established using a TOKEN, which the supplier's information system must provide each time the DH Gateway network service is called.

To get started:

1. The DSO responsible person sends the JWT key (JSON Web Token) to be used with each request to the DH API.
2. To make requests to the DataHub Gateway API - the TOKEN submission in the case of cUrl takes place.

```
curl --header 'Authorization: Bearer key_received_from_DSO' https://dh-sandbox-api.eso.lt/data/data-orders/1/data
```

6. Recommendation for API client

6.1 SYNC

Sequential approach with pagination:

Should be default option

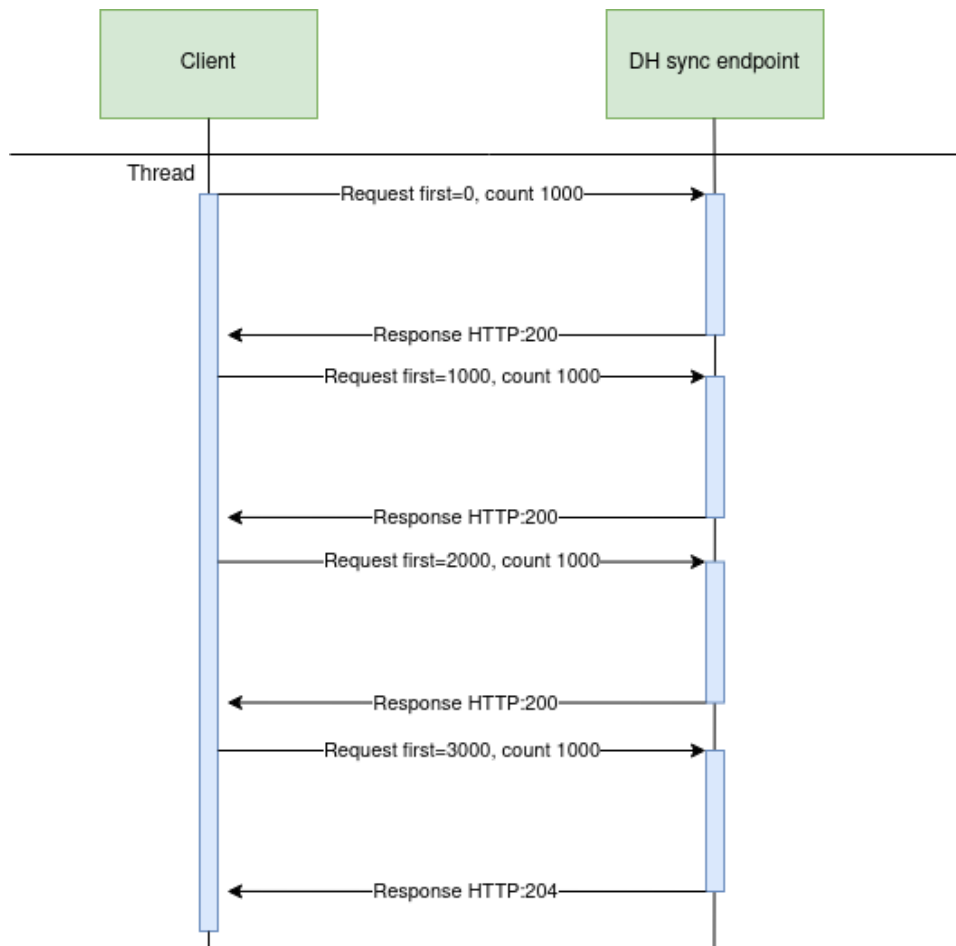

Parallel approach with pagination

Could be used than import time is not reasonable. But parallel requests should be limited.

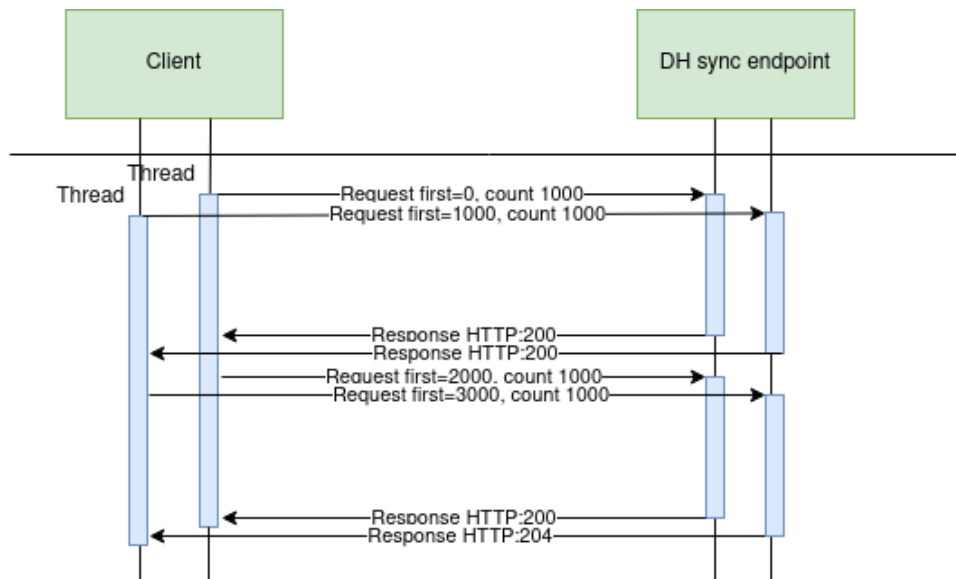

Recommendations for datahub client:

1. Parameter for page size control
2. Parameter for parallel thread amount control
3. Sequentially process should be default, but if import takes too much time, parallel process could be used but with max 3 threads.
4. Page size can be calculated by formula $PS = PST/THRA$, where PS - page size, PST - page size with which request takes less than 15 seconds to execute, THRA - thread amount. But not more than 10 000 records.
5. Retry on HTTP statuses: 429, 5xx
6. Retry should restart failed request only (not whole import process)
7. Retry interval should be not less than 5 seconds.
8. Import process should be able to continue process after failure

Motivation to have these features

1. Performance issues can arise accidentally and solving them can take some time. So, during performance problem page size and thread amount control could help.
2. Datahub has planned and unplanned deployments also can be incidents and during them datahub services might be unavailable. In this case from the client side is nice to have a fallback process which retries failed requests and continues the process after service becomes available again.
3. In the future throttling by independent supplier will be introduced and some of the requests could end up with http status 429 (too many requests) so retry process also will be helpful here.

6.2 ASYNC

Async pattern is mainly used for data orders: <https://dh-api.eso.lt/swagger-ui.html#/public-order-controller>

Client side should implement following process with steps:

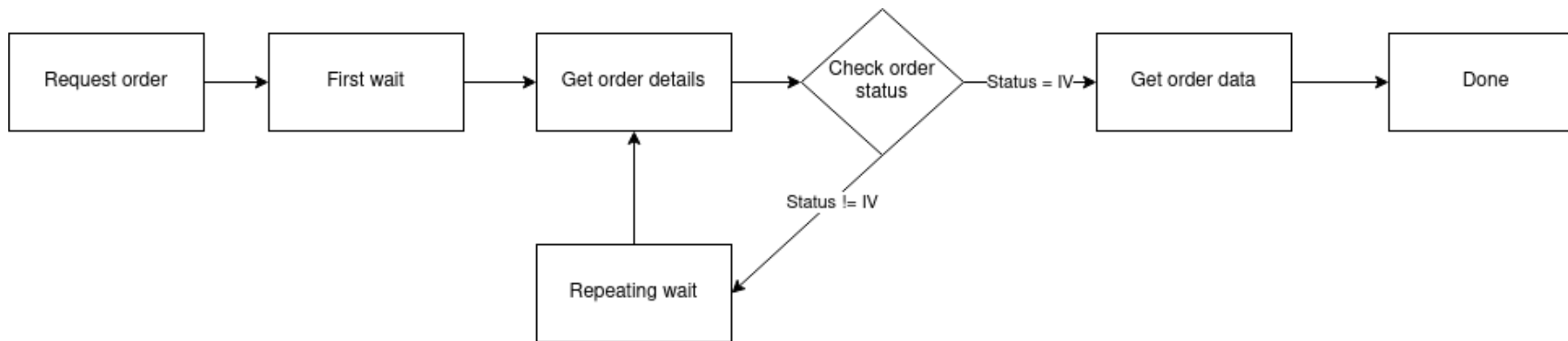

Step descriptions

| Step name | Description | End-point | Request example | Response example |
|---------------|---|---|---|--|
| Request order | Submit new data order. Request will return order id which will be used in other steps for getting order details and order data. | POST /gateway/order/yyyyyyyyyy where yyyyyyyyyy is order type: <ul style="list-style-type: none"> • bill-2s2s-b2b • bill-bss-b2b • bill-bss-b2c • report-obj • data-hr-15min-mtr-lvl • data-hr-15min-mtr-lvl-acr • data-hr-15min-obj-lvl • data-hr-15min-obj-lvl-acr • data-sum-obj-lvl-acr • report-obj-acr | POST /gateway/order/report-obj-acr Body: { "objectNumbers": ["111111111111", "2222222222"] } | HTTP status 201 { "orderId": 10000001 } |
| First wait | Wait for some period of time after order submission. This step is needed because after order request it takes some time to process it and there is no reason to try get status immediately after order submission. First wait duration depends on order type and parameters. If order | | | |

| | | | | |
|--------------------|---|--------------------------|---|---|
| | <p>collects more data it can take minutes to prepare data.</p> <p>For duration recommendations look at 6.2.3 Recommendations.</p> | | | |
| Get order details | <p>Request to get order details. This request is needed to get order latest status which is stored in field "latestStatus".</p> <p>Possible values for "latestStatus":</p> <ul style="list-style-type: none"> • P - Submitted order • V - Order in progress • IV - Order is finished and data are prepared • K - Order has errors | POST /gateway/order/list | <pre>POST /gateway/order/list { "orderId": 10000001 }</pre> | <p>HTTP status 200</p> <pre>[{ "orderId": 10000001, "auto": false, "dateFrom": "2023-04-17", "dateTo": "2023-04-17", "expireDate": "2023-04-18T14:31:27.990Z", "latestStatus": "V", "orderParameters": "{\"objectNumbers\":[\"1111111111111\\\", \"2222222222\"]}", "orderType": "report-obj-acr", "statusDate": "2023-04-17T14:31:27.990Z", "submittedDate": "2023-04-17T14:31:27.990Z", "userName": "PUBLIC" }]</pre> |
| Check order status | <p>Logic operation to check order "latestStatus" field value. If value equals to "IV" it means that order data is prepared. Otherwise order data is not ready algorithm should go to step "Repeating wait".</p> | | | |

| | | | | |
|----------------|---|---|---|---|
| Repeating wait | <p>Wait for some period of time after order status check when status was not equal to "IV". This step is needed because repetitive status check without wait can do unneeded load to DataHub system.</p> <p>For duration recommendations look at 6.2.3 Recommendations.</p> | | | |
| Get order data | <p>Get order data.</p> <p>Note: If order has too many data then pagination should be used. Default and max page size is 10 000 records (usually it's objects).</p> <p>How to get data described in Sync (6.1 SYNC).</p> | <p>GET /gateway/order/zzzzzzzz/yyyyyyyy yy?first=oooooo&count=ssssss</p> <p>where</p> <p>zzzzzzzz is order Id</p> <p>oooooo is offset position</p> <p>ssssss is page size</p> <p>yyyyyyyy is order type:</p> <ul style="list-style-type: none"> • bill-2s2s-b2b • bill-bss-b2b • bill-bss-b2c • report-obj • data-hr-15min-mtr-lvl • data-hr-15min-mtr-lvl-acr • data-hr-15min-obj-lvl • data-hr-15min-obj-lvl-acr • data-sum-obj-lvl-acr • report-obj-acr | <p>GET /gateway/order/10000001/ report-obj- acr?first=0&count=10000</p> | <p>HTTP status 200 with order data in JSON format.</p> <p>If order content is empty get method will return HTTP status 400 with message {"code": 2018, "text": "There is no data for the selected search parameters, the response is empty."}</p> |

6.2.1 DataHub order processing retry policy

If any issues appears during order data processing stage the process stops and order gets status K. DataHub uses retry policy for all orders with status K.

- Retries order process after 5 minutes
- Retries order process 300 times

- For failed orders retry policy will be working in total 25 hours (5 min * 300).
- Retry policy will stop work after 25 hours and order will be left with status K.

This is needed because issues can appear in data preparation stage of couple reasons:

- Datahub techical problem - For example one of datahub integrations was down or contract was changed, data integrity violations and etc
- Incomptable buisness logic - For example order got into not defined use case and use case should be adopted to order.

In most cases order processing retry will solve problem. But there are cases like "Incompatible business logic" when additional human interaction is needed to finish order job. We are tracking such an orders and fix'ing them, but fix'ing might take some some hours or even days. So some orders might not be completed and left in status K.

6.2.2 Order status flows

There are three possible order status flows:

| Flow | Description |
|----------------|---|
| P → V → IV | This is normal status flow. |
| P → V → K → IV | This is flow when issues appear during data preparation, but later problem was fixed. |
| P → V → K | This is flow when issues appear during data preparation and problem was not fixed during datahub retry policy time. |

Order execution duration depends on mutiply factors:

- Order type - different order types uses different integration services some of them are faster some of them are slower.
- Order parameters - order parameters describes how much data will be generated. Bigger order periods and bigger object quantity will be generated longer.
- Order quantity in queue. If independent supplier creates too much orders they will be generated parallely and will take more time to finish them all.
- Failures - Errors during order data preparation will trigger retry policy so order generation will take more time as usually. Some times it will be not generated at all.

6.2.3 Recomendations

1. For better performance "Request order" can be implemented as separate process which is able to create multiple orders.
2. For better performance "Get order details" can be implemented as separate process which is able to get details of multiple orders.
3. For better performance "Get order data" can be implemented as separate process which is able to get order data of multiple orders.
4. For better performance process parallelization could be used but with max 3 threads.
5. Any HTTP request which returns 5xx status can be retried.
6. Any HTTP request which returns 4xx status should stop process because where are business error and manual handling should be used. Except for the step "Get order data" and error "code": 2018, "text": "There is no data for the selected search parameters, the response is empty." It means that order data preparation is finished and order is empty.
7. Step "Request order" and others steps should have separate retries. Get order data on failure should not trigger Request order one more time.
8. It's up to client to decide how long the "First wait" duration can be but it shouldn't be less than 1 second.
9. It's up to client to decide how long the "Repeating wait" duration can be but it shouldn't be less than 1 second.
10. Use fixed number of times for status check. After 25 hours datahub order retry policy will stop working and order will be left in status K. So it reasonable to have number of times equal ((25 hours) / ("Repeating wait" duration in hours)).
11. Do not recreate orders when order got status K. Datahub retry policy will try to get it later or DataHub team member interaction is needed to finish order. Client side solutions will not help to solve status K.
12. For the step "Get order data" use Sync (6.1 SYNC).

7. DataHub Gateway API documentation

7.1 Declaration controller

Declaration controller provides information about API methods intended for objects non smart meters data declaration amount for DSO.

It is recommended to use these methods in Supplier's user interface system or other internal system which collect or allows to provide meter related data. GET and POST methods can be used suppliers Self-Service portals to let suppliers customers declare for them self.

i Declaration data transfer Supplier ↔ DataHub ↔ DSO: Supplier provided data to DataHub Database as soon as possible are transferred to DSO Billing system (it is planning that can be up to 1 hour transaction delay). Every 30min data are synced from DSO Billing system to DataHub DataBase to provide information to Supplier (it is planning that data in DataHub Database can be 0-60min. age comparing with DSO Billing database.)

7.1.1 GET /gateway/supplier/v3/get-declaration-data?first={integer}&count={integer}&customerId={string}&objectNumber={string}

| | |
|--------------------|---|
| URI | GET /gateway/supplier/v3/get-declaration-data?first={integer}&count={integer}&customerId={string}&objectNumber={string} |
| Description | The supplier receives data on the latest known meter scale consumption of its customers objects. |
| Parameters | URL: |

| | | | |
|---------------------|---|---|--|
| | <p>first - index (starting from 0) of the object that must be presented first in the return list. Optional. The default value is 0. count - number of objects in the return list. Optional. The default value is 30. customerId - user code of the contracted customer for data filtering objectNumber - customer object number for data filtering</p> | | |
| Request Body | GET request does not has BODY data model structure. | | |
| Response | HTTP status code | Reason | Response description |
| | 200 | OK | Request completed successfully |
| | 204 | No Content | No data found according to the given parameters. |
| | 400 | Bad Request | Request error. The HTTP response body provides a list of errors in JSON format. |
| | 401 | Unauthorized | An attempt was made to connect to a non-public method that requires authentication, but no user credentials were provided. |
| | 403 | Forbidden | According to the access control policy, the current user does not have access to perform the requested action. |
| | 404 | Not Found | Either there is no API method associated with the request URL path that did not return the data. |
| Rules | No. | Rule description | Attributes |
| | 1. | Customers and their objects belonging to the supplier are selected according to the supplier ID encrypted in the supplier identification key. | Authentication Key |
| | 2. | URL parameters are optional. | URL: first, count, customerId, objectNumber |

| | | |
|----|---|-------------------------|
| | <p>First, count parameters describe a sample of data to return in a single request. By default, the first 30 data of the client object are returned (first: 0, count: 30). If the supplier specifies first, count parameters otherwise, then the data is returned according to the request sent by the supplier, but not more than 50 000;</p> <p> the maximum value per query can be 50 000 objects (max count>=50 000). If the supplier specifies more than 50 000, an error message 12 is displayed.</p> <p>If the vendor does not specify customerId, objectNumber URL parameters, all vendor object scale data (depending on first, count parameters) must be returned to the vendor. If the supplier specifies both parameters, then it is checked whether the specified object number belongs to the specified customer and the scales of a specific object are derived. If an error occurs, error message code 2 is returned.</p> <p>first - index (starting from 0) of the object that must be presented first in the return list. Optional. The default value is 0;</p> <p>count - number of objects in the return list. Optional. The default value is 30;</p> <p>customerId - selection of object scale data according to customer number; By default, the first 30 objects of that client are output;</p> <p>objectNumber - selection of object scale data according to the object number; By default, only the scale data of a specific object is output (First, count parameters lose their effect);</p> | |
| 3. | The method returns only the scales of non-automated meters. | - |
| 4. | The method returns only the valid scales of valid meters. | - |
| 5. | The method returns the latest confirmed (in DSO Billing system) actual readingFrom value, if there are not actual - then average readingFrom value. | readingFrom |
| 6. | The readingMin value is selected from the DSO Billing system and specifies the lowest possible declaration readingTo value. | readingMin, readingTo |
| 7. | The scaleMaxChar value is selected from the DSO Billing system and specifies maximum number of chars which could be provided to readingTo scale field. | readingTo, scaleMaxChar |
| 8. | <p>The method returns the readingSource of the latest confirmed (in DSO Billing system) readingFrom value.</p> <p>The readingSource can be:</p> | readingSource |

A - automatically scanned readings
 D - your declared readings
 L - checked readings
 P - rewritten readings from a previous agreement
 V - average readings
 K - readings from credit document

7.1.1.1 JSON BODY Request structure

The table below describes the JSON structure and elements of the get-declaration-data request BODY:

| JSON Request structure | | | |
|------------------------|------|------------|-------------|
| - | | | |
| Attribute | type | obligation | description |
| - | - | - | - |

7.1.1.2 JSON URL Request structure

The table below describes URL request attributes:

| JSON Request structure | | | |
|------------------------|------------|--------------|--|
| - | | | |
| Attribute | type | obligation | description |
| first | integer | not required | Index (starting from 0) of the object that must be presented first in the return list. |
| count | integer | not required | Number of objects in the return list. |
| customerId | string(32) | not required | Filtering data by supplier-owned user code of the contracted customer. |
| objectNumber | string(20) | not required | Filtering data by supplier-owned customer object number. |

7.1.1.3 JSON Response structure

If the get-declaration-data request is successful, method will return JSON data model which is described below.

JSON Response structure

```
[
{
  "clientId": "string",
  "customerId": "string",
  "clientName": "string",
  "readings":[
  {
    "objectNumber": "string",
    "objectAddress": "string",
    "counterNumber": "string",
    "scaleMaxchar": "number",
    "conversionPoss": "string",
    "scales": [
    {
      "scaleId": "number",
      "scaleIdentifier": "string",
      "scaleType": "string",
      "readingFromDate": "dateTime",
      "readingFrom": "number",
      "readingMin": "number",
      "readingSource": "string"
    }
  ]
  }
  ]
}
]
```

| Attribute | type | obligation | description |
|-------------------|-------------|------------|--|
| clientId | string(20) | required | Client personal code if client is a resident (private customer) company code if client is a company (legal client) |
| customerId | string(32) | required | User code of the contracted customer |
| clientName | string(200) | required | Client name: Name Surname - if household customer Company name - if a legal entity |
| readings[] | | | List of the declaration readings data |

| | | | |
|--|--------------|----------|---|
| readings[].objectNumber | string(20) | required | objectNumber of the object for the supply of electricity in which the contract is concluded. |
| readings[].objectAddress | string(4000) | required | object address |
| readings[].counterNumber | string(20) | required | Meter number which was provided by the manufacturer |
| readings[].scaleMaxchar | number(3) | required | Field specifies maximum number of chars which could be provided i readingTo field. |
| readings[].conversionPoss | boolean | required | Scale possible conversion. Possible values: true - possible conversion false - impossible conversion |
| readings[].scales[] | | | List of the scales |
| readings[].scales[].scaleId | number(8) | required | Scale ID which has to be provided when using POST method. |
| readings[].scales[].scaleIdentifier | string(50) | required | Internal scale identifier. Possible values: VT DD DN +QsumTS +WsumT1 +WsumT2 +WsumT3 +WsumT4 -QsumTS -WsumTS |
| readings[].scales[].scaleType | string(2) | required | Internal scale product type. Possible values (VALUE - explanation): D1 – day electricity D2 – evening electricity DD“ – electricity at day tariff MA- maximum loads MI – minimum loads N1 – night electricity N2 – morning electricity NK – electricity at night, Saturday, Sunday tariff RG- reactive electricity generated |

| | | | |
|--|------------|--------------|--|
| | | | RV – reactive electricity consumption SV – Saturdays, Sundays and holidays electricity VD – average loads VK - one time zone |
| readings[].scales[].readingFromDate | dateTime | required | Date indicating when the last declared reading was registered and confirmed in the ESO Billing system. Last known readingsFrom date. Field format: YYYY-MM-DDThh:mm:ss |
| readings[].scales[].readingFrom | number(18) | required | Last declared reading value |
| readings[].scales[].readingMin | number(18) | not required | The minimum reading that can be provided by the Supplier or the customer in the Supplier Self-Service to the readingTo field in the POST method. |
| readings[].scales[].readingSource | string(1) | required | The reading source of the last declared reading value. Possible values (VALUE - explanation): A - automatically scanned readings D - your declared readings L - checked readings P - rewritten readings from a previous agreement V - average readings K - readings from credit document |

7.1.1.4 Response Error codes

Below are the error codes and messages. Response codes and response content in case of error:

| Code | Message | Explanation |
|------|---|---|
| 2 | "Object <objectNumber> not found or not belongs to You. Please check provided information." | A match between the supplier and the object number could not be found in the DataHub database. |
| 12 | "The maximum number of objects in one request is 50 000." | Supplier provide count attribute value which is more than 50 000. One request can return maximum 50 000 objects' information. |

JSON Response example in case of error

```
{
  "errorMessages": [
    {
```

```

    "code": 0,
    "text": "string"
  }
]
}

```

7.1.2 POST /gateway/declaration/reading/list

| | | | |
|---------------------------|--|---------------|--|
| URL | POST /gateway/declaration/reading/list?first={integer}&count={integer}&sortKey={string}&sortOrder={ASC/DSC} | | |
| Description | The method is intended to obtain the last declared data of the supplier's customer objects. The method is also designed to obtain changes in the declaration data. | | |
| Parameter | <p>URL parameter:</p> <ul style="list-style-type: none"> • first - index (starting from 0) of the object that must be presented first in the return list. Optional. The default value is 0. • count - number of objects in the return list. Optional. The default value is 10 000. • sort - sort the returned records by data. Optional. The default value is `objectNumber`. It can change and sort by `cdcDateTime`. If sort is not provided, the default value applies. • sortOrder - sort by ascending or descending order: ASD / DSC. Optional. The default value is `ASC`. If sortOrder is not provided, the default value applies. | | |
| Header | After decrypting the supplier authentication key, the supplier ID is used to select the data, X-SupplierId. | | |
| Request | <pre> { "objectNumber": "string", "cdcDateTimeFrom": "datetime + timezone", "cdcDateTimeTo": "datetime + timezone" } </pre> | | |
| Response HTTP code | HTTP status code | Reason | Description |
| | 200 | Ok | Request completed successfully. |
| | 204 | No content | No data found according to the given parameters. |

| | | | |
|-----------------------|---|--------------|--|
| | 400 | Bad request | Request error. The HTTP response body provides a list of errors in JSON format. (<i>Error response of the JSON structure below</i>). |
| | 401 | Unauthorized | An attempt was made to connect to a non-public method that requires authentication, but no user credentials were provided. |
| | 403 | Forbidden | According to the access control policy, the current user does not have access to perform the requested action. |
| | 404 | Not Found | Either there is no API method associated with the request URL path, or the request contains one or more parameters that did not return the data. |
| Response | <pre>[{ "objectNumber": "string", "cdcDateTime": "datetime with timezone", "meters": [{ "conversionPoss": true, "meterNumber": "string", "meterScaleLength": number, "meterAutoamted": boolean, "readings": [{ "scaleId": number, "scaleIdentifier": "string", "scaleProduct": "string", "readingFromDate": "datetime", "readingMin": number, "readingFrom": number, "readingSource": "string" }] }] }]</pre> | | |
| Error response | <pre>{ "errorMessages": [{</pre> | | |

```

    "code": 0,
    "text": "string"
  }
]
}

```

| Rule | No. | Rule description | Error code | Error | Attributes |
|------|-----|--|------------|---|---|
| | 1. | Customers and their objects belonging to the supplier are returned according to the supplier ID (X-SupplierId) encrypted in the supplier identification key. | - | - | X-SupplierId, supplier identification key |
| | 2. | The method returns all objects that have signed contracts. | - | - | - |
| | 3. | The method returns only the scales of non-automated meters. All automatic and non-automatic meters are displayed. If an automatic meter is selected, the values "meterAutoamted": true and "readings": null are returned If a non-automatic meter is selected, the values "meterAutoamted": false and "readings": a full object with scales and readings are returned. | - | - | - |
| | 4. | Only valid scales are returned where the current time falls between meter_scale_validity.valid_from and meter_scale_validity.valid_to. | | | scaleId |
| | 5. | Only valid scale types (product types) are returned. | - | - | scaleProduct |
| | 6. | The maximum value per query can be 10 000 objects (max count<=10 000). If the supplier specifies more than 10 000, an error message 12 is displayed. | 12 | The maximum number of objects in one request is 10 000. | - |

7.1.2.1 JSON Request structure

The table below describes the structure of the JSON response:

| No. | Attribute | Type | Obligation | Description |
|-----|-----------------|---------------------|--------------|---|
| 1. | objectNumber | string(20) | not required | Object number. |
| 2. | cdcDateTimeFrom | dateTime + timezone | not required | Change date from of the object (inclusive). |
| 3. | cdcDateTimeTo | dateTime + timezone | not required | Change date to of the object (inclusive). |

7.1.2.2 JSON Response structure

The table below describes the structure of the JSON response:

| No. | Attribute | Type | Obligation | Description |
|-----|------------------|------------------------|------------|---|
| 1. | objectNumber | String(20) | required | Object number. |
| 2. | cdcDateTime | datetime with timezone | required | The last modified date of the object. |
| 3. | meters[] | | | |
| 3.1 | meterNumber | String(20) | required | Meter number. |
| 3.2 | meterScaleLength | Integer | required | Field specifies maximum number of chars which could be provided readingTo field. |
| 3.3 | conversionPoss | boolean | required | Scale possible conversion. Possible values: <ul style="list-style-type: none"> • true - possible conversion • false - impossible conversion |
| 3.4 | meterAutomated | boolean | required | Automated meter feature. |
| 4. | readings[] | | | |
| 4.1 | scaleId | number(8) | required | Scale ID. |
| 4.2 | scaleIdentifier | string(10) | required | Internal scale identifier. Possible values: |

| No. | Attribute | Type | Obligation | Description |
|-----|-----------------|-----------|--------------|---|
| | | | | <ul style="list-style-type: none"> - VT - DD - DN - +QsumTS - +WsumT1 - +WsumT2 - +WsumT3 - +WsumT4 - -QsumTS - -WsumTS |
| 4.3 | scaleProduct | string(2) | required | <p>Internal scale product. Possible values (VALUE - explanation):</p> <ul style="list-style-type: none"> - D1 – day electricity - D2 – evening electricity - DD“ – electricity at day tariff - MA- maximum loads - MI – minimum loads - N1 – night electricity - N2 – morning electricity - NK – electricity at night, Saturday, Sunday tariff - RG- reactive electricity generated - RV – reactive electricity consumption - SV – Saturdays, Sundays and holidays electricity - VD – average loads - VK - one time zone |
| 4.4 | readingFromDate | dateTime | required | <p>Date indicating when the last declared reading was registered and confirmed in the ESO Billing system. Last known readingsFrom date. Field format: YYYY-MM-DDThh:mm:ss</p> |
| 4.5 | readingFrom | number | required | <p>Last declared reading value.</p> |
| 4.6 | readingMin | number | not required | <p>The minimum reading that can be provided by the Supplier or the customer in the Supplier Self-Service to the readingTo field in the POST method.</p> |
| 4.7 | readingSource | string(2) | required | <p>The reading source of the last declared reading value. Possible values (VALUE - explanation):</p> |

| No. | Attribute | Type | Obligation | Description |
|-----|-----------|------|------------|--|
| | | | | <ul style="list-style-type: none"> - A - automatically scanned readings - D - your declared readings - L - checked readings - P - rewritten readings from a previous agreement - V - average readings |

7.1.2.3 Error Response structure

The following table describes the JSON structure in the event of a response error:

| No. | Attribute | Type | Obligation | Description |
|-----|-----------|--------------|------------|----------------|
| 1. | code | number | required | Error code. |
| 2. | text | string(4000) | required | Error message. |

7.1.2.4 Algorithm for using DELTA solution

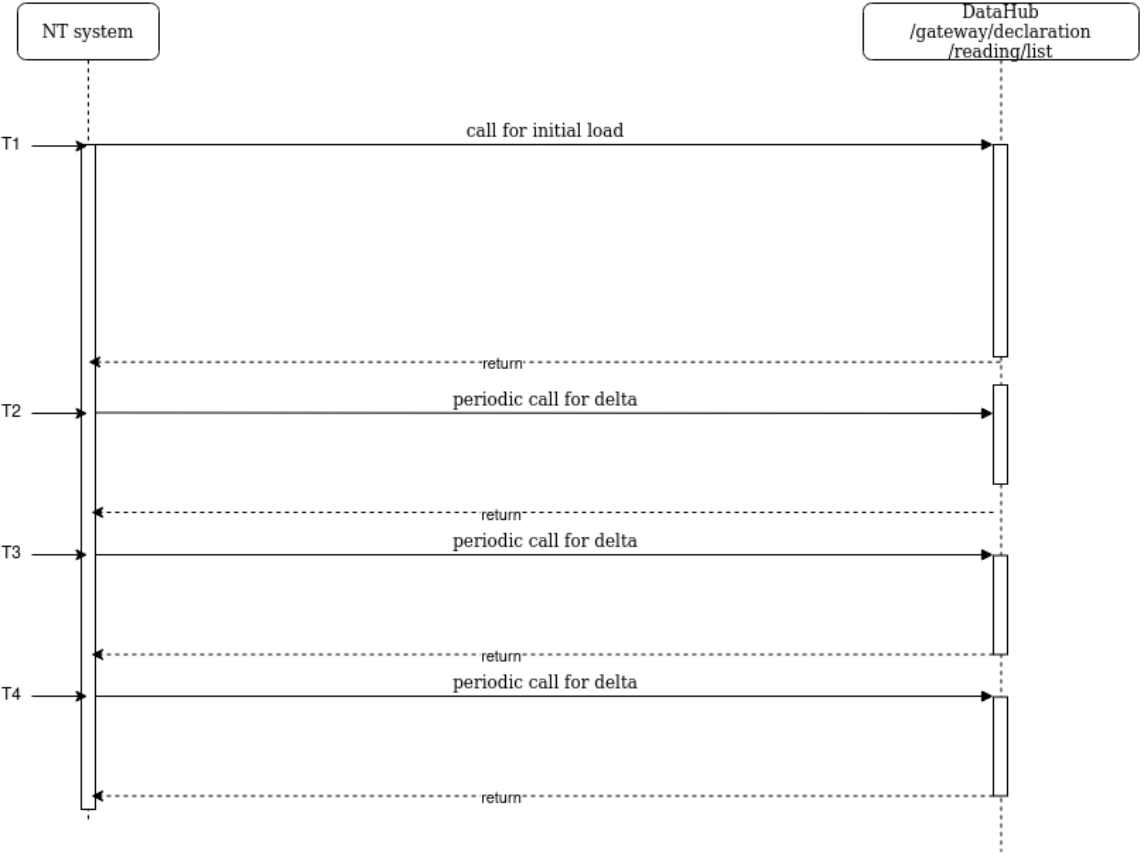

| No. | Instructions for use | Stage | The value of the time variable | Request body |
|-----|--|-----------------|--------------------------------|--------------|
| |  <pre> sequenceDiagram participant NT as NT system participant DataHub as DataHub /gateway/declaration /reading/list Note over NT: T1 NT->>DataHub: call for initial load activate DataHub DataHub-->>NT: return deactivate DataHub Note over NT: T2 NT->>DataHub: periodic call for delta activate DataHub DataHub-->>NT: return deactivate DataHub Note over NT: T3 NT->>DataHub: periodic call for delta activate DataHub DataHub-->>NT: return deactivate DataHub Note over NT: T4 NT->>DataHub: periodic call for delta activate DataHub DataHub-->>NT: return deactivate DataHub </pre> | | | |
| 1. | When starting a solution with the DELTA decision for the first time, an initial load must be performed first. The start time of the initial charge is saved. | Initial loading | TIME = T1 | |

| No. | Instructions for use | Stage | The value of the time variable | Request body |
|-----|--|-----------------|--------------------------------|--------------------------------|
| 2. | A request is sent to get the last declarations for all supplier objects. No parameters are specified in the query. The result is saved. | Initial loading | | {} |
| 3. | After the initial data load, regular data loads continue. The start time of the first regular charge is saved. | Regular loading | TIME = T2 | |
| 4. | A request is sent to receive a change in the declaration data of all the supplier's objects during the time period T2 - T1. In the query parameter cdcDateTimeFrom we specify the time T1. The result is saved. | Regular loading | | { "cdcDateTimeFrom":T1 } |
| 5. | Periodically repeating steps from step 3. | Regular loading | | |

7.1.3 POST /gateway/supplier/send-declaration-data

| | | | |
|---------------------|---|---------------|--------------------------------|
| URI | POST /gateway/supplier/send-declaration-data | | |
| Description | The method is intended to provide readings of the scale declared by the object. The readings are given at the object level, so all counters on the full scale must be presented at the same time. | | |
| Parameters | none | | |
| Request Body | POST request structure provided in BODY | | |
| Response | HTTP status code | Reason | Response description |
| | 201 | Created | Request completed successfully |

| | | | |
|--------------|------------|---|--|
| | 400 | Bad Request | Request error. The HTTP response body provides a list of errors in JSON format. |
| | 401 | Unauthorized | An attempt was made to connect to a non-public method that requires authentication, but no user credentials were provided. |
| | 403 | Forbidden | According to the access control policy, the current user does not have access to perform the requested action. |
| | 404 | Not Found | Either there is no API method associated with the request URL path, or the request contains one or more parameters that did not return the data. |
| Rules | No. | Rule description | Attributes |
| | 0. | If an attribute has defined possible values, the value index can be specified by specifying the value of the attribute in the request. Indices of all possible values start from 0. | All attributes with specified values. |
| | 1. | <p>Customers and their objects belonging to the supplier are selected according to the supplier ID encrypted in the supplier authentication key. It is checked whether the object number belongs to the supplier. If the object does not belong to the same supplier, output an error 10.</p> <p>If the supplier wants to declare the data of the customer who no longer belongs to him, but belonged to the previous month, then the supplier can declare the data for the previous month on the first working day of the next month until 12:59:59 h.</p> | Authentication key, objectNumber |
| | 2. | Checked if all required fields are filled. If on of the field left blank, error 1 is displayed. | All attributes |
| | 3. | <p>The date of the declared reading must be the day of the current month, except for the first working day of the month (it must be calculated when the first working day of the month is taking into account public holidays, eg 2021.01). The declaration must be closed on the first working day of the month at 12:59:59. It also checks that the date and time of dataWriteDate is not a future time compared to the server sysdate.</p> <p>If error occur, error code 3 are displayed.</p> <p>Examples:</p> | dataWriteDate |

| | | |
|----|--|-----------------------|
| | <p>Sysdate 2020-10-01 12:15, dataWriteDate 2020-08-30T16:55:00 Sysdate 2020-10-01 12:15, dataWriteDate 2020-09-01T00:55:00 Sysdate 2020-10-01 12:15, dataWriteDate 2020-10-01T08:00:00 Sysdate 2020-10-01 12:15, dataWriteDate 2020-10-01T08:00:00 Sysdate 2020-10-01 13:05, dataWriteDate 2020-10-01T09:00:00 Sysdate 2020-10-01 13:05, dataWriteDate 2020-09-25T15:55:00 Sysdate 2020-10-01 13:05, dataWriteDate 2020-10-25T08:00:00</p> <p>Lines (2-5) will be accepted, because comply requirement, other lines will be rejected, because period for August (1) and September (6) was closed and (7) because declaration in the future is not possible.</p> <p> Business process: For the reporting month, the declaration may be made no later than the first day of the post-reporting month 13:00:00, indicating that the readings provided is no later than the last day of the reporting month 23:59:59.</p> | |
| 4. | <p>The maximum number of characters in the reading ReadingTo is checked. If the number of characters exceeds the specified number, output error message 4.</p> <p> The verification in the supplier's system shall be performed using the value of readings[].scaleMaxchar obtained in the parameters of the GET method.</p> | readingTo |
| 5. | <p>The scale reading (readingTo) can only be integers (characters are not available). If the display is not an integer or the value has characters, error message no. 5.</p> | readingTo |
| 6. | <p>The data types skllId and dataWriteDate are checked. If the types do not meet the required requirements, message no. 6.</p> | skllId, dataWriteDate |
| 7. | <p>A reading smaller than the readingMin value cannot be declared if no scale conversion occurs. Check that readingTo is greater than or equal to the value of the declared scale readingMin and conversion = N. If scale conversion is possible, then this value may be less than readingMin.</p> <p>If an error occurs, message no. 5.</p> | readingTo, conversion |
| 8. | <p>The conversion indicator may be provided if the "conversationPoss:T" is obtained for the said scale in the GET method and if the estimated consumption is less than half of the maximum consumption of the scale.</p> <p> How the maximum consumption of the scale is calculated. For example, GET method returns "scaleMaxchar:5", then the maximum scale consumption can be 99999.</p> <p>If an error is detected, an error message 7 is displayed.</p> | conversion, readingTo |

| | | |
|-----|---|---|
| 9. | <p>Readings can only be declared for valid scales. Checking that the scaleId of the specified scale is still valid. If the scale is no longer valid, an error message 8 is displayed.</p> <p> This error can usually occur if you make the declaration using data that is out of date.</p> | scaleId |
| 10. | If scaleId could not be found in the database, an error message 8 is displayed. | scaleId |
| 11. | <p>The value of the objectNumber attribute checks whether the user is household or commercial. If the consumer is household, it is permissible to specify the value of readingsTo such that after the mathematical operation readingsTo - readingsFrom <= 20 000 (This parameter is configurable, the value of this parameter can change). (consumption <=20 000 kwh).</p> <p> If the customer is household and the consumption is greater than 20 000 kwh, please contact DSO.</p> <p>If an error occurs, message 9 is displayed.</p> | readingsTo |
| 12. | Checks if the specified objectNumber can be found in the DataHub database. If it cannot be found, an error message 2 is displayed. | objectNumber |
| 13. | <p>It is mandatory to send the scales of all meters in the object at the same time. It is checked whether the supplier sends all the scales assigned to the specific object. The objectNumber selects all valid counters and scales valid in the counters (scaleId) assigned to the object. The declaration takes place in the context of the object and only the ALL scales of ALL the meters in the object are submitted.</p> <p>If at least one scale is missing, an error message is displayed 10.</p> | scaleId, objectNumber |
| 14. | Supplier cannot declare the data for the object if the contractType = SBTS and belongs to the public supplier. An error message 14 is displayed. | objectNumber |
| 15. | Supplier cannot declare the data for the object if the <i>db.object_meter meter_automated is false</i> . An error message 15 is displayed. | scaleId, object_meter_ID, meter_automated |

7.1.3.1 JSON Request structure

The table below describes the JSON structure and elements of the send-declaration-data request:

| |
|------------------------|
| JSON Request structure |
| [{ |

```

"objectNumber": "string",
"dataWriteDate": "date",
"readings":[
{
  "reading": [
    {
      "sklId ": "number",
      "readingTo": "number",
      "conversion": "string"
    }
  ]
}
]
}
]

```

| Attribute | type | obligation | description |
|--|------------|------------|--|
| objectNumber | string(20) | required | objectNumber of the object for the supply of electricity in which the contract is concluded. |
| dataWriteDate | dateTime | required | the date when the meter data was written off Date format: YYYY-MM-DDTHH:mm:ss |
| readings[] | list | required | List of the meters in the object |
| readings[].reading[] | list | required | List of the scales in the meter |
| readings[].reading[].sklId | number | required | scale ID number |
| readings[].reading[].readingTo | number(18) | required | Meter's scale written of value, which is provided by customer or supplier |
| readings[].reading[].conversion | boolean | required | The value of the scale conversion characteristic: true - Yes, there was a conversion false - no, no conversion (default value) |

7.1.3.2 JSON Response structure

If the declaration request is successful, method will not return any data model, but HTTP 201 Created status.

JSON Response structure

If the request is successful, an **HTTP 201 Created** message is returned

| Attribute | type | obligation | description |
|-----------|------|------------|-------------|
| - | - | - | - |

7.1.3.3 Response Error codes

Below are the error codes and messages. Response codes and response content in case of error:

| Code | Message | Explanation |
|------|--|--|
| 4 | "All request parameters are required." | There is no provided one or more required attributes values. |
| 2 | "Object <objectNumber> not found or not belongs to You. Please check provided information." | A match between the supplier and the object number could not be found in the DataHub database. |
| 3 | "Declaration data for the previous reporting period can no longer be provided (period was closed) or Your provide date shows future time." | The supplier tries to provide readings for the previous reporting period or the future. Future declarations are not possible and declarations for the previous reporting period can no longer be provided. |
| 4 | "Incorrect number of digits in readingTo field. Please check maximum number of digits in this scale." | Too many digits on the scale. |
| 5 | "Parameter readingTo is integer and can not be less than value <i>readingMin</i> . Please check this field value." | Only integer values are possible and value has to be greater or equal to readingMin value. |
| 6 | "Incorrect data types." | There was provided incorrect data types in request. |
| 7 | "A conversion indicator may be provided if the estimated consumption is less than half of the maximum consumption of the scale and if the scale has a conversion indicator." | Scale reversal is possible only when the scale has an attribute that indicates the possibility of scale reversal. |
| 8 | "The scale skild does not exist or is no longer valid." | The scale is no longer valid or does not exist. |
| 9 | "Data belongs to household client and declared meter value is more than 20 000. Please check data and try again." | A household customer is trying to declare more than 20 000 kwh. The parameter is configurable, the value of the parameter may change. |

| Code | Message | Explanation |
|------|--|---|
| 10 | "The declaration process is performed in the context of the object. It has to be provided all meters with all scales which belongs to provided object. One of meter or scale is missing or meter automated, please check provided data." | The meter scales are incomplete in the declared data. |
| 11 | "objectNumber and customerId does not exist in DataHub Database." | We were unable to find a match between the object number and the customer code based on the information entered in the URL parameters. |
| 12 | "The maximum number of objects in one request is 50 000." | Supplier provide count attribute value which is more than 50 000. One request can return maximum 50 000 objects information. |
| 13 | "Meter scales with ids <sklid, sklid> are repeating." | Meter scales cannot be repeated for the same object. |
| 14 | Readings not accepted. The object [objectNumber] belongs to a public supplier. | Declare data cannot be declared if the object belongs to a public supplier. |

JSON Response example in case of error

```
{
  "errorMessages": [
    {
      "code": 0,
      "text": "string"
    }
  ]
}
```

7.2 Access right controller

7.2.1 POST/gateway/access-right/list

| | |
|--------------------|--|
| URI | POST /gateway/access-right/list?first={integer}&count={integer}&sortKey={string}&sortOrder={ASC/DSC} |
| Description | The method to obtain information and a list of granted rights. |
| Parameters | URL: |

| | | | |
|---------------------------|--|---------------|--|
| | <ul style="list-style-type: none"> • first - index (starting from 0) of accessRightId that must be presented first in the return list. Optional. The default value is 0. • count - number of accesRightUuid in the return list. Optional. The default value is 30. • sort - optional. The default value is accessRightId • sortOrder - possible values ASD,DSC. Optional. The default value is ASD. <p>The data of the JSON form request are presented in the HTTP request body (BODY) (Query JSON structure, below).</p> | | |
| Header | After decrypting the supplier authentication key, the supplier ID is used to select the data. | | |
| JSON request | <pre>{ "accessRightId":"number" "personCode":"string", "consumerCode":"string", "objectNumber":"string", "objectAddressSearch":"string", "accessRightValidFrom":"date", "accessRightValidTo":"date", "accessRightSource":"string", "generatingObjectType":"string", "contractType":"string", "contractModel":"string", "supplierType":"string", "powerPlantType":"string", "userNameSearch":"string" }</pre> | | |
| Response HTTP code | HTTP status code | Reason | Description |
| | 200 | OK | Request completed successfully |
| | 204 | No Content | No data found according to the given parameters. |
| | 400 | Bad Request | Request error. The HTTP response body provides a list of errors in JSON format. |
| | 401 | Unauthorized | An attempt was made to connect to a non-public method that requires authentication, but no user credentials were provided. |

| | | | |
|----------------------|--|-----------|--|
| | 403 | Forbidden | According to the access control policy, the current user does not have access to perform the requested action. |
| | 404 | Not Found | Either there is no API method associated with the request URL path, or the request contains one or more parameters that did not return the data. |
| JSON response | <pre>[{ "accessRightId":"number", "accessRightValidFrom":"datetime", "accessRightValidTo":"datetime", "daysLeft":"number", "accessRightSource":"string", "userName":"string", "objectNumber":"string", "generatingObjectType":"string", "objectAddress":"string", "contractModel":"string", "supplierType":"string", "tariffPlan":"string", "timeZone":"string", "powerPlantType":"string", "automationLevel":"string", "contractType":"string", "personName":"string", "personSurname":"string", "personCode":"string", "consumerCode":"string", "accessRightPhoneNo":"string", "accessRightEmailAddress":"string", "accessRightNote":"string" }]</pre> | | |

| | | | | | |
|----------------------------|---|---|-------------------|--|-------------------|
| JSON error response | <pre> { "errorMessages": [{ "code": 0, "text": "string" }] } </pre> | | | | |
| Rules | No. | Rule description | Error code | Error message | Attributes |
| | 1. | One or more request parameters are required.. | 1001 | One or more request parameters are required. | - |
| | 2. | DateFrom cannot be later than DateTo. Equal can be. | 1002 | DateFrom cannot be later than DateTo. | - |
| | 3. | Only valid, irrevocable access rights granted must be included in the list. | - | - | - |

7.2.1.1 JSON Request structure

The table below describes the structure of the JSON request:

| No. | Attribute | type | obligation | description |
|-----|---------------|------------|--------------|---------------------------|
| 1. | accessRightId | number | not required | Access right number (ID). |
| 2. | personCode | string(20) | not required | Person code. |
| 3. | consumerCode | string(20) | not required | Consumer code. |
| 4. | objectNumber | string(20) | not required | Object number. |

| No. | Attribute | type | obligation | description |
|-----|----------------------|--------------|--------------|---|
| 5. | objectAddressSearch | string(4000) | not required | Object address search. |
| 6. | accessRightValidFrom | date | not required | Access right valid date From. |
| 7. | accessRightValidTo | date | not required | Access right valid date To. |
| 8. | accessRightSource | string(1) | not required | Access right source. Possible meanings: <ul style="list-style-type: none"> • ESOS – Per ESO-S; • DATAHUB – Per DATA HUB; |
| 9. | generatingObjectType | string(1) | not required | Generating object type. Possible meanings: <ul style="list-style-type: none"> • G – GV (Gaminantis vartotojas); • N – NGV (Nutoles gaminantis vartotojas). |
| 10. | contractType | string(10) | not required | Contract type. Possible meanings: <ul style="list-style-type: none"> • SBTS - Buitinė sutartis; • SKMS - Komercinė sutartis. |
| 11. | contractModel | string(10) | not required | Contract model. Possible meanings: <ul style="list-style-type: none"> • BSS - Bendra sutartis ir sąskaita; • 2S2S - Dvi sutartys – dvi sąskaitos. |
| 12. | supplierType | string(2) | not required | Supplier type. Possible meanings: <ul style="list-style-type: none"> • VT - visuomeninis tiekėjas; • GT - garantinis tiekėjas; • NT - nepriklausomas tiekėjas. |
| 13. | powerPlantType | string(1) | not required | Power plant type. Possible meanings: |

| No. | Attribute | type | obligation | description |
|-----|----------------|-------------|--------------|---|
| | | | | <ul style="list-style-type: none"> • A – Atlieku; • B – Biomasés; • H – Hidroelektrinė; • K – Kita; • S – Saulės; • T – TEC; • V – Vėjo. |
| 14. | userNameSearch | string(240) | not required | User name search. |

7.2.1.2 JSON Request structure

The table below describes the structure of the JSON response:

| No. | Attribute | type | obligation | description |
|-----|----------------------|-------------|--------------|--|
| 1. | accessRightId | number | required | Access right number (ID). |
| 2. | accessRightValidFrom | datetime | required | Access right valid date From. |
| 3. | accessRightValidTo | datetime | required | Access right valid date To. |
| 4. | daysLeft | number | required | Number of days, how long the access right is still valid. |
| 5. | accessRightSource | string(1) | required | Access right source. Possible meanings: <ul style="list-style-type: none"> • ESOS – Per ESO-S; • DATAHUB – Per DATA HUB; |
| 6. | userName | string(240) | required | The user who added the granted right. |
| 7. | objectNumber | string(20) | required | Object number. |
| 8. | generatingObjectType | string(1) | not required | Generating object type. Possible meanings: <ul style="list-style-type: none"> • G – GV (Gaminantis vartotojas); |

| No. | Attribute | type | obligation | description |
|-----|----------------|--------------|--------------|--|
| | | | | <ul style="list-style-type: none"> N – NGV (Nutoļēs gamināntis vartotojas). |
| 9. | objectAddress | string(4000) | required | Object address. |
| 10. | contractModel | String(10) | required | Contract model. Possible meanings: <ul style="list-style-type: none"> BSS - Bendra sutartis ir saskaita; 2S2S - Dvi sutartys – dvi saskaitos. |
| 11. | supplierType | string(2) | required | Supplier type. Possible meanings: <ul style="list-style-type: none"> VT - visuomeninis tiekējas; GT - garantinis tiekējas; NT - nepriklausomas tiekējas. |
| 12. | tariffPlan | String(200) | not required | Tariff plan of object. |
| 13. | timeZone | String(2) | not required | Time zone of object. Possible meanings: <ul style="list-style-type: none"> 1 - One; 2 - Two; VR - One with reactive; 4 - Four (Smart); DR - Differentiated with reactive; N - Not established. |
| 14. | powerPlantType | string(1) | not required | Power plant type. Possible meanings: <ul style="list-style-type: none"> A – Atliekų; B – Biomasės; H – Hidroelektrinė; K – Kita; S – Saulės; T – TEC; V – Vėjo. |

| No. | Attribute | type | obligation | description |
|-----|-------------------------|--------------|--------------|---|
| 15. | automationLevel | string(1) | required | Automation level. Possible meanings: <ul style="list-style-type: none"> • FULL - Pilna; • PARTIAL - Daliné; • NONE - Néra. |
| 16. | contractType | String(10) | required | Contract type. Possible meanings: <ul style="list-style-type: none"> • SBTS - Buitiné sutartis; • SKMS - Komerčiné sutartis. |
| 17. | personName | string(200) | required | Contract owner name / company name. |
| 18. | personSurname | string(50) | not required | Contract owner surname. |
| 19. | personCode | string(20) | required | Person code. |
| 20. | consumerCode | string(20) | required | Consumer code |
| 21. | accessRightPhoneNo | string(12) | not required | Access right phone number. |
| 22. | accessRightEmailAddress | string(100) | not required | Access right phone email address. |
| 23. | accessRightNote | string(4000) | not required | Notes. |

7.2.1.3 Error Response structure

The following table describes the JSON structure in the event of a response error:

| No. | Attribute | type | obligation | description |
|-----|-----------|--------|------------|-------------|
| 1. | code | number | required | Error code. |

| No. | Attribute | type | obligation | description |
|-----|-----------|--------------|------------|----------------|
| 2. | text | string(4000) | required | Error message. |

7.2.2 POST /gateway/access-right

| | | | | |
|---------------------------|---|---------------|--------------------|--|
| URI | POST /gateway/access-right | | | |
| Description | <p>The supplier can grant rights by himself to access clients' historical data if has client agreement.</p> <p>Using this API method, the vendor grants itself the right to access the historical data of the client objects on behalf of the customer. Once the rights have been granted, the supplier can download the customer's historical data for a certain period of time and, on that basis, offer the customer a contract.</p> | | | |
| Parameters | <p>URL: The data of the JSON form request are presented in the HTTP request body (BODY) (Query JSON structure, below).</p> | | | |
| Header | After decrypting the supplier authentication key, the supplier ID is used to select the data. | | | |
| JSON request | <pre>{ "consentSign":"boolean", "personName":"string", "personSurname":"string", "personCode":"string", "personBirthDate":"date", "accessRightInformation":[{ "objectNumber":"string", "accessRightValidTo":"date", "accessRightPhoneNo":"string", "accessRightEmailAddress":"string", "accessRightNote":"string" }] }</pre> | | | |
| Response HTTP code | HTTP status code | Reason | Description | |

| | | | | | |
|----------------------------|---|---|--|---|-------------------|
| | 200 | OK | Request completed successfully | | |
| | 400 | Bad Request | Request error. The HTTP response body provides a list of errors in JSON format. | | |
| | 401 | Unauthorized | An attempt was made to connect to a non-public method that requires authentication, but no user credentials were provided. | | |
| | 403 | Forbidden | According to the access control policy, the current user does not have access to perform the requested action. | | |
| | 404 | Not Found | Either there is no API method associated with the request URL path, or the request contains one or more parameters that did not return the data. | | |
| JSON response | <pre>[{ "accessRightId":"number" }]</pre> | | | | |
| JSON error response | <pre>{ "errorMessages": [{ "code": 0, "text": "string" }] }</pre> | | | | |
| Rules | No. | Rule description | Error code | Error message | Attributes |
| | 1. | The types of existing contracts for the objects must be the same. | 3001 | Access right assign is not possible. Different contract types of objects. | objectNumber |
| | 2. | The attribute [objectNumber] is mandatory. | - | - | objectNumber |

| | | | | | |
|--|---|--|------|---|--|
| | 3. | The meaning of the [objectNumber] cannot be repeated. | 7 | The object: [objectNumber (if there is more than one object, objects must be separated by the semicolon)] is repeating. | objectNumber |
| | | Must be specified valid object. | 8 | The object: [objectNumber (if there is more than one object, objects must be separated by the semicolon)] not found in the system. | objectNumber |
| | | All objects specified in the request must belong to the owner specified in the request, the owner's contract must be valid and signed. | 3007 | The object: [objectNumber (if there is more than one object, objects must be separated by the semicolon)] does not belong to the specified owner / object does not have a valid contract. | personCode, personSurname, personName, personBirthDate, objectNumber |
| | | The attribute [personBirthDate] format must be: yyyy-mm-dd. yyyy - year; mm - month; dd - day. | - | - | personBirthDate |
| | | The attribute [personName] is mandatory. | - | - | personName |
| | | The attributes [personSurname] and [personCode] or [personBirthDate] are mandatory if the object's existing contract type is SBTS. | 3008 | Person surname and personal code or date of birth are required if the contract type is SBTS. | personSurname, personCode, personBirthDate |
| | | The attribute [personCode] is required if the object's existing contract type is SKMS. | 3009 | The company code must be provided if the contract type is SKMS. | personCode |
| | The attribute [accessRightValidTo] format must be: yyyy-mm-dd. yyyy - year; mm - month; dd - day. | - | - | accessRightValidTo | |

| | | | | |
|--|--|------|---|------------------------------------|
| | The attribute [accessRightValidTo] can not be equal to the past date. | 3003 | Access right expire date can not be equal to the past date. | accessRightValidTo |
| | | | | |
| | If the object of the existing contract type is SKMS, then the access right can be granted without restriction to the future. | - | - | accessRightValidTo |
| | If the object of the existing contract type is SBTS, then the maximum access right can be granted for one year, calculated from the current inclusive. | 3004 | If the contract type is SBTS, the maximum access right can be granted for one year. | accessRightValidTo |
| | The format of the attribute [accessRightPhoneNo] must be: +370XXXXXXXXX, X - an integer (0 must be included). | 3005 | Phone no. incorrect format. | accessRightPhoneNo |
| | The format of the attribute [accessRightEmailAddress] must be [text][@][text][.domain], letters in the text must be Latin. | 3006 | Email address incorrect format. | accessRightEmailAddress |
| | If a record has been created for the interested party (independent supplier) and the object and person, it is updated, otherwise a new access right is inserted. | - | - | objectNumber accessRightValidTo |

| | | | | | |
|--|--|---|------|--|-------------|
| | | The meaning of the [consentSign] must be: <ul style="list-style-type: none"> • True or • False. | - | - | consentSign |
| | | If the attribute [consentSign] = False, then the creation must be disabled. | 3010 | It is necessary to confirm that the data provided is correct and the consent of the owner of the object has been obtained. | consentSign |

7.2.2.1 JSON Request structure

The table below describes the structure of the JSON request:

| No. | Attribute | type | obligation | description |
|---------------------------|--------------------|-------------|--------------|--|
| 1. | consentSign | boolean | required | Consent sign. I confirm that the consent of the specified person / company and / or legal basis to receive and process personal / company data has been obtained (person's name, surname / company name, person / company code, address, contact details, facility and electricity consumption data). |
| 2. | personName | string(200) | required | Person name. |
| 3. | personSurname | string(50) | not required | Person surname. |
| 4. | personCode | string(20) | not required | Person code. |
| 5 | personBirthDate | date | not required | Person birth date. |
| accessRightInformation:[] | | | | |
| 6. | objectNumber | string(20) | required | Object number. |
| 7. | accessRightValidTo | date | required | Access right valid date To. |

| No. | Attribute | type | obligation | description |
|-----|-------------------------|--------------|--------------|-----------------------------------|
| 8. | accessRightPhoneNo | string(12) | not required | Access right phone number. |
| 9. | accessRightEmailAddress | string(100) | not required | Access right phone email address. |
| 10. | accessRightNote | string(4000) | not required | Notes. |

7.2.2.2 JSON Request structure

The table below describes the structure of the JSON response:

| No. | Attribute | type | obligation | description |
|-----|---------------|--------|------------|---------------------------|
| 1. | accessRightId | number | required | Access right number (ID). |

7.2.2.3 Error Response structure

The following table describes the JSON structure in the event of a response error:

| No. | Attribute | type | obligation | description |
|-----|-----------|--------------|------------|----------------|
| 1. | code | number | required | Error code. |
| 2. | text | string(4000) | required | Error message. |

7.2.3 POST /gateway/access-right/{accessRightUuid}/cancel

| | |
|--------------------|--|
| URI | POST /gateway/access-right/{accessRightId}/cancel |
| Description | The supplier may remove the rights granted to him. He granted the rights himself with the client's permission, or the rights were granted to him by the client through ESO-S. The supplier can remove remove on rights which was granted by himself. |

| | | | |
|----------------------------|--|---------------|--|
| Parameters | URL: <ul style="list-style-type: none"> accessRightId - access right number (ID). Required | | |
| Header | After decrypting the supplier authentication key, the supplier ID is used to select the data. | | |
| JSON request | | | |
| Response HTTP code | HTTP status code | Reason | Description |
| | 200 | OK | Request completed successfully |
| | 204 | No Content | No data found according to the given parameters. |
| | 400 | Bad Request | Request error. The HTTP response body provides a list of errors in JSON format. |
| | 401 | Unauthorized | An attempt was made to connect to a non-public method that requires authentication, but no user credentials were provided. |
| | 403 | Forbidden | According to the access control policy, the current user does not have access to perform the requested action. |
| | 404 | Not Found | Either there is no API method associated with the request URL path, or the request contains one or more parameters that did not return the data. |
| | 423 | Locked | <p>The source or destination resource of a method is locked.</p> <p>This response SHOULD contain an appropriate precondition or postcondition code, such as 'lock-token-submitted' or 'no-conflicting-lock'.</p> |
| JSON response | | | |
| JSON error response | <pre>{ "errorMessages": [{</pre> | | |

| | <pre> "code": 0, "text": "string" }] } </pre> | | | | |
|-------|--|---|------------|--|---------------|
| Rules | No. | Rule description | Error code | Error message | Attributes |
| | 1. | It must be checked that the access right according to the provided accessRightId exists, is valid at the moment and is not revoked. | 3011 | The access right was not found in the system / it is not valid / is revoked / the right does not belong to the user initiating the action. | accessRightId |
| | 2. | Upon successful revocation, a revocation sign must be affixed. | - | - | - |

7.2.3.1 Error Response structure

The following table describes the JSON structure in the event of a response error:

| No. | Attribute | type | obligation | description |
|-----|-----------|--------------|------------|----------------|
| 1. | code | number | required | Error code. |
| 2. | text | string(4000) | required | Error message. |

7.3 Order controller

7.3.1 POST/gateway/order/list

| | |
|--------------------|--|
| URI | POST/gateway/order/list |
| Description | Method will return list of the orders. |
| Parameters | URL parameters: |

| | | | |
|---------------------|--|---------------|--|
| | <p>first - the index of the report line, which must be the first in the return list (starting from 0). Optional. The default value is 0.</p> <p>count - the number of order's rows in the return list. Optional. The default value is 30. <i>If no count value is given, the default value count will be 30.</i></p> <p>sort – ASC, DSC sorting.</p> <p>-By default, the reports' orders list must be sorted by the orderId;</p> | | |
| Header | After decrypting the supplier authentication key, the supplier ID is used to select the data. | | |
| JSON request | <pre>{ "orderId": "number", "orderTypes": ["string"], "submittedDateFrom": "date", "submittedDateTo": "date", "dateFrom": "date", "dateTo": "date", "status": "string", "auto": "boolean", "userNameSearch": "string", "orderParametersSearch": "string" }</pre> | | |
| Response | HTTP status code | Reason | Response description |
| | 200 | OK | Request completed successfully |
| | 204 | No content | No data found according to the given parameters. |
| | 400 | Bad Request | Request error. The HTTP response body provides a list of errors in JSON format. |
| | 401 | Unauthorized | An attempt was made to connect to a non-public method that requires authentication, but no user credentials were provided. |
| | 403 | Forbidden | According to the access control policy, the current user does not have access to perform the requested action. |
| | 404 | Not Found | Either there is no API method associated with the request URL path, or the request contains one or more parameters that did not return the data. |

| | | | | | |
|----------------------------|--|-------------------------|---|---------------------------------------|------------------|
| JSON Response | <pre>[{ "orderId": "number", "orderType": "string", "submittedDate": "datetime", "dateFrom": "date", "dateTo": "date", "orderParameters": "string", "latestStatus": "string", "statusDate": "datetime", "expireDate": "datetime", "auto": "boolean", "userName": "string" }]</pre> | | | | |
| JSON error response | <pre>{ "errorMessages": [{ "code": 0, "text": "string" }] }</pre> | | | | |
| Rules | No. | Rule description | Error code | Error message | Attribute |
| 0. | If an attribute has defined possible values, the value index can be specified by specifying the value of the attribute in the request. Indices of all possible values start from 0. | - | - | All attributes with specified values. | |
| 1. | DateFrom cannot be later than DateTo. Equal can be. | 1002 | DateFrom cannot be later than DateTo. | dateFrom | |
| 2. | Submitted date cannot be later than the current date but can be equal. | 2004 | Submitted date cannot be later than the current date. | submittedDateTo | |

| | | | | | |
|--|----|---|------|---|--|
| | 3. | Submitted date from cannot be later than the submitted date to, but can be equal. | 2005 | Submitted date from cannot be later than submitted date to. | submittedDateFrom submittedDateTo |
| | 4. | Date format is incorrect. | - | - | dateFrom dateTo submittedDateFrom submittedDateTo |

7.3.1.1 JSON Request structure

The table below describes the structure of the JSON response:

| Attribute | type | obligation | description |
|-------------------|---------|--------------|---|
| orderId | Integer | Not required | Order ID. |
| orderTypes | String | Not required | The short name of the order type. Possible meanings: <ul style="list-style-type: none"> • data-hr-15min-mtr-lvl - Automated quantities at the meter level (Automatizuoti kiekiai skaitiklio lygyje); • data-hr-15min-obj-lvl - Automated quantities at the object level (Automatizuoti kiekiai objekto lygyje); • bill-2s2s-b2b - Billing report for 2S2S model B2B (Sąskaitybos ataskaita 2S2S modeliui B2B); • bill-bss-b2b - Billing report for BSS model B2B (Sąskaitybos ataskaita BSS modeliui B2B); • bill-bss-b2c - Billing report for BSS model B2C (Sąskaitybos ataskaita BSS modeliui B2C); • report-obj - Objects report (Objektų ataskaita). |
| submittedDateFrom | Date | Not required | Order's submission date from. <ul style="list-style-type: none"> • The format of the date: YYYY-MM-DD. |
| submittedDateTo | Date | Not required | Order's submission date to. |
| dateFrom | Date | Not required | The beginning of the reporting period: <ul style="list-style-type: none"> • The format: YYYY-MM-DD; • The reporting period start date is the first day of the month. |
| dateTo | Date | Not required | The end of the reporting period: <ul style="list-style-type: none"> • The format: YYYY-MM-DD; |

| | | | |
|-----------------------|-------------|--------------|--|
| | | | <ul style="list-style-type: none"> The reporting period end date is the last day of the month. |
| status | String(20) | Not required | <p>The status of the order. Possible meanings:</p> <ul style="list-style-type: none"> IV – Completed; V – In progress; P – Submitted; K – Error. |
| auto | Boolean | Not required | Indication that the order was ordered automatically. |
| userNameSearch | String(240) | Not required | The user who ordered the order. |
| orderParametersSearch | String | Not required | The order parameters. |

7.3.1.2 JSON Response structure

The table below describes the structure of the JSON response:

| Attribute | type | obligation | description |
|---------------|-------------|------------|--|
| orderId | Integer | required | Order ID. |
| orderType | String(100) | required | <p>The short name of the order type. Possible meanings:</p> <ul style="list-style-type: none"> data-hr-15min-mtr-lvl - Automated quantities at the meter level (Automatizuoti kiekiai skaitiklio lygyje); data-hr-15min-obj-lvl - Automated quantities at the object level (Automatizuoti kiekiai objekto lygyje); bill-2s2s-b2b - Billing report for 2S2S model B2B (Sąskaitybos ataskaita 2S2S modeliui B2B); bill-bss-b2b - Billing report for BSS model B2B (Sąskaitybos ataskaita BSS modeliui B2B); bill-bss-b2c - Billing report for BSS model B2C (Sąskaitybos ataskaita BSS modeliui B2C); report-obj - Objects report (Objektų ataskaita). |
| submittedDate | Datetime | required | The date of the order submission. |
| dateFrom | Date | required | <p>The beginning of the reporting period:</p> <ul style="list-style-type: none"> The format: YYYY-MM-DD; The reporting period start date is the first day of the month; If the ordered report is Object Automated Consumptions, dateFrom can be not only the first day of the month. |
| dateTo | Date | required | The end of the reporting period: |

| | | | |
|-----------------|--------------|----------|---|
| | | | <ul style="list-style-type: none"> • The format: YYYY-MM-DD; • The reporting period end date is the last day of the month; • If the ordered report is Object Automated Consumptions, dateTo can be not only the last day of the month. |
| orderParameters | String(4000) | required | The search parameters by which the data in the ordered order was filtered. |
| latestStatus | String(20) | required | The current status of the order. |
| statusDate | Datetime | required | The latest status date. |
| expireDate | Datetime | required | Date of validity of the order. <ul style="list-style-type: none"> • The ordered report with status = Completed by default, is available only for 24 hours; • The report, which was generated automatically by default, is available for 12 months. |
| auto | Boolean | required | Indication that the report order was ordered automatically. |
| usreName | String(240) | required | The user who ordered the order. |

7.3.1.3 Error Response Structure

The following table describes the JSON structure in the event of a response error:

| No. | Attribute | type | obligation | description |
|-----|-----------|--------------|------------|----------------|
| 1. | code | number | required | Error code. |
| 2. | text | string(4000) | required | Error message. |

7.3.2 POST/gateway/order/data-hr-15min-mtr-lvl

| | |
|--------------------|--|
| URI | POST/gateway/order/data-hr-15min-mtr-lvl |
| Description | The method is intended for ordering data at the meter level of automated quantities. |
| Parameters | URL: The JSON data is contained in the HTTP request (BODY) (<i>see JSON structure, below</i>). |
| Header | After decrypting the supplier authentication key, the supplier ID is used to select the data. |

| | | | | | |
|----------------------------|--|-------------------------|--|----------------------|-------------------|
| JSON request | <pre>{ "dateFrom": "date", "dateTo": "date", "consumptionCategories":[string, string], "objectNumbers":[string, string], "interval":"string" }</pre> | | | | |
| Response HTTP code | HTTP status code | Reason | Description | | |
| | 201 | Created | The request has been successfully completed. | | |
| | 400 | Bad Request | Request error. The HTTP response body provides a list of errors in JSON format. (<i>Error response of the JSON structure below</i>). | | |
| | 401 | Unauthorized | An attempt was made to connect to a non-public method that requires authentication, but no user credentials were provided. | | |
| | 403 | Forbidden | According to the access control policy, the current user does not have access to perform the requested action. | | |
| | 404 | Not Found | Either there is no API method associated with the request URL path, or the request contains one or more parameters that did not return the data. | | |
| JSON response | <pre>{ "orderId": "number" }</pre> | | | | |
| JSON error response | <pre>{ "errorMessages": [{ "code": 0, "text": "string" }] }</pre> | | | | |
| Rules | No. | Rule description | Error code | Error message | Attributes |

| | | | | |
|-----|---|------|--|---------------------------------------|
| 1. | If an attribute has defined possible values, the value index can be specified by specifying the value of the attribute in the request. Indices of all possible values start from 0. | - | - | All attributes with specified values. |
| 2. | Date format is incorrect. | - | - | dateFrom dateTo |
| 3. | The date from cannot be later than the date to, but can be equal. | 1002 | Date from cannot be later than date to. | dateFrom dateTo |
| 4. | The date from and date to cannot be later than the current date, but can be equal. | 1008 | Date from and date to cannot be later than the current date. | dateFrom |
| 5. | Object meter must be automated. | 2007 | The submitted object number: [objectNumber (if there is more than one object, objects must be separated by the semicolon)], was not found or the meter of object is not automated. | objectNumbers |
| 6. | Data cannot be older than 36 months old. | 2012 | Date from date cannot be older than 36 months old. | dateFrom |
| 7. | Report can be ordered maximum for 12 months. | 2013 | The report can only be ordered for 12 months or less. | dateFrom dateTo |
| 8. | The period date from and date to must be less than date from configurable parameter. | 2015 | Data is not currently available for the selected reporting period. | dateFrom dateTo |
| 11. | A maximum of 500 objects can be submitted in a report order | 2021 | A maximum of 500 objects can be submitted in a report order | objectNumbers |

7.3.2.1 JSON Request structure

The table below describes the structure of the JSON request:

| No. | Attribute | type | obligation | description |
|-----|-----------|------|------------|--|
| 1. | dateFrom | Date | required | The beginning of the reporting period: |

| | | | | |
|----|---------------------|------------|----------|--|
| | | | | <ul style="list-style-type: none"> The format: YYYY-MM-DD; The reporting period start date is the first day of the month. |
| 2. | dateTo | Date | required | The end of the reporting period: <ul style="list-style-type: none"> The format: YYYY-MM-DD; The reporting period end date is the last day of the month. |
| 3. | consumptionCategory | String(20) | required | The consumption category. Possible meanings: <ul style="list-style-type: none"> P+; P-; Q+; Q-; |
| 4. | objectNumbers | String | required | Object number. |
| 5. | interval | String | required | Consumption interval. Possible meanings: <ul style="list-style-type: none"> - HOUR - QUARTER |

7.3.2.2 JSON Response structure

The table below describes the structure of the JSON response:

| No. | Attribute | type | obligation | description |
|-----|-----------|---------|------------|--|
| 1. | orderId | Integer | required | The report ordering primary surrogate key. |

7.3.2.3 Error Response Structure

The following table describes the JSON structure in the event of a response error:

| No. | Attribute | type | obligation | description |
|-----|-----------|--------------|------------|----------------|
| 1. | code | number | required | Error code. |
| 2. | text | string(4000) | required | Error message. |

7.3.3 POST/gateway/order/data-hr-15min-obj-lvl

| | | | |
|----------------------------|--|---------------|--|
| URI | POST/gateway/order/data-hr-15min-obj-lvl | | |
| Description | The method is intended for ordering automated quantities at meter level data. | | |
| Parameters | URL: The JSON data is contained in the HTTP request (BODY) (<i>see JSON structure, below</i>). | | |
| Header | After decrypting the supplier authentication key, the supplier ID is used to select the data. | | |
| JSON request | <pre>{ "dateFrom": "date", "dateTo": "date", "consumptionCategories":[string, string], "objectNumbers":[string, string], "interval":"string" }</pre> | | |
| Response HTTP code | HTTP status code | Reason | Description |
| | 201 | Created | The request has been successfully completed. |
| | 400 | Bad Request | Request error. The HTTP response body provides a list of errors in JSON format. (<i>Error response of the JSON structure below</i>). |
| | 401 | Unauthorized | An attempt was made to connect to a non-public method that requires authentication, but no user credentials were provided. |
| | 403 | Forbidden | According to the access control policy, the current user does not have access to perform the requested action. |
| | 404 | Not Found | Either there is no API method associated with the request URL path, or the request contains one or more parameters that did not return the data. |
| JSON response | <pre>{ "orderId": "number" }</pre> | | |
| JSON error response | <pre>{ "errorMessages": [{ </pre> | | |

```

"code": 0,
"text": "string"
}
]
}

```

| Rules | No. | Rule description | Error code | Error message | Attributes |
|-------|-----|---|------------|--|---------------------------------------|
| | 1. | If an attribute has defined possible values, the value index can be specified by specifying the value of the attribute in the request. Indices of all possible values start from 0. | - | - | All attributes with specified values. |
| | 2. | Date format is incorrect. | - | - | dateFrom dateTo |
| | 3. | The date from cannot be later than the date to, but can be equal. | 1002 | Date from cannot be later than date to. | dateFrom dateTo |
| | 4. | The date from and date to cannot be later than the current date, but can be equal. | 1008 | Date from and date to cannot be later than the current date. | dateFrom |
| | 5. | Object meter must be automated. | 2007 | The submitted object number: [objectNumber (if there is more than one object, objects must be separated by the semicolon)], was not found or the meter of object is not automated. | objectNumbers |
| | 6. | Data cannot be older than 36 months old. | 2012 | Date from date cannot be older than 36 months old. | dateFrom |
| | 7. | Report can be ordered maximum for 12 months. | 2013 | The report can only be ordered for 12 months or less. | dateFrom dateTo |
| | 8. | The period date from and date to must be less than date from configurable parameter. | 2015 | Data is not currently available for the selected reporting period. | dateFrom dateTo |

| | | | | |
|-----|---|------|---|---------------|
| 10. | A maximum of 500 objects can be submitted in a report order | 2021 | A maximum of 500 objects can be submitted in a report order | objectNumbers |
|-----|---|------|---|---------------|

7.3.3.1 JSON Request structure

The table below describes the structure of the JSON request:

| No. | Attribute | type | obligation | description |
|-----|---------------------|------------|------------|---|
| 1. | dateFrom | Date | required | The beginning of the reporting period: <ul style="list-style-type: none"> The format: YYYY-MM-DD; The reporting period start date is the first day of the month. |
| 2. | dateTo | Date | required | The end of the reporting period: <ul style="list-style-type: none"> The format: YYYY-MM-DD; The reporting period end date is the last day of the month. |
| 3. | consumptionCategory | String(20) | required | The consumption category. Possible meanings: <ul style="list-style-type: none"> P+; P-; Q+; Q-; |
| 4. | objectNumbers | String | required | Object number. |
| 5. | interval | String | required | Consumption interval. Possible meanings: <ul style="list-style-type: none"> - HOUR - QUARTER |

7.3.3.2 JSON Response structure

The table below describes the structure of the JSON response:

| No. | Attribute | type | obligation | description |
|-----|-----------|---------|------------|--|
| 1. | orderId | Integer | required | The report ordering primary surrogate key. |

7.3.3.3 Error Response Structure

The following table describes the JSON structure in the event of a response error:

| No. | Attribute | type | obligation | description |
|-----|-----------|--------------|------------|----------------|
| 1. | code | number | required | Error code. |
| 2. | text | string(4000) | required | Error message. |

7.3.4 POST/gateway/order/{orderType}

| | | | |
|---------------------|--|---------------|---|
| URI | POST/gateway/order/{orderType} | | |
| Description | Method will order the chosen report. | | |
| Parameters | URL parameters: <ul style="list-style-type: none"> • orderType – the method is used for specified report type. <ul style="list-style-type: none"> • bill-2s2s-b2b - Billing report for 2S2S model B2B (Sąskaitybos ataskaita 2S2S modeliui B2B); • bill-bss-b2b - Billing report for BSS model B2B (Sąskaitybos ataskaita BSS modeliui B2B); • bill-bss-b2c - Billing report for BSS model B2C (Sąskaitybos ataskaita BSS modeliui B2C); • report-obj - Objects report (Objektų ataskaita). | | |
| Header | After decrypting the supplier authentication key, the supplier ID is used to order the report. | | |
| JSON request | <pre>{ "dateFrom": "date", "dateTo": "date", "consumerCode": "string", "personCode": "string", "objectNumbers":["string"], "contractType": "string" }</pre> | | |
| Response | HTTP status code | Reason | Response description |
| | 201 | Created | Request completed successfully |
| | 400 | Bad Request | Request error. The HTTP response body provides a list of errors in JSON format. |

| | | | | | |
|----------------------------|---|--|--|--|--|
| | 401 | Unauthorized | An attempt was made to connect to a non-public method that requires authentication, but no user credentials were provided. | | |
| | 403 | Forbidden | According to the access control policy, the current user does not have access to perform the requested action. | | |
| | 404 | Not Found | Either there is no API method associated with the request URL path, or the request contains one or more parameters that did not return the data. | | |
| JSON Response | <pre>{ "orderId": "number" }</pre> | | | | |
| JSON error response | <pre>{ "errorMessages": [{ "code": 0, "text": "string" }] }</pre> | | | | |
| Rules | No. | Rule description | Error code | Error message | Attribute |
| | 0. | If an attribute has defined possible values, the value index can be specified by specifying the value of the attribute in the request. Indices of all possible values start from 0. | - | - | All attributes with specified values. |
| | 1. | The report of the specified object can be ordered only if the object was or is owned for the supplier in the chosen period. Checking whether the objects were valid with the supplier during the specified period. | 2001 | There are no owned objects for the selected period or other specified search parameters. | dateFrom dateTo consumerCode objectNumber personCode |
| | 2. | One or more request parameters are required. | 1001 | One or more request parameters are required. | dateFrom dateTo |
| | 3. | DateFrom cannot be later than DateTo. Equal can be. | 1002 | DateFrom cannot be later than DateTo. | dateFrom |

| | | | | |
|-----|---|------|---|--------------------|
| 4. | The date from cannot be later than the current date but can be equal. This rule should not apply to a [report-obj] report, as a result of which the data may be later than the current date. | 2003 | Date from cannot be later than the current date. | dateFrom |
| 5. | Date format is incorrect. | - | - | dateTo dateFrom |
| 6. | The contract type can be specified only for the Object Data Collection report. The contract type cannot be specified for the other order types. | 2008 | The search parameter [contractType] is not applicable to the selected report order type. | contractType |
| 7. | The report order can be done only for one reporting period (one month). <ul style="list-style-type: none"> This rule cannot be applies for [report-obj] report. | 2011 | The report can be ordered only for one month. | dateFrom dateTo |
| 8. | Client information cannot be older than 36 months old. | 2012 | DateFrom date cannot be older than 36 months old. | dateFrom |
| 9. | The period dateFrom and dateTo must be less than date from configurable parameter. | 2015 | Data is not currently available for the selected reporting period. | dateFrom dateTo |
| 10. | Start and end dates are required. | 1004 | Dates are required. | dateFrom dateTo |
| 11. | The object data pack can be ordered 36 months to the future. | 2019 | The report can be ordered 36 months to the future. | dateTo |
| 12. | A maximum of 500 objects can be submitted in a report order | 2021 | A maximum of 500 objects can be specified. | objectNumber |

7.3.4.1 JSON Request structure

The table below describes the structure of the JSON response:

| Attribute | type | obligation | description |
|-----------|------|------------|--|
| dateFrom | Date | Required | The beginning of the reporting period: <ul style="list-style-type: none"> The format: YYYY-MM-DD; The reporting period start date is the first day of the month. |

| | | | |
|---------------|------------|--------------|---|
| dateTo | Date | Required | The end of the reporting period: <ul style="list-style-type: none"> The format: YYYY-MM-DD; The reporting period end date is the last day of the month. |
| consumerCode | String(20) | Not required | Consumer code. |
| personCode | String(20) | Not required | Person or the company code. |
| objectNumbers | String | Not required | Object numbers. |
| contractType | String(10) | Not required | Contract type. Possible meanings: <ul style="list-style-type: none"> SKMS; SBTS. |

7.3.4.2 JSON Response structure

The table below describes the structure of the JSON response:

| Attribute | type | obligation | description |
|-----------|---------|------------|--------------------|
| orderId | Integer | required | Report's order ID. |

7.3.4.3 Error Response Structure

The following table describes the JSON structure in the event of a response error:

| No. | Attribute | type | obligation | description |
|-----|-----------|--------------|------------|----------------|
| 1. | code | number | required | Error code. |
| 2. | text | string(4000) | required | Error message. |

7.3.5 GET/gateway/order/{orderId}/data-hr-15min-obj-lvl

| | |
|--------------------|---|
| URI | GET/gateway/order/{orderId}/data-hr-15min-obj-lvl |
| Description | The method is designed to obtain fifteen minute / hour report data. |
| Parameters | URL parameters: |

| | | | |
|----------------------|---|---------------|--|
| | <p>orderId – order identification number</p> <p>first - the index of the object, which must be the first in the return list (starting from 0). Optional. The default value is 0.</p> <p>count - the number of objects in the return list. Optional. The default value is 10000. If no count value is given, the default value count will be 10000.</p> | | |
| Header | After decrypting the supplier authentication key, the supplier ID is used to select the data. | | |
| JSON request | GET request does not have the BODY part. | | |
| Response | HTTP status code | Reason | Response description |
| | 200 | OK | Request completed successfully |
| | 204 | No content | No data found according to the given parameters. |
| | 400 | Bad Request | Request error. The HTTP response body provides a list of errors in JSON format. |
| | 401 | Unauthorized | An attempt was made to connect to a non-public method that requires authentication, but no user credentials were provided. |
| | 403 | Forbidden | According to the access control policy, the current user does not have access to perform the requested action. |
| | 404 | Not Found | Either there is no API method associated with the request URL path, or the request contains one or more parameters that did not return the data. |
| JSON Response | <pre>[{ "personCode":"string", "personName":"string", "personSurname":"string", "objectId":"number", "objectNumber":"string", "categories":[{ "consumptionCategory":"string", "consumptions":[] }] }]</pre> | | |

| | | | | | |
|----------------------------|--|--|-------------------|---|----------------------|
| | <pre> { "consumptionTime":"datetime", "amount":"double", "valueType":"string" }] }] }] </pre> | | | | |
| JSON error response | <pre> { "errorMessages": [{ "code": 0, "text": "string" }] } </pre> | | | | |
| Rules | No. | Rule description | Error code | Error message | Attribute |
| | 1. | The order status must be Completed. | 2010 | Invalid report order status. | orderId |
| | 2. | According to the submitted order number: [orderId], the order does not exist. | 2016 | Report order doesn't exist in the system. | orderId |
| | 3. | Invalid method selected or parameter specified incorrectly. According to the submitted order number: [orderId] report type is: [orderType] | 2017 | Invalid method selected for report data or incorrect parameter. | orderId orderType |
| | 4. | No data found based on the search parameters submitted in the POST method. | 2018 | There is no data for the selected search parameters, the response is empty. | orderId |
| | 5. | The number of objects in the return list must be less than or equal to 10000. | 2022 | The number of objects on the list has been exceeded. | count |

7.3.5.1 JSON Request structure

The table below describes the structure of the JSON request:

| Attribute | type | obligation | description |
|-----------|------|------------|-------------|
| | | | |

7.3.5.2 JSON Response structure

The table below describes the structure of the JSON response:

| Attribute | type | obligation | description |
|---------------------|-------------|------------|---|
| consumerCode | String(20) | required | Consumer code. |
| personName | String(200) | required | Person name / company name. |
| personSurname | String(50) | required | Person surname. |
| objectId | Integer | required | Object ID. |
| objectNumber | String(20) | required | Object number. |
| categories:[] | | | |
| consumptionCategory | String(20) | required | Consumption category. Possible meanings: <ul style="list-style-type: none"> • P+; • P-; • Q+; • Q-. |
| consumptions:[] | | | |
| consumptionTime | Datetime | required | Consumption time. Example of consumptionTime format: 2022-06-07T00:00:00+02:00 2022-06-07T00:00:00+03:00 |
| amount | Double | required | Consumption amount. |

| | | | |
|-----------|-----------|----------|---|
| valueType | String(3) | required | Consumption value type. Possible meanings: <ul style="list-style-type: none"> • EST – estimated; • VAL – validated. |
|-----------|-----------|----------|---|

7.3.5.3 Error Response Structure

The following table describes the JSON structure in the event of a response error:

| No. | Attribute | type | obligation | description |
|-----|-----------|--------------|------------|----------------|
| 1. | code | number | required | Error code. |
| 2. | text | string(4000) | required | Error message. |

7.3.6 GET/gateway/order/{orderId}/data-hr-15min-mtr-lvl

| | | | |
|---------------------|---|---------------|--------------------------------|
| URI | GET/gateway/order/{orderId}/data-hr-15min-mtr-lvl | | |
| Description | The method is designed to obtain fifteen minute / hour report data. | | |
| Parameters | URL parameters: orderId – order identification number first - the index of the object, which must be the first in the return list (starting from 0). Optional. The default value is 0. count - the number of objects in the return list. Optional. The default value is 10000. If no count value is given, the default value count will be 10000. | | |
| Header | After decrypting the supplier authentication key, the supplier ID is used to select the data. | | |
| JSON request | GET request does not have the BODY part. | | |
| Response | HTTP status code | Reason | Response description |
| | 200 | OK | Request completed successfully |

| | | | |
|--|-----|--------------|--|
| | 204 | No content | No data found according to the given parameters. |
| | 400 | Bad Request | Request error. The HTTP response body provides a list of errors in JSON format. |
| | 401 | Unauthorized | An attempt was made to connect to a non-public method that requires authentication, but no user credentials were provided. |
| | 403 | Forbidden | According to the access control policy, the current user does not have access to perform the requested action. |
| | 404 | Not Found | Either there is no API method associated with the request URL path, or the request contains one or more parameters that did not return the data. |

| | | | |
|----------------------|---|--|--|
| JSON Response | <pre>[{ "personCode":"string", "personName":"string", "personSurname":"string", "objectId":"number", "objectNumber":"string", "meters":[{ "meterNumber":"string", "categories":[{ "consumptionCategory":"string", "consumptions":[{ "consumptionTime":"datetime", "amount":"double", "valueType":"string" }] }] }] }]</pre> | | |
|----------------------|---|--|--|

| | | | | | |
|----------------------------|---|--|-------------------|---|----------------------|
| JSON error response | <pre> { "errorMessages": [{ "code": 0, "text": "string" }] } </pre> | | | | |
| Rules | No. | Rule description | Error code | Error message | Attribute |
| | 1. | The order status must be Completed. | 2010 | Invalid report order status. | orderId |
| | 2. | According to the submitted order number: [orderId], the order does not exist. | 2016 | Report order doesn't exist in the system. | orderId |
| | 3. | Invalid method selected or parameter specified incorrectly. According to the submitted order number: [orderId] report type is: [orderType] | 2017 | Invalid method selected for report data or incorrect parameter. | orderId orderType |
| | 4. | No data found based on the search parameters submitted in the POST method. | 2018 | There is no data for the selected search parameters, the response is empty. | orderId |
| | 5. | The number of objects in the return list must be less than or equal to 10000. | 2022 | The number of objects on the list has been exceeded. | count |

7.3.6.1 JSON Request structure

The table below describes the structure of the JSON request:

| Attribute | type | obligation | description |
|-----------|------|------------|-------------|
| | | | |

7.3.6.2 JSON Response structure

The table below describes the structure of the JSON response:

| Attribute | type | obligation | description |
|-----------|------|------------|-------------|
| | | | |

| | | | |
|---------------------|-------------|----------|---|
| consumerCode | String(20) | required | Consumer code. |
| personName | String(200) | required | Person name / company name. |
| personSurname | String(50) | required | Person surname. |
| objectId | Integer | required | Object ID. |
| objectNumber | String(20) | required | Object number. |
| meters:[] | | | |
| meterNumber | String(20) | required | Meter number of the object. |
| categories:[] | | | |
| consumptionCategory | String(20) | required | Consumption category. Possible meanings: <ul style="list-style-type: none"> • P+; • P-; • Q+; • Q-. |
| Consumptions:[] | | | |
| consumptionTime | Datetime | required | Consumption time. Example of consumptionTime format: 2022-06-07T00:00:00+02:00 2022-06-07T00:00:00+03:00 |
| amount | Double | required | Consumption amount. |
| valueType | String(3) | required | Consumption value type. Possible meanings: <ul style="list-style-type: none"> • EST – estimated; • VAL – validated. |

7.3.6.3 Error Response Structure

The following table describes the JSON structure in the event of a response error:

| No. | Attribute | type | obligation | description |
|-----|-----------|--------|------------|-------------|
| 1. | code | number | required | Error code. |

| No. | Attribute | type | obligation | description |
|-----|-----------|--------------|------------|----------------|
| 2. | text | string(4000) | required | Error message. |

7.3.7 GET/gateway/order/{orderId}/bill-2s2s-b2b

| | | | |
|---------------------|---|---------------|--|
| URI | GET/gateway/order/{orderId}/bill-2s2s-b2b | | |
| Description | The method is used to obtain 2s2s report data. | | |
| Parameters | <p>URL parameters:</p> <p>orderId – order identification number;</p> <p>first - the index of the invoice, which must be the first in the return list (starting from 0). Optional. The default value is 0.</p> <p>count - the number of invoices in the return list. Optional. The default value is 10000. If no count value is given, the default value count will be 10000.</p> | | |
| Header | After decrypting the supplier authentication key, the supplier ID is used to select the data. | | |
| JSON request | GET request does not have the BODY part. | | |
| Response | HTTP status code | Reason | Response description |
| | 200 | OK | Request completed successfully |
| | 204 | No content | No data found according to the given parameters. |
| | 400 | Bad Request | Request error. The HTTP response body provides a list of errors in JSON format. |
| | 401 | Unauthorized | An attempt was made to connect to a non-public method that requires authentication, but no user credentials were provided. |
| | 403 | Forbidden | According to the access control policy, the current user does not have access to perform the requested action. |

| | | | |
|----------------------|---|-----------|--|
| | 404 | Not Found | Either there is no API method associated with the request URL path, or the request contains one or more parameters that did not return the data. |
| JSON Response | <pre>[{ "vatInvoiceNumber":"string", "vatInvoiceSeries":"string", "objects":[{ "contractType":"string", "consumerCode":"string", "personCode":"string", "personName":"string", "personSurname":"string", "objectId":"number", "objectNumber":"string", "objectName":"string", "objectType":"string", "objectAddress":"string", "autoMetersAmount":"number", "products":[{ "billingPeriod":"datetime", "permissiblePowerConsumption":"double", "permissiblePowerGeneration":"double", "generatingObjectType":"string", "tariffPlan":"string", "productCode":"string", "productName":"string", "productType":"string", "consumptionCategory":"string", "consumptionAmount":"double", "unit":"string", "oldIndependentSupplier":"string", "productConsumptionType":"string" }] }] }]</pre> | | |

| | | | | | |
|----------------------------|---|--|-------------------|---|----------------------|
| | <pre>] }] </pre> | | | | |
| JSON error response | <pre> { "errorMessages": [{ "code": 0, "text": "string" }] } </pre> | | | | |
| Rules | No. | Rule description | Error code | Error message | Attribute |
| | 1. | The order status must be Completed. | 2010 | Invalid report order status. | orderId |
| | 2. | According to the submitted order number: [orderId], the order does not exist. | 2016 | Report order doesn't exist in the system. | orderId |
| | 3. | Invalid method selected or parameter specified incorrectly. According to the submitted order number: [orderId] report type is: [orderType] | 2017 | Invalid method selected for report data or incorrect parameter. | orderId orderType |
| | 4. | No data found based on the search parameters submitted in the POST method. | 2018 | There is no data for the selected search parameters, the response is empty. | orderId |

7.3.7.1 JSON Response structure

The table below describes the structure of the JSON response:

| Attribute | type | obligation | description |
|--------------|------------|------------|---|
| contractType | String(10) | required | Contract type. There are 2 possible values: SKMS SBTS |

| | | | |
|-----------------------------|--------------|--------------|---|
| vatInvoiceNumber | String(25) | required | VAT invoice number. |
| vatInvoiceSeries | String(10) | required | VAT invoice series. |
| billingPeriod | datetime | required | Month in which electricity consumption is recorded. |
| consumerCode | String(20) | required | Consumer code. |
| generatingObjectType | String(5) | required | Generating consumer type. Possible meanings: G – GV (Generating consumer); N – NGV (Distant generating consumer). |
| personCode | String(20) | required | Contract owner / tenant person / company code. |
| name | String(200) | required | Contract owner / tenant name / company name. |
| surname | String(50) | Not required | Contract owner / tenant surname. |
| objectId | Number | required | Object Id. |
| objectNumber | String(20) | required | Object number. |
| objectName | String(200) | required | Object name. |
| objectType | String(200) | required | Object type. |
| objectAddress | String(4000) | required | Object address. |
| permissiblePowerConsumption | Double(10,3) | required | Permissible power consumption in the object, kW. |
| permissiblePowerGeneration | Double(10,3) | required | Permissible power generation in the object, kW. |
| autoMetersAmount | Number | required | Total number of remotely readable or smart metering devices installed at the object. |
| oldIndependentSupplier | String(200) | required | Previous supplier of the object. |
| tariffPlan | String(250) | required | The tariff plan of object. |
| productCode | String(20) | required | The code of product. |

| | | | |
|------------------------|--------------|--------------|---|
| productName | String(4000) | required | The product name. |
| productType | String(5) | required | Product type. |
| consumptionCategory | String(2) | required | Category of the consumption energy |
| consumptionAmount | Number | required | The amount of the consumption |
| unit | String(255) | required | The unit of the product. |
| productConsumptionType | String(20) | not required | Type of the product consumption. Possible meanings: <ul style="list-style-type: none"> - AMS - Abonentinis mok. (Subscription fee) - FGS - Sutartiniai fiksuotos galios suvartojimo parametrai (Contractual fixed power consumption parameters) - GGS - Generuojamos galios (Generated power) - LGS - Leistinosios galios (Permissible power) - REPS - Sutartiniai reaktyviosios EE parametrai (Contractual reactive electricity parameters) - SPA - Pagal aktą (According to the act) - SPR - Pagal rodmenis (According to readings) - STA - Pagal taisykles (According to rules) - TSPS - Sutartiniai technologinių sąnaudų parametrai (Contractual technological cost parameters) - VAP - VIAP apskaitos parametrai (VIAP accounting parameters) - SPP - Pagal parametrus (According to parameters) |

7.3.7.2 Error Response Structure

The following table describes the JSON structure in the event of a response error:

| No. | Attribute | type | obligation | description |
|-----|-----------|--------------|------------|----------------|
| 1. | code | number | required | Error code. |
| 2. | text | string(4000) | required | Error message. |

7.3.8 GET/gateway/order/{orderId}/report-obj

| | |
|--------------------|---|
| URI | GET/gateway/order/{orderId}/report-obj |
| Description | The method is used to obtain objects report data. |

| | | | |
|----------------------|---|---------------|--|
| Parameters | URL parameters: orderId – order identification number; first - the index of the report line, which must be the first in the return list (starting from 0). Optional. The default value is 0. count - the number of report rows in the return list. Optional. The default value is 10000. If no count value is given, the default value count will be 10000. | | |
| Header | After decrypting the supplier authentication key, the supplier ID is used to select the data. | | |
| JSON request | GET request does not have the BODY part. | | |
| Response | HTTP status code | Reason | Response description |
| | 200 | OK | Request completed successfully |
| | 204 | No content | No data found according to the given parameters. |
| | 400 | Bad Request | Request error. The HTTP response body provides a list of errors in JSON format. |
| | 401 | Unauthorized | An attempt was made to connect to a non-public method that requires authentication, but no user credentials were provided. |
| | 403 | Forbidden | According to the access control policy, the current user does not have access to perform the requested action. |
| | 404 | Not Found | Either there is no API method associated with the request URL path, or the request contains one or more parameters that did not return the data. |
| JSON Response | <pre>[{ "consumerCode":"string", "personCode":"string", "personName":"string", "personSurname":"string", "objectId":"number", "objectNumber":"string", "objectName":"string", "objectType":"string",</pre> | | |

| | |
|-----------------------------------|--|
| | <pre> "objectAddress": "string", "contractType": "string", "contractModel": "string", "contractStart": "date", "contractEnd": "date", "supplierChangeNotificationSubmittedDate": "date", "permissiblePowerConsumption": "double", "permissiblePowerGeneration": "double", "metersAmount": "number", "autoMetersAmount": "number", "smartMeterInstallationDate": "date", "supplyState": "string", "supplyStateFrom": "date", "supplyStateTo": "date", "consumptionState": "string", "consumptionStateFrom": "date", "consumptionStateTo": "date", "productsAmount": "number", "scalesAmount": "number", "technologicalCosts": "boolean", "payoffMethod": "string", "generatingObjectType": "string", "generatingObjectTypeFrom": "date", "generatingObjectTypeTo": "date", "powerPlantType": "string", "voltage": "double", "tariffPlan": "string", "tariffPlanChangeDate": "date", "timeZone": "string", "consumptionAverage": "double", "consumptionAverageCalculationDate": "datetime", "consumptionAverageCalculationMonthsCount": "integer" }] </pre> |
| <p>JSON error response</p> | <pre> { "errorMessages": [{ "code": 0, "text": "string" }] } </pre> |

| | <pre>] } </pre> | | | | |
|-------|------------------|--|------------|---|----------------------|
| Rules | No. | Rule description | Error code | Error message | Attribute |
| | 1. | The order status must be Completed. | 2010 | Invalid report order status. | orderId |
| | 2. | According to the submitted order number: [orderId], the order does not exist. | 2016 | Report order doesn't exist in the system. | orderId |
| | 3. | Invalid method selected or parameter specified incorrectly. According to the submitted order number: [orderId] report type is: [orderType] | 2017 | Invalid method selected for report data or incorrect parameter. | orderId orderType |
| | 4. | No data found based on the search parameters submitted in the POST method. | 2018 | There is no data for the selected search parameters, the response is empty. | orderId |

7.3.8.1 JSON Response structure

The table below describes the structure of the JSON response:

| Attribute | type | obligation | description |
|-----------|------|------------|--|
| - | - | - | Response description are provided in https://datahub.eso.lt/dokumentacija . In next document version, all fields description will be provided here. |

7.3.8.2 Error Response Structure

The following table describes the JSON structure in the event of a response error:

| No. | Attribute | type | obligation | description |
|-----|-----------|--------------|------------|----------------|
| 1. | code | number | required | Error code. |
| 2. | text | string(4000) | required | Error message. |

7.3.9 GET/gateway/order/{orderId}/bill-bss-b2c - will be deployed in 05.18

| | | | |
|----------------------|---|---------------|--|
| URI | GET/gateway/order/{orderId}/bill-bss-b2c | | |
| Description | The method is used to obtain b2c report data. | | |
| Parameters | URL parameters: orderId – order identification number; first - the index of the report line, which must be the first in the return list (starting from 0). Optional. The default value is 0. count - the number of report rows in the return list. Optional. The default value is 30. | | |
| Header | After decrypting the supplier authentication key, the supplier ID is used to select the data. | | |
| JSON request | GET request does not have the BODY part. | | |
| Response | HTTP status code | Reason | Response description |
| | 200 | OK | Request completed successfully |
| | 204 | No content | No data found according to the given parameters. |
| | 400 | Bad Request | Request error. The HTTP response body provides a list of errors in JSON format. |
| | 401 | Unauthorized | An attempt was made to connect to a non-public method that requires authentication, but no user credentials were provided. |
| | 403 | Forbidden | According to the access control policy, the current user does not have access to perform the requested action. |
| | 404 | Not Found | Either there is no API method associated with the request URL path, or the request contains one or more parameters that did not return the data. |
| JSON Response | <pre>[{ "CustomerID": "string", "ClientID": "string", "ClientName": "string", "ClientAddress": "string", "ObjectID": 0,</pre> | | |

"ObjectNumber": "string",
"ObjectName": "string",
"ObjectType": "string",
"GeneratingCustomer": true,
"ObjectAddress": "string",
"AgreementType": "string",
"AgreementModel": "string",
"AgreementFrom": "2020-09-21",
"AgreementTo": "2020-09-21",
"PermittablePowerConsumption": 0,
"PermittablePowerGeneration": 0,
"InstalledGeneratingPower": 0,
"InstalledConsumptionPower": 0,
"MetersAmount": 0,
"AutoMetersAmount": 0,
"ReportingPeriod": "2020-09-21",
"BillingPeriod": "2020-09-21",
"SupplyState": "string",
"SupplyStateFrom": "2020-09-21",
"SupplyStateTo": "2020-09-21",
"MetersNumber": "string",
"ReadingsSource": "string",
"ReadingsReceiveDate": "2020-09-21",
"PaymentType": "string",
"Service": "string",
"DeclarationReferenceType": "string",
"ReferenceSubmitDate": "2020-09-21",
"ReadingsSubmitDate": "2020-09-21",
"DeclarationReferenceNumber": 0,
"UnaccountedConsumptionActNumber": 0,
"UnaccountedConsumptionActCreateDate": "2020-09-21",
"UnaccountedConsumptionActFrom": "2020-09-21",
"UnaccountedConsumptionActTo": "2020-09-21",
"ConsumptionConversionActNumber": "string",
"ConsumptionConversionActCreateDate": "2020-09-21",
"ConsumptionConversionActFrom": "2020-09-21",
"ConsumptionConversionActTo": "2020-09-21",
"ConsumptionState": "string",
"ConsumptionStateFrom": "2020-09-21",
"ConsumptionStateTo": "2020-09-21",
"TariffPlan": "string",
"TariffPlanChangeDate": "2020-09-21",

"ConsumptionConversionAct": true,
"PowerPlantCapacityDateFrom": "2020-09-21",
"EnergyObtainedDateFrom": "2020-09-21",
"PowerPlantCapacityDateTo": "2020-09-21",
"EnergyObtainedDateTo": "2020-09-21",
"EnergyObtainedPowerKw": 0,
"OperatorGridElectricityPercent": 0,
"ClientGridElectricityPercent": 0,
"VkConsumptionAmount": 0,
"VkViapConsumptionAmount": 0,
"VkSppdConsumptionAmount": 0,
"DdConsumptionAmount": 0,
"DdViapConsumptionAmount": 0,
"DdSppdConsumptionAmount": 0,
"NkConsumptionAmount": 0,
"NkViapConsumptionAmount": 0,
"NkSppdConsumptionAmount": 0,
"N2ConsumptionAmount": 0,
"N2ViapConsumptionAmount": 0,
"N2SppdConsumptionAmount": 0,
"D1ConsumptionAmount": 0,
"D1ViapConsumptionAmount": 0,
"D1SppdConsumptionAmount": 0,
"D2ConsumptionAmount": 0,
"D2ViapConsumptionAmount": 0,
"D2SppdConsumptionAmount": 0,
"N1ConsumptionAmount": 0,
"N1ViapConsumptionAmount": 0,
"N1SppdConsumptionAmount": 0,
"VkConsumedElectricityConsumptionAmount": 0,
"DdConsumedElectricityConsumptionAmount": 0,
"NkConsumedElectricityConsumptionAmount": 0,
"N2ConsumedElectricityConsumptionAmount": 0,
"D1ConsumedElectricityConsumptionAmount": 0,
"D2ConsumedElectricityConsumptionAmount": 0,
"N1ConsumedElectricityConsumptionAmount": 0,
"VkPayingRecoveredEnergyConsumptionAmount": 0,
"DdPayingRecoveredEnergyConsumptionAmount": 0,
"NkPayingRecoveredEnergyConsumptionAmount": 0,
"N2PayingRecoveredEnergyConsumptionAmount": 0,
"D1PayingRecoveredEnergyConsumptionAmount": 0,
"D2PayingRecoveredEnergyConsumptionAmount": 0,

"N1PayingRecoveredEnergyConsumptionAmount": 0,
"VkPayingRecoveredPercentConsumptionAmount": 0,
"DdPayingRecoveredPercentConsumptionAmount": 0,
"NkPayingRecoveredPercentConsumptionAmount": 0,
"N2PayingRecoveredPercentConsumptionAmount": 0,
"D1PayingRecoveredPercentConsumptionAmount": 0,
"D2PayingRecoveredPercentConsumptionAmount": 0,
"N1PayingRecoveredPercentConsumptionAmount": 0,
"VkPayingRecoveredPowerConsumptionAmount": 0,
"DdPayingRecoveredPowerConsumptionAmount": 0,
"NkPayingRecoveredPowerConsumptionAmount": 0,
"N2PayingRecoveredPowerConsumptionAmount": 0,
"D1PayingRecoveredPowerConsumptionAmount": 0,
"D2PayingRecoveredPowerConsumptionAmount": 0,
"N1PayingRecoveredPowerConsumptionAmount": 0,
"VkPayingRecoveredMixedConsumptionAmount": 0,
"DdPayingRecoveredMixedConsumptionAmount": 0,
"NkPayingRecoveredMixedConsumptionAmount": 0,
"N2PayingRecoveredMixedConsumptionAmount": 0,
"D1PayingRecoveredMixedConsumptionAmount": 0,
"D2PayingRecoveredMixedConsumptionAmount": 0,
"N1PayingRecoveredMixedConsumptionAmount": 0,
"VkMissingEnergyConsumptionAmount": 0,
"VkMissingEnergyViapConsumptionAmount": 0,
"VkMissingEnergySppdConsumptionAmount": 0,
"DdMissingEnergyConsumptionAmount": 0,
"DdMissingEnergyViapConsumptionAmount": 0,
"DdMissingEnergySppdConsumptionAmount": 0,
"NkMissingEnergyConsumptionAmount": 0,
"NkMissingEnergyViapConsumptionAmount": 0,
"NkMissingEnergySppdConsumptionAmount": 0,
"N2MissingEnergyConsumptionAmount": 0,
"N2MissingEnergyViapConsumptionAmount": 0,
"N2MissingEnergySppdConsumptionAmount": 0,
"D1MissingEnergyConsumptionAmount": 0,
"D1MissingEnergyViapConsumptionAmount": 0,
"D1MissingEnergySppdConsumptionAmount": 0,
"D2MissingEnergyConsumptionAmount": 0,
"D2MissingEnergyViapConsumptionAmount": 0,
"D2MissingEnergySppdConsumptionAmount": 0,
"N1MissingEnergyConsumptionAmount": 0,
"N1MissingEnergyViapConsumptionAmount": 0,

"N1MissingEnergySppdConsumptionAmount": 0,
"GridSuppliedConsumptionAmount": 0,
"AccumulatedBeginningConsumptionAmount": 0,
"AccumulatedEndConsumptionAmount": 0,
"AccumulatedUploadedConsumptionAmount": 0,
"AccumulatedRaisedConsumptionAmount": 0,
"CompensatedConsumptionAmount": 0,
"OldIndependentSupplier": "string",
"PowerPlantCapacityConsumptionAmount": 0,
"EnergyObtainedConsumptionAmount": 0,
"OperatorGridElectricityConsumptionAmount": 0,
"ClientGridElectricityConsumptionAmount": 0,
"VkUnit": "string",
"VkViapUnit": "string",
"VkSppdUnit": "string",
"DdUnit": "string",
"DdViapUnit": "string",
"DdSppdUnit": "string",
"NkUnit": "string",
"NkViapUnit": "string",
"NkSppdUnit": "string",
"N2Unit": "string",
"N2ViapUnit": "string",
"N2SppdUnit": "string",
"D1Unit": "string",
"D1ViapUnit": "string",
"D1SppdUnit": "string",
"D2Unit": "string",
"D2ViapUnit": "string",
"D2SppdUnit": "string",
"N1Unit": "string",
"N1ViapUnit": "string",
"N1SppdUnit": "string",
"VkConsumedElectricityUnit": "string",
"DdConsumedElectricityUnit": "string",
"NkConsumedElectricityUnit": "string",
"N2ConsumedElectricityUnit": "string",
"D1ConsumedElectricityUnit": "string",
"D2ConsumedElectricityUnit": "string",
"N1ConsumedElectricityUnit": "string",
"VkPayingRecoveredEnergyUnit": "string",
"DdPayingRecoveredEnergyUnit": "string",

"NkPayingRecoveredEnergyUnit": "string",
"N2PayingRecoveredEnergyUnit": "string",
"D1PayingRecoveredEnergyUnit": "string",
"D2PayingRecoveredEnergyUnit": "string",
"N1PayingRecoveredEnergyUnit": "string",
"VkPayingRecoveredPercentUnit": "string",
"DdPayingRecoveredPercentUnit": "string",
"NkPayingRecoveredPercentUnit": "string",
"N2PayingRecoveredPercentUnit": "string",
"D1PayingRecoveredPercentUnit": "string",
"D2PayingRecoveredPercentUnit": "string",
"N1PayingRecoveredPercentUnit": "string",
"VkPayingRecoveredPowerUnit": "string",
"DdPayingRecoveredPowerUnit": "string",
"NkPayingRecoveredPowerUnit": "string",
"N2PayingRecoveredPowerUnit": "string",
"D1PayingRecoveredPowerUnit": "string",
"D2PayingRecoveredPowerUnit": "string",
"N1PayingRecoveredPowerUnit": "string",
"VkPayingRecoveredMixedUnit": "string",
"DdPayingRecoveredMixedUnit": "string",
"NkPayingRecoveredMixedUnit": "string",
"N2PayingRecoveredMixedUnit": "string",
"D1PayingRecoveredMixedUnit": "string",
"D2PayingRecoveredMixedUnit": "string",
"N1PayingRecoveredMixedUnit": "string",
"VkMissingEnergyUnit": "string",
"VkMissingEnergyViapUnit": "string",
"VkMissingEnergySppdUnit": "string",
"DdMissingEnergyUnit": "string",
"DdMissingEnergyViapUnit": "string",
"DdMissingEnergySppdUnit": "string",
"NkMissingEnergyUnit": "string",
"NkMissingEnergyViapUnit": "string",
"NkMissingEnergySppdUnit": "string",
"N2MissingEnergyUnit": "string",
"N2MissingEnergyViapUnit": "string",
"N2MissingEnergySppdUnit": "string",
"D1MissingEnergyUnit": "string",
"D1MissingEnergyViapUnit": "string",
"D1MissingEnergySppdUnit": "string",
"D2MissingEnergyUnit": "string",

"D2MissingEnergyViapUnit": "string",
"D2MissingEnergySppdUnit": "string",
"N1MissingEnergyUnit": "string",
"N1MissingEnergyViapUnit": "string",
"N1MissingEnergySppdUnit": "string",
"VkReadingsFrom": 0,
"DdReadingsFrom": 0,
"NkReadingsFrom": 0,
"N2ReadingsFrom": 0,
"D1ReadingsFrom": 0,
"D2ReadingsFrom": 0,
"N1ReadingsFrom": 0,
"VkConsumedElectricityReadingsFrom": 0,
"DdConsumedElectricityReadingsFrom": 0,
"NkConsumedElectricityReadingsFrom": 0,
"N2ConsumedElectricityReadingsFrom": 0,
"D1ConsumedElectricityReadingsFrom": 0,
"D2ConsumedElectricityReadingsFrom": 0,
"N1ConsumedElectricityReadingsFrom": 0,
"GridSuppliedReadingsFrom": 0,
"VkReadingsTo": 0,
"DdReadingsTo": 0,
"NkReadingsTo": 0,
"N2ReadingsTo": 0,
"D1ReadingsTo": 0,
"D2ReadingsTo": 0,
"N1ReadingsTo": 0,
"VkConsumedElectricityReadingsTo": 0,
"DdConsumedElectricityReadingsTo": 0,
"NkConsumedElectricityReadingsTo": 0,
"N2ConsumedElectricityReadingsTo": 0,
"D1ConsumedElectricityReadingsTo": 0,
"D2ConsumedElectricityReadingsTo": 0,
"N1ConsumedElectricityReadingsTo": 0,
"GridSuppliedReadingsTo": 0,
"VkPriceEur": 0,
"VkViapPriceEur": 0,
"VkSppdPriceEur": 0,
"DdPriceEur": 0,
"DdViapPriceEur": 0,
"DdSppdPriceEur": 0,
"NkPriceEur": 0,

"NkViapPriceEur": 0,
"NkSppdPriceEur": 0,
"N2PriceEur": 0,
"N2ViapPriceEur": 0,
"N2SppdPriceEur": 0,
"D1PriceEur": 0,
"D1ViapPriceEur": 0,
"D1SppdPriceEur": 0,
"D2PriceEur": 0,
"D2ViapPriceEur": 0,
"D2SppdPriceEur": 0,
"N1PriceEur": 0,
"N1ViapPriceEur": 0,
"N1SppdPriceEur": 0,
"VkPayingRecoveredEnergyPriceEur": 0,
"DdPayingRecoveredEnergyPriceEur": 0,
"NkPayingRecoveredEnergyPriceEur": 0,
"N2PayingRecoveredEnergyPriceEur": 0,
"D1PayingRecoveredEnergyPriceEur": 0,
"D2PayingRecoveredEnergyPriceEur": 0,
"N1PayingRecoveredEnergyPriceEur": 0,
"VkPayingRecoveredMixedPriceEur": 0,
"DdPayingRecoveredMixedPriceEur": 0,
"NkPayingRecoveredMixedPriceEur": 0,
"N2PayingRecoveredMixedPriceEur": 0,
"D1PayingRecoveredMixedPriceEur": 0,
"D2PayingRecoveredMixedPriceEur": 0,
"N1PayingRecoveredMixedPriceEur": 0,
"VkMissingEnergyPriceEur": 0,
"VkMissingEnergyViapPriceEur": 0,
"VkMissingEnergySppdPriceEur": 0,
"DdMissingEnergyPriceEur": 0,
"DdMissingEnergyViapPriceEur": 0,
"DdMissingEnergySppdPriceEur": 0,
"NkMissingEnergyPriceEur": 0,
"NkMissingEnergyViapPriceEur": 0,
"NkMissingEnergySppdPriceEur": 0,
"N2MissingEnergyPriceEur": 0,
"N2MissingEnergyViapPriceEur": 0,
"N2MissingEnergySppdPriceEur": 0,
"D1MissingEnergyPriceEur": 0,
"D1MissingEnergyViapPriceEur": 0,

"D1MissingEnergySppdPriceEur": 0,
"D2MissingEnergyPriceEur": 0,
"D2MissingEnergyViapPriceEur": 0,
"D2MissingEnergySppdPriceEur": 0,
"N1MissingEnergyPriceEur": 0,
"N1MissingEnergyViapPriceEur": 0,
"N1MissingEnergySppdPriceEur": 0,
"PowerPlantCapacityPriceEur": 0,
"VkPriceEurVAT": 0,
"VkViapPriceEurVAT": 0,
"VkSppdPriceEurVAT": 0,
"DdPriceEurVAT": 0,
"DdViapPriceEurVAT": 0,
"DdSppdPriceEurVAT": 0,
"NkPriceEurVAT": 0,
"NkViapPriceEurVAT": 0,
"NkSppdPriceEurVAT": 0,
"N2PriceEurVAT": 0,
"N2ViapPriceEurVAT": 0,
"N2SppdPriceEurVAT": 0,
"D1PriceEurVAT": 0,
"D1ViapPriceEurVAT": 0,
"D1SppdPriceEurVAT": 0,
"D2PriceEurVAT": 0,
"D2ViapPriceEurVAT": 0,
"D2SppdPriceEurVAT": 0,
"N1PriceEurVAT": 0,
"N1ViapPriceEurVAT": 0,
"N1SppdPriceEurVAT": 0,
"VkPayingRecoveredEnergyPriceEurVAT": 0,
"DdPayingRecoveredEnergyPriceEurVAT": 0,
"NkPayingRecoveredEnergyPriceEurVAT": 0,
"N2PayingRecoveredEnergyPriceEurVAT": 0,
"D1PayingRecoveredEnergyPriceEurVAT": 0,
"D2PayingRecoveredEnergyPriceEurVAT": 0,
"N1PayingRecoveredEnergyPriceEurVAT": 0,
"VkPayingRecoveredMixedPriceEurVAT": 0,
"DdPayingRecoveredMixedPriceEurVAT": 0,
"NkPayingRecoveredMixedPriceEurVAT": 0,
"N2PayingRecoveredMixedPriceEurVAT": 0,
"D1PayingRecoveredMixedPriceEurVAT": 0,
"D2PayingRecoveredMixedPriceEurVAT": 0,

"N1PayingRecoveredMixedPriceEurVAT": 0,
"VkMissingEnergyPriceEurVAT": 0,
"VkMissingEnergyViapPriceEurVAT": 0,
"VkMissingEnergySppdPriceEurVAT": 0,
"DdMissingEnergyPriceEurVAT": 0,
"DdMissingEnergyViapPriceEurVAT": 0,
"DdMissingEnergySppdPriceEurVAT": 0,
"NkMissingEnergyPriceEurVAT": 0,
"NkMissingEnergyViapPriceEurVAT": 0,
"NkMissingEnergySppdPriceEurVAT": 0,
"N2MissingEnergyPriceEurVAT": 0,
"N2MissingEnergyViapPriceEurVAT": 0,
"N2MissingEnergySppdPriceEurVAT": 0,
"D1MissingEnergyPriceEurVAT": 0,
"D1MissingEnergyViapPriceEurVAT": 0,
"D1MissingEnergySppdPriceEurVAT": 0,
"D2MissingEnergyPriceEurVAT": 0,
"D2MissingEnergyViapPriceEurVAT": 0,
"D2MissingEnergySppdPriceEurVAT": 0,
"N1MissingEnergyPriceEurVAT": 0,
"N1MissingEnergyViapPriceEurVAT": 0,
"N1MissingEnergySppdPriceEurVAT": 0,
"PowerPlantCapacityPriceEurVAT": 0,
"VkDiscount": 0,
"VkViapDiscount": 0,
"VkSppdDiscount": 0,
"DdDiscount": 0,
"DdViapDiscount": 0,
"DdSppdDiscount": 0,
"NkDiscount": 0,
"NkViapDiscount": 0,
"NkSppdDiscount": 0,
"N2Discount": 0,
"N2ViapDiscount": 0,
"N2SppdDiscount": 0,
"D1Discount": 0,
"D1ViapDiscount": 0,
"D1SppdDiscount": 0,
"D2Discount": 0,
"D2ViapDiscount": 0,
"D2SppdDiscount": 0,
"N1Discount": 0,

"N1ViapDiscount": 0,
"N1SppdDiscount": 0,
"VkPayingRecoveredEnergyDiscount": 0,
"VkPayingRecoveredMixedDiscount": 0,
"VkMissingEnergyDiscount": 0,
"VkMissingEnergyViapDiscount": 0,
"VkMissingEnergySppdDiscount": 0,
"FixedFeeAmountNoVAT": 0,
"VkAmountNoVAT": 0,
"VkViapAmountNoVAT": 0,
"VkSppdAmountNoVAT": 0,
"DdAmountNoVAT": 0,
"DdViapAmountNoVAT": 0,
"DdSppdAmountNoVAT": 0,
"NkAmountNoVAT": 0,
"NkViapAmountNoVAT": 0,
"NkSppdAmountNoVAT": 0,
"N2AmountNoVAT": 0,
"N2ViapAmountNoVAT": 0,
"N2SppdAmountNoVAT": 0,
"D1AmountNoVAT": 0,
"D1ViapAmountNoVAT": 0,
"D1SppdAmountNoVAT": 0,
"D2AmountNoVAT": 0,
"D2ViapAmountNoVAT": 0,
"D2SppdAmountNoVAT": 0,
"N1AmountNoVAT": 0,
"N1ViapAmountNoVAT": 0,
"N1SppdAmountNoVAT": 0,
"VkPayingRecoveredEnergyAmountNoVAT": 0,
"DdPayingRecoveredEnergyAmountNoVAT": 0,
"NkPayingRecoveredEnergyAmountNoVAT": 0,
"N2PayingRecoveredEnergyAmountNoVAT": 0,
"D1PayingRecoveredEnergyAmountNoVAT": 0,
"D2PayingRecoveredEnergyAmountNoVAT": 0,
"N1PayingRecoveredEnergyAmountNoVAT": 0,
"VkPayingRecoveredMixedAmountNoVAT": 0,
"DdPayingRecoveredMixedAmountNoVAT": 0,
"NkPayingRecoveredMixedAmountNoVAT": 0,
"N2PayingRecoveredMixedAmountNoVAT": 0,
"D1PayingRecoveredMixedAmountNoVAT": 0,
"D2PayingRecoveredMixedAmountNoVAT": 0,

"N1PayingRecoveredMixedAmountNoVAT": 0,
"VkMissingEnergyAmountNoVAT": 0,
"VkMissingEnergyViapAmountNoVAT": 0,
"VkMissingEnergySppdAmountNoVAT": 0,
"DdMissingEnergyAmountNoVAT": 0,
"DdMissingEnergyViapAmountNoVAT": 0,
"DdMissingEnergySppdAmountNoVAT": 0,
"NkMissingEnergyAmountNoVAT": 0,
"NkMissingEnergyViapAmountNoVAT": 0,
"NkMissingEnergySppdAmountNoVAT": 0,
"N2MissingEnergyAmountNoVAT": 0,
"N2MissingEnergyViapAmountNoVAT": 0,
"N2MissingEnergySppdAmountNoVAT": 0,
"D1MissingEnergyAmountNoVAT": 0,
"D1MissingEnergyViapAmountNoVAT": 0,
"D1MissingEnergySppdAmountNoVAT": 0,
"D2MissingEnergyAmountNoVAT": 0,
"D2MissingEnergyViapAmountNoVAT": 0,
"D2MissingEnergySppdAmountNoVAT": 0,
"N1MissingEnergyAmountNoVAT": 0,
"N1MissingEnergyViapAmountNoVAT": 0,
"N1MissingEnergySppdAmountNoVAT": 0,
"PowerPlantCapacityAmountNoVAT": 0,
"FixedFeeAmount": 0,
"VkAmount": 0,
"VkViapAmount": 0,
"VkSppdAmount": 0,
"DdAmount": 0,
"DdViapAmount": 0,
"DdSppdAmount": 0,
"NkAmount": 0,
"NkViapAmount": 0,
"NkSppdAmount": 0,
"N2Amount": 0,
"N2ViapAmount": 0,
"N2SppdAmount": 0,
"D1Amount": 0,
"D1ViapAmount": 0,
"D1SppdAmount": 0,
"D2Amount": 0,
"D2ViapAmount": 0,
"D2SppdAmount": 0,

"N1Amount": 0,
"N1ViapAmount": 0,
"N1SppdAmount": 0,
"VkPayingRecoveredEnergyAmount": 0,
"DdPayingRecoveredEnergyAmount": 0,
"NkPayingRecoveredEnergyAmount": 0,
"N2PayingRecoveredEnergyAmount": 0,
"D1PayingRecoveredEnergyAmount": 0,
"D2PayingRecoveredEnergyAmount": 0,
"N1PayingRecoveredEnergyAmount": 0,
"VkPayingRecoveredMixedAmount": 0,
"DdPayingRecoveredMixedAmount": 0,
"NkPayingRecoveredMixedAmount": 0,
"N2PayingRecoveredMixedAmount": 0,
"D1PayingRecoveredMixedAmount": 0,
"D2PayingRecoveredMixedAmount": 0,
"N1PayingRecoveredMixedAmount": 0,
"VkMissingEnergyAmount": 0,
"VkMissingEnergyViapAmount": 0,
"VkMissingEnergySppdAmount": 0,
"DdMissingEnergyAmount": 0,
"DdMissingEnergyViapAmount": 0,
"DdMissingEnergySppdAmount": 0,
"NkMissingEnergyAmount": 0,
"NkMissingEnergyViapAmount": 0,
"NkMissingEnergySppdAmount": 0,
"N2MissingEnergyAmount": 0,
"N2MissingEnergyViapAmount": 0,
"N2MissingEnergySppdAmount": 0,
"D1MissingEnergyAmount": 0,
"D1MissingEnergyViapAmount": 0,
"D1MissingEnergySppdAmount": 0,
"D2MissingEnergyAmount": 0,
"D2MissingEnergyViapAmount": 0,
"D2MissingEnergySppdAmount": 0,
"N1MissingEnergyAmount": 0,
"N1MissingEnergyViapAmount": 0,
"N1MissingEnergySppdAmount": 0,
"PowerPlantCapacityAmount": 0,
"FixedFeeIncludedVAT": "string",
"VkIncludedVAT": "string",
"VkViapIncludedVAT": "string",

"VkSppdIncludedVAT": "string",
"DdIncludedVAT": "string",
"DdViapIncludedVAT": "string",
"DdSppdIncludedVAT": "string",
"NkIncludedVAT": "string",
"NkViapIncludedVAT": "string",
"NkSppdIncludedVAT": "string",
"N2IncludedVAT": "string",
"N2ViapIncludedVAT": "string",
"N2SppdIncludedVAT": "string",
"D1IncludedVAT": "string",
"D1ViapIncludedVAT": "string",
"D1SppdIncludedVAT": "string",
"D2IncludedVAT": "string",
"D2ViapIncludedVAT": "string",
"D2SppdIncludedVAT": "string",
"N1IncludedVAT": "string",
"N1ViapIncludedVAT": "string",
"N1SppdIncludedVAT": "string",
"VkPayingRecoveredEnergyIncludedVAT": "string",
"DdPayingRecoveredEnergyIncludedVAT": "string",
"NkPayingRecoveredEnergyIncludedVAT": "string",
"N2PayingRecoveredEnergyIncludedVAT": "string",
"D1PayingRecoveredEnergyIncludedVAT": "string",
"D2PayingRecoveredEnergyIncludedVAT": "string",
"N1PayingRecoveredEnergyIncludedVAT": "string",
"VkPayingRecoveredMixedIncludedVAT": "string",
"DdPayingRecoveredMixedIncludedVAT": "string",
"NkPayingRecoveredMixedIncludedVAT": "string",
"N2PayingRecoveredMixedIncludedVAT": "string",
"D1PayingRecoveredMixedIncludedVAT": "string",
"D2PayingRecoveredMixedIncludedVAT": "string",
"N1PayingRecoveredMixedIncludedVAT": "string",
"VkMissingEnergyIncludedVAT": "string",
"VkMissingEnergyViapIncludedVAT": "string",
"VkMissingEnergySppdIncludedVAT": "string",
"DdMissingEnergyIncludedVAT": "string",
"DdMissingEnergyViapIncludedVAT": "string",
"DdMissingEnergySppdIncludedVAT": "string",
"NkMissingEnergyIncludedVAT": "string",
"NkMissingEnergyViapIncludedVAT": "string",
"NkMissingEnergySppdIncludedVAT": "string",

| | | | | | |
|----------------------------|--|--|-------------------|---|----------------------|
| | <pre>"N2MissingEnergyIncludedVAT": "string", "N2MissingEnergyViapIncludedVAT": "string", "N2MissingEnergySppdIncludedVAT": "string", "D1MissingEnergyIncludedVAT": "string", "D1MissingEnergyViapIncludedVAT": "string", "D1MissingEnergySppdIncludedVAT": "string", "D2MissingEnergyIncludedVAT": "string", "D2MissingEnergyViapIncludedVAT": "string", "D2MissingEnergySppdIncludedVAT": "string", "N1MissingEnergyIncludedVAT": "string", "N1MissingEnergyViapIncludedVAT": "string", "N1MissingEnergySppdIncludedVAT": "string", "PowerPlantCapacityIncludedVAT": "string", "PowerPlantCapacityUnit": "string" }]</pre> | | | | |
| JSON error response | <pre>{ "errorMessages": [{ "code": 0, "text": "string" }] }</pre> | | | | |
| Rules | No. | Rule description | Error code | Error message | Attribute |
| | 1. | The order status must be Completed. | 2010 | Invalid report order status. | orderId |
| | 2. | According to the submitted order number: [orderId], the order does not exist. | 2016 | Report order doesn't exist in the system. | orderId |
| | 3. | Invalid method selected or parameter specified incorrectly. According to the submitted order number: [orderId] report type is: [orderType] | 2017 | Invalid method selected for report data or incorrect parameter. | orderId orderType |
| | 4. | No data found based on the search parameters submitted in the POST method. | 2018 | There is no data for the selected search parameters, the response is empty. | orderId |

| | | | | | |
|--|----|---|------|--|-------|
| | 5. | The number of objects in the return list must be less than or equal to 10000. | 2022 | The number of objects on the list has been exceeded. | count |
|--|----|---|------|--|-------|

7.3.9.1 JSON Response structure

The table below describes the structure of the JSON response:

| Attribute | type | obligation | description |
|-----------|------|------------|---|
| - | - | - | Response description are provided in additional documentation . In next document version, all fields description will be provided here. |

7.3.9.2 Error Response Structure

The following table describes the JSON structure in the event of a response error:

| No. | Attribute | type | obligation | description |
|-----|-----------|--------------|------------|----------------|
| 1. | code | number | required | Error code. |
| 2. | text | string(4000) | required | Error message. |

7.3.10 GET/gateway/order/{orderId}/bill-bss-b2b - *will be deployed in 05.18*

| | |
|--------------------|--|
| URI | GET/gateway/order/{orderId}/bill-bss-b2b |
| Description | The method is used to obtain b2b report data. |
| Parameters | <p>URL parameters:</p> <p>orderId – order identification number;</p> <p>first - the index of the report line, which must be the first in the return list (starting from 0). Optional. The default value is 0.</p> <p>count - the number of report rows in the return list. Optional. The default value is 30.</p> |
| Header | After decrypting the supplier authentication key, the supplier ID is used to select the data. |

| | | | |
|----------------------|--|---------------|--|
| JSON request | GET request does not have the BODY part. | | |
| Response | HTTP status code | Reason | Response description |
| | 200 | OK | Request completed successfully |
| | 204 | No content | No data found according to the given parameters. |
| | 400 | Bad Request | Request error. The HTTP response body provides a list of errors in JSON format. |
| | 401 | Unauthorized | An attempt was made to connect to a non-public method that requires authentication, but no user credentials were provided. |
| | 403 | Forbidden | According to the access control policy, the current user does not have access to perform the requested action. |
| | 404 | Not Found | Either there is no API method associated with the request URL path, or the request contains one or more parameters that did not return the data. |
| JSON Response | <pre>[{ "CustomerID": 0, "ClientID": "string", "ClientName": "string", "ClientAddress": "string", "ObjectID": 0, "ObjectNumber": "string", "ObjectName": "string", "ObjectType": "string", "GeneratingCustomer": true, "ObjectAddress": "string", "AgreementType": "string", "AgreementModel": "string", "AgreementFrom": 0, "AgreementTo": 0, "PermittablePowerConsumption": 0, "PermittablePowerGeneration": 0, "InstalledGeneratingPower": 0, </pre> | | |

"InstalledConsumptionPower": 0,
"MetersAmount": 0,
"AutoMetersAmount": 0,
"ReportingPeriod": "2020-09-02",
"BillingPeriod": "2020-09-02",
"SupplyState": "string",
"SupplyStateFrom": "2020-09-02",
"SupplyStateTo": "2020-09-02",
"MetersNumber": "string",
"ReadingsSource": "string",
"ReadingsReceiveDate": "2020-09-02",
"PaymentType": "string",
"DeclarationReferenceType": "string",
"Service": "string",
"ReferenceSubmitDate": "2020-09-02",
"ReadingsSubmitDate": "2020-09-02",
"DeclarationReferenceNumber": 0,
"UnaccountedConsumptionActNumber": 0,
"UnaccountedConsumptionActCreateDate": "2020-09-02",
"UnaccountedConsumptionActFrom": "2020-09-02",
"UnaccountedConsumptionActTo": "2020-09-02",
"ConsumptionConversionActNumber": "string",
"ConsumptionConversionActCreateDate": "2020-09-02",
"ConsumptionConversionActFrom": "2020-09-02",
"ConsumptionConversionActTo": "2020-09-02",
"ConsumptionState": "string",
"ConsumptionStateFrom": "2020-09-02",
"ConsumptionStateTo": "2020-09-02",
"TariffPlan": "string",
"PowerPlantCapacityDateFrom": "2020-09-02",
"EnergyObtainedDateFrom": "2020-09-02",
"PowerPlantCapacityDateTo": "2020-09-02",
"PowerPlantCapacitySource": "string",
"PowerPlantCapacitySourceDateFrom": "2020-09-02",
"PowerPlantCapacitySourceDateTo": "2020-09-02",
"EnergyObtainedDateTo": "2020-09-02",
"EnergyObtainedPowerKw": 0,
"TariffPlanChangeDate": "2020-09-02",
"ConsumptionConversionAct": true,
"UnaccountedAct": true,
"ConversionAct": true,
"OperatorGridElectricityPercent": 0,

"ClientGridElectricityPercent":0,
"GaConsumptionAmount": 0,
"VkConsumptionAmount": 0,
"VkViapConsumptionAmount": 0,
"VkSppdConsumptionAmount": 0,
"VkDiscountConsumptionAmount": 0,
"DdConsumptionAmount": 0,
"DdViapConsumptionAmount": 0,
"DdSppdConsumptionAmount": 0,
"DdDiscountConsumptionAmount": 0,
"NkConsumptionAmount": 0,
"NkViapConsumptionAmount": 0,
"NkSppdConsumptionAmount": 0,
"NkDiscountConsumptionAmount": 0,
"MaConsumptionAmount": 0,
"MaViapConsumptionAmount": 0,
"VdConsumptionAmount": 0,
"VdViapConsumptionAmount": 0,
"SvConsumptionAmount": 0,
"SvViapConsumptionAmount": 0,
"MiConsumptionAmount": 0,
"MiViapConsumptionAmount": 0,
"RvConsumptionAmount": 0,
"RgConsumptionAmount": 0,
"VgConsumptionAmount": 0,
"Reliability1ConsumptionAmount": 0,
"Reliability2ConsumptionAmount": 0,
"Reliability3ConsumptionAmount": 0,
"TechnologicalCostsViapConsumptionAmount": 0,
"TechnologicalCostsConsumptionAmount": 0,
"GeneralInterestConsumptionAmount": 0,
"VkConsumedElectricityConsumptionAmount": 0,
"DdConsumedElectricityConsumptionAmount": 0,
"NkConsumedElectricityConsumptionAmount": 0,
"MaConsumedElectricityConsumptionAmount": 0,
"VdConsumedElectricityConsumptionAmount": 0,
"SvConsumedElectricityConsumptionAmount": 0,
"MiConsumedElectricityConsumptionAmount": 0,
"VkPayingRecoveredEnergyConsumptionAmount": 0,
"DdPayingRecoveredEnergyConsumptionAmount": 0,
"NkPayingRecoveredEnergyConsumptionAmount": 0,
"MaPayingRecoveredEnergyConsumptionAmount": 0,

"VdPayingRecoveredEnergyConsumptionAmount": 0,
"SvPayingRecoveredEnergyConsumptionAmount": 0,
"MiPayingRecoveredEnergyConsumptionAmount": 0,
"VkPayingRecoveredPercentConsumptionAmount": 0,
"DdPayingRecoveredPercentConsumptionAmount": 0,
"NkPayingRecoveredPercentConsumptionAmount": 0,
"MaPayingRecoveredPercentConsumptionAmount": 0,
"VdPayingRecoveredPercentConsumptionAmount": 0,
"SvPayingRecoveredPercentConsumptionAmount": 0,
"MiPayingRecoveredPercentConsumptionAmount": 0,
"VkPayingRecoveredPowerConsumptionAmount": 0,
"DdPayingRecoveredPowerConsumptionAmount": 0,
"NkPayingRecoveredPowerConsumptionAmount": 0,
"MaPayingRecoveredPowerConsumptionAmount": 0,
"VdPayingRecoveredPowerConsumptionAmount": 0,
"SvPayingRecoveredPowerConsumptionAmount": 0,
"MiPayingRecoveredPowerConsumptionAmount": 0,
"VkPayingRecoveredMixedConsumptionAmount": 0,
"DdPayingRecoveredMixedConsumptionAmount": 0,
"NkPayingRecoveredMixedConsumptionAmount": 0,
"MaPayingRecoveredMixedConsumptionAmount": 0,
"VdPayingRecoveredMixedConsumptionAmount": 0,
"SvPayingRecoveredMixedConsumptionAmount": 0,
"MiPayingRecoveredMixedConsumptionAmount": 0,
"VkMissingEnergyConsumptionAmount": 0,
"VkMissingEnergyViapConsumptionAmount": 0,
"VkMissingEnergySppdConsumptionAmount": 0,
"DdMissingEnergyConsumptionAmount": 0,
"DdMissingEnergyViapConsumptionAmount": 0,
"DdMissingEnergySppdConsumptionAmount": 0,
"NkMissingEnergyConsumptionAmount": 0,
"NkMissingEnergyViapConsumptionAmount": 0,
"NkMissingEnergySppdConsumptionAmount": 0,
"MaMissingEnergyConsumptionAmount": 0,
"MaMissingEnergyViapConsumptionAmount": 0,
"VdMissingEnergyConsumptionAmount": 0,
"VdMissingEnergyViapConsumptionAmount": 0,
"SvMissingEnergyConsumptionAmount": 0,
"SvMissingEnergyViapConsumptionAmount": 0,
"MiMissingEnergyConsumptionAmount": 0,
"MiMissingEnergyViapConsumptionAmount": 0,
"VkMissingEnergyDiscountConsumptionAmount": 0,

"DdMissingEnergyDiscountConsumptionAmount": 0,
"NkMissingEnergyDiscountConsumptionAmount": 0,
"GridSuppliedConsumptionAmount": 0,
"AccumulatedBeginningConsumptionAmount": 0,
"AccumulatedEndConsumptionAmount": 0,
"AccumulatedUploadedConsumptionAmount": 0,
"AccumulatedRaisedConsumptionAmount": 0,
"CompensatedConsumptionAmount": 0,
"OldIndependentSupplier": "string",
"PowerPlantCapacityConsumptionAmount": 0,
"EnergyObtainedConsumptionAmount": 0,
"OperatorGridElectricityConsumptionAmount": 0,
"ClientGridElectricityConsumptionAmount": 0,
"PowerPlantCapacityUnit": "string",
"GaUnit": "string",
"VkUnit": "string",
"VkViapUnit": "string",
"VkSppdUnit": "string",
"VkDiscountUnit": "string",
"DdUnit": "string",
"DdViapUnit": "string",
"DdSppdUnit": "string",
"DdDiscountUnit": "string",
"NkUnit": "string",
"NkViapUnit": "string",
"NkSppdUnit": "string",
"NkDiscountUnit": "string",
"MaUnit": "string",
"MaViapUnit": "string",
"VdUnit": "string",
"VdViapUnit": "string",
"SvUnit": "string",
"SvViapUnit": "string",
"MiUnit": "string",
"MiViapUnit": "string",
"RvUnit": "string",
"RgUnit": "string",
"VgUnit": "string",
"Reliability1Unit": "string",
"Reliability2Unit": "string",
"Reliability3Unit": "string",
"TechnologicalCostsViapUnit": "string",

"TechnologicalCostsUnit": "string",
"GeneralInterestUnit": "string",
"VkConsumedElectricityUnit": "string",
"DdConsumedElectricityUnit": "string",
"NkConsumedElectricityUnit": "string",
"MaConsumedElectricityUnit": "string",
"VdConsumedElectricityUnit": "string",
"SvConsumedElectricityUnit": "string",
"MiConsumedElectricityUnit": "string",
"VkPayingRecoveredEnergyUnit": "string",
"DdPayingRecoveredEnergyUnit": "string",
"NkPayingRecoveredEnergyUnit": "string",
"MaPayingRecoveredEnergyUnit": "string",
"VdPayingRecoveredEnergyUnit": "string",
"SvPayingRecoveredEnergyUnit": "string",
"MiPayingRecoveredEnergyUnit": "string",
"VkPayingRecoveredPercentUnit": "string",
"DdPayingRecoveredPercentUnit": "string",
"NkPayingRecoveredPercentUnit": "string",
"MaPayingRecoveredPercentUnit": "string",
"VdPayingRecoveredPercentUnit": "string",
"SvPayingRecoveredPercentUnit": "string",
"MiPayingRecoveredPercentUnit": "string",
"VkPayingRecoveredPowerUnit": "string",
"DdPayingRecoveredPowerUnit": "string",
"NkPayingRecoveredPowerUnit": "string",
"MaPayingRecoveredPowerUnit": "string",
"VdPayingRecoveredPowerUnit": "string",
"SvPayingRecoveredPowerUnit": "string",
"MiPayingRecoveredPowerUnit": "string",
"VkPayingRecoveredMixedUnit": "string",
"DdPayingRecoveredMixedUnit": "string",
"NkPayingRecoveredMixedUnit": "string",
"MaPayingRecoveredMixedUnit": "string",
"VdPayingRecoveredMixedUnit": "string",
"SvPayingRecoveredMixedUnit": "string",
"MiPayingRecoveredMixedUnit": "string",
"VkMissingEnergyUnit": "string",
"VkMissingEnergyViapUnit": "string",
"VkMissingEnergySppdUnit": "string",
"DdMissingEnergyUnit": "string",
"DdMissingEnergyViapUnit": "string",

"DdMissingEnergySppdUnit": "string",
"NkMissingEnergyUnit": "string",
"NkMissingEnergyViapUnit": "string",
"NkMissingEnergySppdUnit": "string",
"MaMissingEnergyUnit": "string",
"MaMissingEnergyViapUnit": "string",
"VdMissingEnergyUnit": "string",
"VdMissingEnergyViapUnit": "string",
"SvMissingEnergyUnit": "string",
"SvMissingEnergyViapUnit": "string",
"MiMissingEnergyUnit": "string",
"MiMissingEnergyViapUnit": "string",
"VkMissingEnergyDiscountUnit": "string",
"DdMissingEnergyDiscountUnit": "string",
"NkMissingEnergyDiscountUnit": "string",
"VkReadingsFrom": 0,
"DdReadingsFrom": 0,
"NkReadingsFrom": 0,
"MaReadingsFrom": 0,
"VdReadingsFrom": 0,
"SvReadingsFrom": 0,
"MiReadingsFrom": 0,
"RvReadingsFrom": 0,
"RgReadingsFrom": 0,
"VkConsumedElectricityReadingsFrom": 0,
"DdConsumedElectricityReadingsFrom": 0,
"NkConsumedElectricityReadingsFrom": 0,
"MaConsumedElectricityReadingsFrom": 0,
"VdConsumedElectricityReadingsFrom": 0,
"SvConsumedElectricityReadingsFrom": 0,
"MiConsumedElectricityReadingsFrom": 0,
"GridSuppliedReadingsFrom": 0,
"VkReadingsTo": 0,
"DdReadingsTo": 0,
"NkReadingsTo": 0,
"MaReadingsTo": 0,
"VdReadingsTo": 0,
"SvReadingsTo": 0,
"MiReadingsTo": 0,
"RvReadingsTo": 0,
"RgReadingsTo": 0,
"VkConsumedElectricityReadingsTo": 0,

"DdConsumedElectricityReadingsTo": 0,
"NkConsumedElectricityReadingsTo": 0,
"MaConsumedElectricityReadingsTo": 0,
"VdConsumedElectricityReadingsTo": 0,
"SvConsumedElectricityReadingsTo": 0,
"MiConsumedElectricityReadingsTo": 0,
"GridSuppliedReadingsTo": 0,
"GaPriceEur": 0,
"VkPriceEur": 0,
"VkViapPriceEur": 0,
"VkSppdPriceEur": 0,
"VkDiscountPriceEur": 0,
"DdPriceEur": 0,
"DdViapPriceEur": 0,
"DdSppdPriceEur": 0,
"DdDiscountPriceEur": 0,
"NkPriceEur": 0,
"NkViapPriceEur": 0,
"NkSppdPriceEur": 0,
"NkDiscountPriceEur": 0,
"MaPriceEur": 0,
"MaViapPriceEur": 0,
"VdPriceEur": 0,
"VdViapPriceEur": 0,
"SvPriceEur": 0,
"SvViapPriceEur": 0,
"MiPriceEur": 0,
"MiViapPriceEur": 0,
"RvPriceEur": 0,
"RgPriceEur": 0,
"VgPriceEur": 0,
"Reliability1PriceEur": 0,
"Reliability2PriceEur": 0,
"Reliability3PriceEur": 0,
"TechnologicalCostsViapPriceEur": 0,
"TechnologicalCostsPriceEur": 0,
"GeneralInterestPriceEur": 0,
"VkPayingRecoveredEnergyPriceEur": 0,
"DdPayingRecoveredEnergyPriceEur": 0,
"NkPayingRecoveredEnergyPriceEur": 0,
"MaPayingRecoveredEnergyPriceEur": 0,
"VdPayingRecoveredEnergyPriceEur": 0,

"SvPayingRecoveredEnergyPriceEur": 0,
"MiPayingRecoveredEnergyPriceEur": 0,
"VkPayingRecoveredMixedPriceEur": 0,
"DdPayingRecoveredMixedPriceEur": 0,
"NkPayingRecoveredMixedPriceEur": 0,
"MaPayingRecoveredMixedPriceEur": 0,
"VdPayingRecoveredMixedPriceEur": 0,
"SvPayingRecoveredMixedPriceEur": 0,
"MiPayingRecoveredMixedPriceEur": 0,
"VkMissingEnergyPriceEur": 0,
"VkMissingEnergyViapPriceEur": 0,
"VkMissingEnergySppdPriceEur": 0,
"DdMissingEnergyPriceEur": 0,
"DdMissingEnergyViapPriceEur": 0,
"DdMissingEnergySppdPriceEur": 0,
"NkMissingEnergyPriceEur": 0,
"NkMissingEnergyViapPriceEur": 0,
"NkMissingEnergySppdPriceEur": 0,
"MaMissingEnergyPriceEur": 0,
"MaMissingEnergyViapPriceEur": 0,
"VdMissingEnergyPriceEur": 0,
"VdMissingEnergyViapPriceEur": 0,
"SvMissingEnergyPriceEur": 0,
"SvMissingEnergyViapPriceEur": 0,
"MiMissingEnergyPriceEur": 0,
"MiMissingEnergyViapPriceEur": 0,
"VkMissingEnergyDiscountPriceEur": 0,
"DdMissingEnergyDiscountPriceEur": 0,
"NkMissingEnergyDiscountPriceEur": 0,
"PowerPlantCapacityPriceEur": 0,
"GaDiscount": 0,
"VkDiscount": 0,
"VkViapDiscount": 0,
"VkSppdDiscount": 0,
"VkDiscountDiscount": 0,
"DdDiscount": 0,
"DdViapDiscount": 0,
"DdSppdDiscount": 0,
"DdDiscountDiscount": 0,
"NkDiscount": 0,
"NkViapDiscount": 0,
"NkSppdDiscount": 0,

"NkDiscountDiscount": 0,
"MaDiscount": 0,
"MaViapDiscount": 0,
"VdDiscount": 0,
"VdViapDiscount": 0,
"SvDiscount": 0,
"SvViapDiscount": 0,
"MiDiscount": 0,
"MiViapDiscount": 0,
"RvDiscount": 0,
"RgDiscount": 0,
"VgDiscount": 0,
"Reliability1Discount": 0,
"Reliability2Discount": 0,
"Reliability3Discount": 0,
"TechnologicalCostsViapDiscount": 0,
"TechnologicalCostsDiscount": 0,
"GeneralInterestDiscount": 0,
"VkPayingRecoveredEnergyDiscount": 0,
"VkPayingRecoveredMixedDiscount": 0,
"VkMissingEnergyDiscount": 0,
"VkMissingEnergyViapDiscount": 0,
"VkMissingEnergySppdDiscount": 0,
"VkMissingEnergyDiscountDiscount": 0,
"GaAmountNoVAT": 0,
"VkAmountNoVAT": 0,
"VkViapAmountNoVAT": 0,
"VkSppdAmountNoVAT": 0,
"VkDiscountAmountNoVAT": 0,
"DdAmountNoVAT": 0,
"DdViapAmountNoVAT": 0,
"DdSppdAmountNoVAT": 0,
"DdDiscountAmountNoVAT": 0,
"NkAmountNoVAT": 0,
"NkViapAmountNoVAT": 0,
"NkSppdAmountNoVAT": 0,
"NkDiscountAmountNoVAT": 0,
"MaAmountNoVAT": 0,
"MaViapAmountNoVAT": 0,
"VdAmountNoVAT": 0,
"VdViapAmountNoVAT": 0,
"SvAmountNoVAT": 0,

"SvViapAmountNoVAT": 0,
"MiAmountNoVAT": 0,
"MiViapAmountNoVAT": 0,
"RvAmountNoVAT": 0,
"RgAmountNoVAT": 0,
"VgAmountNoVAT": 0,
"Reliability1AmountNoVAT": 0,
"Reliability2AmountNoVAT": 0,
"Reliability3AmountNoVAT": 0,
"TechnologicalCostsViapAmountNoVAT": 0,
"TechnologicalCostsAmountNoVAT": 0,
"GeneralInterestAmountNoVAT": 0,
"VkPayingRecoveredEnergyAmountNoVAT": 0,
"DdPayingRecoveredEnergyAmountNoVAT": 0,
"NkPayingRecoveredEnergyAmountNoVAT": 0,
"MaPayingRecoveredEnergyAmountNoVAT": 0,
"VdPayingRecoveredEnergyAmountNoVAT": 0,
"SvPayingRecoveredEnergyAmountNoVAT": 0,
"MiPayingRecoveredEnergyAmountNoVAT": 0,
"VkPayingRecoveredMixedAmountNoVAT": 0,
"DdPayingRecoveredMixedAmountNoVAT": 0,
"NkPayingRecoveredMixedAmountNoVAT": 0,
"MaPayingRecoveredMixedAmountNoVAT": 0,
"VdPayingRecoveredMixedAmountNoVAT": 0,
"SvPayingRecoveredMixedAmountNoVAT": 0,
"MiPayingRecoveredMixedAmountNoVAT": 0,
"VkMissingEnergyAmountNoVAT": 0,
"VkMissingEnergyViapAmountNoVAT": 0,
"VkMissingEnergySppdAmountNoVAT": 0,
"DdMissingEnergyAmountNoVAT": 0,
"DdMissingEnergyViapAmountNoVAT": 0,
"DdMissingEnergySppdAmountNoVAT": 0,
"NkMissingEnergyAmountNoVAT": 0,
"NkMissingEnergyViapAmountNoVAT": 0,
"NkMissingEnergySppdAmountNoVAT": 0,
"MaMissingEnergyAmountNoVAT": 0,
"MaMissingEnergyViapAmountNoVAT": 0,
"VdMissingEnergyAmountNoVAT": 0,
"VdMissingEnergyViapAmountNoVAT": 0,
"SvMissingEnergyAmountNoVAT": 0,
"SvMissingEnergyViapAmountNoVAT": 0,
"MiMissingEnergyAmountNoVAT": 0,

| | | | | | |
|----------------------------|---|--|-------------------|---|----------------------|
| | <pre>"MiMissingEnergyViapAmountNoVAT": 0, "VkMissingEnergyDiscountAmountNoVAT": 0, "DdMissingEnergyDiscountAmountNoVAT": 0, "NkMissingEnergyDiscountAmountNoVAT": 0, "PowerPlantCapacityAmountNoVAT": 0, "PermanentHomePlusAmountNoVAT": 0, "PermanentHomeAmountNoVAT": 0 }]</pre> | | | | |
| JSON error response | <pre>{ "errorMessages": [{ "code": 0, "text": "string" }] }</pre> | | | | |
| Rules | No. | Rule description | Error code | Error message | Attribute |
| | 1. | The order status must be Completed. | 2010 | Invalid report order status. | orderId |
| | 2. | According to the submitted order number: [orderId], the order does not exist. | 2016 | Report order doesn't exist in the system. | orderId |
| | 3. | Invalid method selected or parameter specified incorrectly. According to the submitted order number: [orderId] report type is: [orderType] | 2017 | Invalid method selected for report data or incorrect parameter. | orderId orderType |
| | 4. | No data found based on the search parameters submitted in the POST method. | 2018 | There is no data for the selected search parameters, the response is empty. | orderId |
| | 5. | The number of objects in the return list must be less than or equal to 10000. | 2022 | The number of objects on the list has been exceeded. | count |

7.3.10.1 JSON Response structure

The table below describes the structure of the JSON response:

| Attribute | type | obligation | description |
|-----------|------|------------|-------------|
|-----------|------|------------|-------------|

| | | | |
|---|---|---|--|
| - | - | - | Response description are provided in https://datahub.eso.lt/dokumentacija . In next document version, all fields description will be provided here. |
|---|---|---|--|

7.3.10.2 Error Response Structure

The following table describes the JSON structure in the event of a response error:

| No. | Attribute | type | obligation | description |
|-----|-----------|--------------|------------|----------------|
| 1. | code | number | required | Error code. |
| 2. | text | string(4000) | required | Error message. |

7.3.11 GET/gateway/order/{orderId}/count

| | | | |
|---------------------|---|---------------|--|
| URI | GET/gateway/order/{orderId}/count | | |
| Description | Method which will return count (number), how many items Supplier will get in ordered report (reports could have more than 1 item, so it is List). It should be used when supplier need to split data in few portions. This response should be used in reports' GET methods request, where Supplier can provide method parameters information. | | |
| Parameters | URL parameters: orderId – order identification number | | |
| Header | After decrypting the supplier authentication key, the supplier ID is used to select the data. | | |
| JSON request | GET request does not have the BODY part. | | |
| Response | HTTP status code | Reason | Response description |
| | 200 | OK | Request completed successfully |
| | 204 | No content | No data found according to the given parameters. |
| | 400 | Bad Request | Request error. The HTTP response body provides a list of errors in JSON format. |
| | 401 | Unauthorized | An attempt was made to connect to a non-public method that requires authentication, but no user credentials were provided. |

| | | | | | |
|----------------------------|---|--|--|---|----------------------|
| | 403 | Forbidden | According to the access control policy, the current user does not have access to perform the requested action. | | |
| | 404 | Not Found | Either there is no API method associated with the request URL path, or the request contains one or more parameters that did not return the data. | | |
| | 423 | Locked | The source or destination resource of a method is locked. This response SHOULD contain an appropriate precondition or postcondition code, such as 'lock-token-submitted' or 'no-conflicting-lock'. | | |
| JSON Response | <pre>{ "count": "number" }</pre> | | | | |
| JSON error response | <pre>{ "errorMessages": [{ "code": 0, "text": "string" }] }</pre> | | | | |
| Rules | No. | Rule description | Error code | Error message | Attribute |
| | 1. | The order status must be Completed. | 2010 | Invalid report order status. | orderId |
| | 2. | According to the submitted order number: [orderId], the order does not exist. | 2016 | Report order doesn't exist in the system. | orderId |
| | 3. | Invalid method selected or parameter specified incorrectly. According to the submitted order number: [orderId] report type is: [orderType] | 2017 | Invalid method selected for report data or incorrect parameter. | orderId orderType |
| | 4. | No data found based on the search parameters submitted in the POST method. | 2018 | There is no data for the selected search parameters, the response is empty. | orderId |

7.3.11.1 JSON Request structure

The table below describes the structure of the JSON request:

| Attribute | type | obligation | description |
|-----------|------|------------|-------------|
| | | | |

7.3.11.2 JSON Response structure

The table below describes the structure of the JSON response:

| No. | Attribute | type | obligation | description |
|-----|-----------|------------|------------|--|
| 1. | count | Number(10) | required | Number of rows, objects, accounts, depending on the selected report. |

7.3.11.3 Error Response Structure

The following table describes the JSON structure in the event of a response error:

| No. | Attribute | type | obligation | description |
|-----|-----------|--------------|------------|----------------|
| 1. | code | number | required | Error code. |
| 2. | text | string(4000) | required | Error message. |

7.3.12 POST/gateway/order/data-hr-15min-mtr-lvl-acr

| | |
|--------------------|---|
| URI | POST/gateway/order/data-hr-15min-mtr-lvl-acr |
| Description | The method is designed for ordering data for automated quantities at the counter level according to the rights granted. |
| Parameters | URL: The JSON data is contained in the HTTP request (BODY) (see <i>JSON structure, below</i>). |
| Header | After decrypting the supplier authentication key, the supplier ID is used to select the data. |

| | | | | | |
|----------------------------|--|-------------------------|--|----------------------|-------------------|
| JSON request | <pre>{ "dateFrom": "date", "dateTo": "date", "consumptionCategories":[string, string], "objectNumbers":[string, string], "interval":"string" }</pre> | | | | |
| Response HTTP code | HTTP status code | Reason | Description | | |
| | 201 | Created | The request has been successfully completed. | | |
| | 400 | Bad Request | Request error. The HTTP response body provides a list of errors in JSON format. (<i>Error response of the JSON structure below</i>). | | |
| | 401 | Unauthorized | An attempt was made to connect to a non-public method that requires authentication, but no user credentials were provided. | | |
| | 403 | Forbidden | According to the access control policy, the current user does not have access to perform the requested action. | | |
| | 404 | Not Found | Either there is no API method associated with the request URL path, or the request contains one or more parameters that did not return the data. | | |
| JSON response | <pre>{ "orderId": "number" }</pre> | | | | |
| JSON error response | <pre>{ "errorMessages": [{ "code": 0, "text": "string" }] }</pre> | | | | |
| Rules | No. | Rule description | Error code | Error message | Attributes |

| | | | | |
|-----|---|------|--|---------------------------------------|
| 1. | If an attribute has defined possible values, the value index can be specified by specifying the value of the attribute in the request. Indices of all possible values start from 0. | - | - | All attributes with specified values. |
| 2. | Date format is incorrect. | - | - | dateFrom dateTo |
| 3. | The date from cannot be later than the date to, but can be equal. | 1002 | Date from cannot be later than date to. | dateFrom dateTo |
| 4. | The date from and date to cannot be later than the current date, but can be equal. | 1008 | Date from and date to cannot be later than the current date. | dateFrom |
| 5. | Object meter must be automated. | 2007 | The submitted object number: [objectNumber (if there is more than one object, objects must be separated by the semicolon)], was not found or the meter of object is not automated. | objectNumbers |
| 6. | Data cannot be older than 36 months old. | 2012 | Date from date cannot be older than 36 months old. | dateFrom |
| 7. | Report can be ordered maximum for 12 months. | 2013 | The report can only be ordered for 12 months or less. | dateFrom dateTo |
| 8. | The period date from and date to must be less than date from configurable parameter. | 2015 | Data is not currently available for the selected reporting period. | dateFrom dateTo |
| 9. | The object must have a valid access right. | 2020 | Object [objectNumber (if there is more than one object, objects must be separated by the semicolon)] does not have a access right or access right is expired. | objectNumbers |
| 10. | A maximum of 500 objects can be submitted in a report order | 2021 | A maximum of 500 objects can be submitted in a report order | objectNumbers |

7.3.12.1 JSON Request structure

The table below describes the structure of the JSON request:

| No. | Attribute | type | obligation | description |
|-----|---------------------|------------|------------|---|
| 1. | dateFrom | Date | required | The beginning of the reporting period: <ul style="list-style-type: none"> The format: YYYY-MM-DD; The reporting period start date is the first day of the month. |
| 2. | dateTo | Date | required | The end of the reporting period: <ul style="list-style-type: none"> The format: YYYY-MM-DD; The reporting period end date is the last day of the month. |
| 3. | consumptionCategory | String(20) | required | The consumption category. Possible meanings: <ul style="list-style-type: none"> P+; P-; Q+; Q-; |
| 4. | objectNumbers | String | required | Object number. |
| 5. | interval | String | required | Consumption interval. Possible meanings: <ul style="list-style-type: none"> - HOUR - QUARTER |

7.3.12.2 JSON Response structure

The table below describes the structure of the JSON response:

| No. | Attribute | type | obligation | description |
|-----|-----------|---------|------------|--|
| 1. | orderId | Integer | required | The report ordering primary surrogate key. |

7.3.12.3 Error Response Structure

The following table describes the JSON structure in the event of a response error:

| No. | Attribute | type | obligation | description |
|-----|-----------|--------------|------------|----------------|
| 1. | code | number | required | Error code. |
| 2. | text | string(4000) | required | Error message. |

7.3.13 POST/gateway/order/data-hr-15min-obj-lvl-acr

| | | | |
|---------------------------|---|---------------|--|
| URI | POST/gateway/order/data-hr-15min-obj-lvl-acr | | |
| Description | The method is designed for ordering data for automated quantities at the object level according to the rights granted. | | |
| Parameters | URL: The JSON data is contained in the HTTP request (BODY) (<i>see JSON structure, below</i>). | | |
| Header | After decrypting the supplier authentication key, the supplier ID is used to select the data. | | |
| JSON request | <pre>{ "dateFrom": "date", "dateTo": "date", "consumptionCategories": [string, string], "objectNumbers": [string, string], "interval": "string" }</pre> | | |
| Response HTTP code | HTTP status code | Reason | Description |
| | 201 | Created | The request has been successfully completed. |
| | 400 | Bad Request | Request error. The HTTP response body provides a list of errors in JSON format. (<i>Error response of the JSON structure below</i>). |
| | 401 | Unauthorized | An attempt was made to connect to a non-public method that requires authentication, but no user credentials were provided. |
| | 403 | Forbidden | According to the access control policy, the current user does not have access to perform the requested action. |
| | 404 | Not Found | Either there is no API method associated with the request URL path, or the request contains one or more parameters that did not return the data. |
| JSON response | <pre>{ "orderId": "number" }</pre> | | |

| | | | | | |
|----------------------------|---|---|-------------------|--|---------------------------------------|
| | } | | | | |
| JSON error response | <pre>{ "errorMessages": [{ "code": 0, "text": "string" }] }</pre> | | | | |
| Rules | No. | Rule description | Error code | Error message | Attributes |
| | 1. | If an attribute has defined possible values, the value index can be specified by specifying the value of the attribute in the request. Indices of all possible values start from 0. | - | - | All attributes with specified values. |
| | 2. | Date format is incorrect. | - | - | dateFrom dateTo |
| | 3. | The date from cannot be later than the date to, but can be equal. | 1002 | Date from cannot be later than date to. | dateFrom dateTo |
| | 4. | The date from and date to cannot be later than the current date, but can be equal. | 1008 | Date from and date to cannot be later than the current date. | dateFrom |
| | 5. | Object meter must be automated. | 2007 | The submitted object number: [objectNumber (if there is more than one object, objects must be separated by the semicolon)], was not found or the meter of object is not automated. | objectNumbers |
| | 6. | Data cannot be older than 36 months old. | 2012 | Date from date cannot be older than 36 months old. | dateFrom |
| | 7. | Report can be ordered maximum for 12 months. | 2013 | The report can only be ordered for 12 months or less. | dateFrom dateTo |

| | | | | | |
|--|-----|--|------|---|--------------------|
| | 8. | The period date from and date to must be less than date from configurable parameter. | 2015 | Data is not currently available for the selected reporting period. | dateFrom dateTo |
| | 9. | The object must have a valid access right. | 2020 | Object [objectNumber (if there is more than one object, objects must be separated by the semicolon)] does not have a access right or access right is expired. | objectNumbers |
| | 10. | A maximum of 500 objects can be submitted in a report order | 2021 | A maximum of 500 objects can be submitted in a report order | objectNumbers |

7.3.13.1 JSON Request structure

The table below describes the structure of the JSON request:

| No. | Attribute | type | obligation | description |
|-----|---------------------|------------|------------|---|
| 1. | dateFrom | Date | required | The beginning of the reporting period: <ul style="list-style-type: none"> The format: YYYY-MM-DD; The reporting period start date is the first day of the month. |
| 2. | dateTo | Date | required | The end of the reporting period: <ul style="list-style-type: none"> The format: YYYY-MM-DD; The reporting period end date is the last day of the month. |
| 3. | consumptionCategory | String(20) | required | The consumption category. Possible meanings: <ul style="list-style-type: none"> P+; P-; Q+; Q-; |
| 4. | objectNumbers | String | required | Object number. |
| 5. | interval | String | required | Consumption interval. Possible meanings: <ul style="list-style-type: none"> - HOUR - QUARTER |

7.3.13.2 JSON Response structure

The table below describes the structure of the JSON response:

| No. | Attribute | type | obligation | description |
|-----|-----------|---------|------------|--|
| 1. | orderId | Integer | required | The report ordering primary surrogate key. |

7.3.13.3 Error Response Structure

The following table describes the JSON structure in the event of a response error:

| No. | Attribute | type | obligation | description |
|-----|-----------|--------------|------------|----------------|
| 1. | code | number | required | Error code. |
| 2. | text | string(4000) | required | Error message. |

7.3.14 POST/gateway/order/data-sum-obj-lvl-acr

| | | | |
|---------------------------|--|---------------|--|
| URI | POST/gateway/order/data-sum-obj-lvl-acr | | |
| Description | The method is for order a report of total quantities according to the granted rights. | | |
| Parameters | URL: The JSON data is contained in the HTTP request (BODY) (<i>see JSON structure, below</i>). | | |
| Header | After decrypting the supplier authentication key, the supplier ID is used to select the data. | | |
| JSON request | <pre>{ "dateFrom": "date", "dateTo": "date", "objectNumbers": ["string"] }</pre> | | |
| Response HTTP code | HTTP status code | Reason | Description |
| | 201 | Created | The request has been successfully completed. |
| | 400 | Bad Request | Request error. The HTTP response body provides a list of errors in JSON format. (<i>Error response of the JSON structure below</i>). |

| | | |
|-----|--------------|--|
| 401 | Unauthorized | An attempt was made to connect to a non-public method that requires authentication, but no user credentials were provided. |
| 403 | Forbidden | According to the access control policy, the current user does not have access to perform the requested action. |
| 404 | Not Found | Either there is no API method associated with the request URL path, or the request contains one or more parameters that did not return the data. |

| | |
|----------------------------|---|
| JSON response | <pre>{ "orderId": "number" }</pre> |
| JSON error response | <pre>{ "errorMessages": [{ "code": 0, "text": "string" }] }</pre> |

| Rules | No. | Rule description | Error code | Error message | Attributes |
|--------------|------------|--|-------------------|--|--------------------|
| | 1. | Date format is incorrect. | - | - | dateFrom dateTo |
| | 2. | The date from cannot be later than the date to, but can be equal. | 1002 | Date from cannot be later than date to. | dateFrom dateTo |
| | 3. | Data cannot be older than 36 months old. | 2012 | Date from date cannot be older than 36 months old. | dateFrom |
| | 5. | The period date from and date to must be less than date from configurable parameter. | 2015 | Data is not currently available for the selected reporting period. | dateFrom dateTo |
| | 6. | The object must have a valid access right. | 2020 | Object [objectNumbers (if there is more than one object, objects must be separated by the semicolon)] does not have a access right or access right is expired. | objectNumbers |

| | | | | | |
|--|----|--|------|---|--------------------|
| | 7. | A maximum of 500 objects can be submitted in a report order. | 2021 | A maximum of 500 objects can be submitted in a report order. | objectNumbers |
| | 8. | The date from and date to cannot be later than the current date, but can be equal. | 1008 | Date from and date to cannot be later than the current date. | dateFrom dateTo |
| | 9. | dateFrom - must be the first day of the month; dateTo - must be the last day of the month, unless dateTo coincides with the current month, then must be currentDate | 2009 | Date from must be the first day of the month. Date to must be the last day of the month, unless date to coincides with the current day. | dateFrom dateTo |

7.3.14.1 JSON Request structure

The table below describes the structure of the JSON request:

| No. | Attribute | type | obligation | description |
|-----|---------------|--------|------------|---|
| 1. | dateFrom | Date | required | The beginning of the reporting period: <ul style="list-style-type: none"> The format: YYYY-MM-DD; The reporting period start date is the first day of the month. |
| 2. | dateTo | Date | required | The end of the reporting period: <ul style="list-style-type: none"> The format: YYYY-MM-DD; The reporting period end date is the last day of the month. |
| 4. | objectNumbers | String | required | Object numbers. |

7.3.14.2 JSON Response structure

The table below describes the structure of the JSON response:

| No. | Attribute | type | obligation | description |
|-----|-----------|---------|------------|--|
| 1. | orderId | Integer | required | The report ordering primary surrogate key. |

7.3.14.3 Error Response Structure

The following table describes the JSON structure in the event of a response error:

| No. | Attribute | type | obligation | description |
|-----|-----------|--------------|------------|----------------|
| 1. | code | number | required | Error code. |
| 2. | text | string(4000) | required | Error message. |

7.3.15 POST/gateway/order/report-obj-acr

| | | | |
|-------------------------------|--|---------------|--|
| URI | POST /gateway/order/report-obj-acr | | |
| Description | The method is for order a report of objects according to the granted rights. | | |
| Parameters | URL: The JSON data is contained in the HTTP request (BODY) (<i>see JSON structure, below</i>). | | |
| Header | After decrypting the supplier authentication key, the supplier ID is used to select the data. | | |
| JSON request | <pre>{ "objectNumbers":["string"] }</pre> | | |
| Response HTTP code | HTTP status code | Reason | Description |
| | 201 | Created | The request has been successfully completed. |
| | 400 | Bad Request | Request error. The HTTP response body provides a list of errors in JSON format. (<i>Error response of the JSON structure below</i>). |
| | 401 | Unauthorized | An attempt was made to connect to a non-public method that requires authentication, but no user credentials were provided. |
| | 403 | Forbidden | According to the access control policy, the current user does not have access to perform the requested action. |
| | 404 | Not Found | Either there is no API method associated with the request URL path, or the request contains one or more parameters that did not return the data. |

| | | | | | |
|----------------------------|---|--|-------------------|--|-------------------|
| JSON response | <pre>{ "orderId": "number" }</pre> | | | | |
| JSON error response | <pre>{ "errorMessages": [{ "code": 0, "text": "string" }] }</pre> | | | | |
| Rules | No. | Rule description | Error code | Error message | Attributes |
| | 1. | The object must have a valid access right. | 2020 | Object [objectNumbers (if there is more than one object, objects must be separated by the semicolon)] does not have a access right or access right is expired. | objectNumbers |
| | 2. | A maximum of 500 objects can be submitted in a report order. | 2021 | A maximum of 500 objects can be submitted in a report order. | objectNumbers |

7.3.15.1 JSON Request structure

The table below describes the structure of the JSON request:

| No. | Attribute | type | obligation | description |
|-----|---------------|--------|------------|-----------------|
| 1. | objectNumbers | String | required | Object numbers. |

7.3.15.2 JSON Response structure

The table below describes the structure of the JSON response:

| No. | Attribute | type | obligation | description |
|-----|-----------|---------|------------|--|
| 1. | orderId | Integer | required | The report ordering primary surrogate key. |

7.3.15.3 Error Response Structure

The following table describes the JSON structure in the event of a response error:

| No. | Attribute | type | obligation | description |
|-----|-----------|--------------|------------|----------------|
| 1. | code | number | required | Error code. |
| 2. | text | string(4000) | required | Error message. |

7.3.16 GET /gateway/order/{orderId}/data-hr-15min-obj-lvl-acr

| | | | |
|---------------------------|--|--|--|
| URI | GET /gateway/order/{orderId}/data-hr-15min-obj-lvl-acr | | |
| Description | The method for receive the order report "Automated quantities at the object level according to the granted rights". | | |
| Parameters | <p>URL parameters:</p> <p>orderId – order identification number</p> <p>first - the index of the object, which must be the first in the return list (starting from 0). Optional. The default value is 0.</p> <p>count - the number of objects in the return list. Optional. The default value is 10000. If no count value is given, the default value count will be 10000.</p> | | |
| Header | After decrypting the supplier authentication key, the supplier ID is used to select the data. | | |
| JSON request | | | |
| Response HTTP code | HTTP status code | Reason | Description |
| | 200 | OK | Request completed successfully. |
| | 204 | No content | No data found according to the given parameters. |
| | 400 | Bad Request | Request error. The HTTP response body provides a list of errors in JSON format. (<i>Error response of the JSON structure below</i>). |
| 401 | Unauthorized | An attempt was made to connect to a non-public method that requires authentication, but no user credentials were provided. | |

| | | | |
|----------------------|--|-----------|--|
| | 403 | Forbidden | According to the access control policy, the current user does not have access to perform the requested action. |
| | 404 | Not Found | Either there is no API method associated with the request URL path, or the request contains one or more parameters that did not return the data. |
| JSON response | <pre> { "personCode": "string", "personName": "string", "personSurname": "string", "objectId": number, "objectNumber": "string", "consumptionCategories": [{ "consumptionCategory": "string", "consumptions": [{ "consumptionTime": "datetime", "amount": number, "valueType": "string" }] }] } </pre> | | |

| | | | | | |
|----------------------------|---|--|-------------------|---|----------------------|
| | } | | | | |
| JSON error response | <pre>{ "errorMessages": [{ "code": 0, "text": "string" }] }</pre> | | | | |
| Rules | No. | Rule description | Error code | Error message | Attributes |
| | 1. | The order status must be Completed. | 2010 | Invalid report order status. | orderId |
| | 2. | According to the submitted order number: [orderId], the order does not exist. | 2016 | Report order doesn't exist in the system. | orderId |
| | 3. | Invalid method selected or parameter specified incorrectly. According to the submitted order number: [orderId] report type is: [orderType] | 2017 | Invalid method selected for report data or incorrect parameter. | orderId orderType |
| | 4. | No data found based on the search parameters submitted in the POST method. | 2018 | There is no data for the selected search parameters, the response is empty. | orderId |
| | 5. | The number of objects in the return list must be less than or equal to 10000. | 2022 | The number of objects on the list has been exceeded. | count |

7.3.16.1 JSON Request structure

The table below describes the structure of the JSON request:

| No. | Attribute | type | obligation | description |
|-----|-----------|------|------------|-------------|
| | | | | |

7.3.16.2 JSON Response structure

The table below describes the structure of the JSON response:

| No. | Attribute | type | obligation | description |
|--------------------------|---------------------|-------------|------------|---|
| 1. | personCode | String(20) | required | Person code. |
| 2. | personName | String(200) | required | Person name / company name. |
| 3. | personSurname | String(50) | required | Person surname. |
| 4. | objectId | Integer | required | Object ID. |
| 5. | objectNumber | String(20) | required | Object number. |
| consumptionCategories:[] | | | | |
| 8. | consumptionCategory | String(2) | required | Consumption category. Possible meanings: <ul style="list-style-type: none"> • P+; • P-; • Q+; • Q-. |
| consumptions:[] | | | | |
| | consumptionTime | datetime | required | Consumption time. Example of consumptionTime format: 2022-06-07T00:00:00+02:00 2022-06-07T00:00:00+03:00 |
| 9. | amount | number | required | Consumption amount. |
| 10. | valueType | String(3) | required | Consumption value type. Possible meanings: <ul style="list-style-type: none"> • EST – estimated; • VAL – validated. |

7.3.16.3 Error Response Structure

The following table describes the JSON structure in the event of a response error:

| No. | Attribute | type | obligation | description |
|-----|-----------|--------------|------------|----------------|
| 1. | code | number | required | Error code. |
| 2. | text | string(4000) | required | Error message. |

7.3.17 GET /gateway/order/{orderId}/data-hr-15min-mtr-lvl-acr

| | | | |
|---------------------------|---|---------------|--|
| URI | GET /gateway/order/{orderId}/data-hr-15min-mtr-lvl-acr | | |
| Description | The method for receive the order report " Automated quantities at the meter level based on granted rights". | | |
| Parameters | <p>URL parameters:</p> <p>orderId – order identification number</p> <p>first - the index of the object, which must be the first in the return list (starting from 0). Optional. The default value is 0.</p> <p>count - the number of objects in the return list. Optional. The default value is 10000. If no count value is given, the default value count will be 10000.</p> | | |
| Header | After decrypting the supplier authentication key, the supplier ID is used to select the data. | | |
| JSON request | | | |
| Response HTTP code | HTTP status code | Reason | Description |
| | 200 | OK | Request completed successfully. |
| | 204 | No content | No data found according to the given parameters. |
| | 400 | Bad Request | Request error. The HTTP response body provides a list of errors in JSON format. (<i>Error response of the JSON structure below</i>). |
| | 401 | Unauthorized | An attempt was made to connect to a non-public method that requires authentication, but no user credentials were provided. |
| | 403 | Forbidden | According to the access control policy, the current user does not have access to perform the requested action. |
| | 404 | Not Found | Either there is no API method associated with the request URL path, or the request contains one or more parameters that did not return the data. |
| JSON response | [{ | | |

```
"personCode":"string",
"personName":"string",
"personSurname":"string",
"objectId":number,
"objectNumber":"string",
"meters":[
  {
    "meterNumber":"string",
    "categories":[
      {
        "consumptionCategory":"string",
        "consumptions":[
          {
            "consumptionTime":"datetime",
            "amount":number,
            "valueType":"string"
          }
        ]
      }
    ]
  }
]
```

| | | | | | |
|----------------------------|---|--|-------------------|---|----------------------|
| JSON error response | <pre> { "errorMessages": [{ "code": 0, "text": "string" }] } </pre> | | | | |
| Rules | No. | Rule description | Error code | Error message | Attributes |
| | 1. | The order status must be Completed. | 2010 | Invalid report order status. | orderId |
| | 2. | According to the submitted order number: [orderId], the order does not exist. | 2016 | Report order doesn't exist in the system. | orderId |
| | 3. | Invalid method selected or parameter specified incorrectly. According to the submitted order number: [orderId] report type is: [orderType] | 2017 | Invalid method selected for report data or incorrect parameter. | orderId orderType |
| | 4. | No data found based on the search parameters submitted in the POST method. | 2018 | There is no data for the selected search parameters, the response is empty. | orderId |
| | 5. | The number of objects in the return list must be less than or equal to 10000. | 2022 | The number of objects on the list has been exceeded. | count |

7.3.17.1 JSON Request structure

The table below describes the structure of the JSON request:

| No. | Attribute | type | obligation | description |
|-----|-----------|------|------------|-------------|
| | | | | |

7.3.17.2 JSON Response structure

The table below describes the structure of the JSON response:

| No. | Attribute | type | obligation | description |
|-----|------------|------------|------------|--------------|
| 1. | personCode | String(20) | required | Person code. |

| | | | | |
|-----------------|---------------------|-------------|----------|---|
| 2. | personName | String(200) | required | Person name / company name. |
| 3. | personSurname | String(50) | required | Person surname. |
| 4. | objectId | Integer | required | Object ID. |
| 5. | objectNumber | String(20) | required | Object number. |
| meters:[] | | | | |
| 6. | meterNumber | String(20) | required | Meter number of the object. |
| categories:[] | | | | |
| 7. | consumptionCategory | String(2) | required | Consumption category. Possible meanings: <ul style="list-style-type: none"> • P+; • P-; • Q+; • Q-. |
| consumptions:[] | | | | |
| 8. | consumptionTime | Datetime | required | Consumption time. Example of consumptionTime format: 2022-06-07T00:00:00+02:00 2022-06-07T00:00:00+03:00 |
| 9. | amount | Number | required | Consumption amount. |
| 10. | valueType | String(3) | required | Consumption value type. Possible meanings: <ul style="list-style-type: none"> • EST – estimated; • VAL – validated. |

7.3.17.3 Error Response Structure

The following table describes the JSON structure in the event of a response error:

| No. | Attribute | type | obligation | description |
|-----|-----------|--------------|------------|----------------|
| 1. | code | number | required | Error code. |
| 2. | text | string(4000) | required | Error message. |

7.3.18 GET /gateway/order/{orderId}/report-obj-acr

| | | | |
|---------------------------|--|---------------|--|
| URI | GET /gateway/order/{orderId}/report-obj-acr?first={integer}&count={integer} | | |
| Description | The method for used to the order report "Report of objects by granted rights". | | |
| Parameters | <p>URL parameters:</p> <p>orderId – order identification number</p> <p>first - the index of the object, which must be the first in the return list (starting from 0). Optional. The default value is 0.</p> <p>count - the number of objects in the return list. Optional. The default value is 10000. If no count value is given, the default value count will be 10000.</p> | | |
| Header | After decrypting the supplier authentication key, the supplier ID is used to select the data. | | |
| JSON request | | | |
| Response HTTP code | HTTP status code | Reason | Description |
| | 200 | OK | Request completed successfully. |
| | 204 | No content | No data found according to the given parameters. |
| | 400 | Bad Request | Request error. The HTTP response body provides a list of errors in JSON format. (<i>Error response of the JSON structure below</i>). |
| | 401 | Unauthorized | An attempt was made to connect to a non-public method that requires authentication, but no user credentials were provided. |
| | 403 | Forbidden | According to the access control policy, the current user does not have access to perform the requested action. |
| | 404 | Not Found | Either there is no API method associated with the request URL path, or the request contains one or more parameters that did not return the data. |
| JSON response | <pre>[{ "consumerCode":"string", "personCode":"string", "personName":"string",</pre> | | |

| | |
|----------------------------|--|
| | <pre> "personSurname": "string", "objectId": "number", "objectNumber": "string", "objectName": "string", "objectType": "string", "objectAddress": "string", "contractType": "string", "contractModel": "string", "permissiblePowerConsumption": "number", "permissiblePowerGeneration": "number", "metersAmount": "number", "autoMetersAmount": "number", "smartMeterInstallationDate": "date", "supplyState": "string", "supplyStateFrom": "date", "supplyStateTo": "date", "consumptionState": "string", "consumptionStateFrom": "date", "consumptionStateTo": "date", "productsAmount": "number", "scalesAmount": "number", "technologicalCosts": "boolean", "payoffMethod": "string", "generatingObjectType": "string", "generatingObjectTypeFrom": "date", "generatingObjectTypeTo": "date", "powerPlantType": "string", "voltage": "number", "tariffPlan": "string", "tariffPlanChangeDate": "date", "timeZone": "string", "consumptionAverage": "double", "consumptionAverageCalculationDate": "datetime", "consumptionAverageCalculationMonthsCount": "integer" }] </pre> |
| JSON error response | <pre> { "errorMessages": [{ </pre> |

| | <pre> "code": 0, "text": "string" }] } </pre> | | | | |
|-------|--|--|------------|---|----------------------|
| Rules | No. | Rule description | Error code | Error message | Attributes |
| | 1. | The order status must be Completed. | 2010 | Invalid report order status. | orderId |
| | 2. | According to the submitted order number: [orderId], the order does not exist. | 2016 | Report order doesn't exist in the system. | orderId |
| | 3. | Invalid method selected or parameter specified incorrectly. According to the submitted order number: [orderId] report type is: [orderType] | 2017 | Invalid method selected for report data or incorrect parameter. | orderId orderType |
| | 4. | No data found based on the search parameters submitted in the POST method. | 2018 | There is no data for the selected search parameters, the response is empty. | orderId |

7.3.18.1 JSON Request structure

The table below describes the structure of the JSON request:

| No. | Attribute | type | obligation | description |
|-----|-----------|------|------------|-------------|
| | | | | |

7.3.18.2 JSON Response structure

The table below describes the structure of the JSON response:

| No. | Attribute | type | obligation | description |
|-----|-----------|------|------------|--|
| 1. | - | - | - | Response description are provided in https://datahub.eso.lt/dokumentacija . In next document version, all fields description will be provided here. |

7.3.18.3 Error Response Structure

The following table describes the JSON structure in the event of a response error:

| No. | Attribute | type | obligation | description |
|-----|-----------|--------------|------------|----------------|
| 1. | code | number | required | Error code. |
| 2. | text | string(4000) | required | Error message. |

7.3.19 GET /gateway/order/{orderId}/data-sum-obj-lvl-acr

| | | | |
|---------------------------|---|---------------|--|
| URI | GET /gateway/order/{orderId}/data-sum-obj-lvl-acr?first={integer}&count={integer} | | |
| Description | The method is used to obtain the requested "Aggregate quantities by entitlement" report. | | |
| Parameters | <p>URL parameters:</p> <p>orderId – order identification number</p> <p>first - the index of the object, which must be the first in the return list (starting from 0). Optional. The default value is 0.</p> <p>count - the number of objects in the return list. Optional. The default value is 10000. If no count value is given, the default value count will be 10000.</p> | | |
| Header | After decrypting the supplier authentication key, the supplier ID is used to select the data. | | |
| JSON request | | | |
| Response HTTP code | HTTP status code | Reason | Description |
| | 200 | OK | Request completed successfully. |
| | 204 | No content | No data found according to the given parameters. |
| | 400 | Bad Request | Request error. The HTTP response body provides a list of errors in JSON format. (<i>Error response of the JSON structure below</i>). |
| | 401 | Unauthorized | An attempt was made to connect to a non-public method that requires authentication, but no user credentials were provided. |

| | | | |
|--|-----|-----------|--|
| | 403 | Forbidden | According to the access control policy, the current user does not have access to perform the requested action. |
| | 404 | Not Found | Either there is no API method associated with the request URL path, or the request contains one or more parameters that did not return the data. |

| | | | |
|----------------------|---|--|--|
| JSON response | <pre>[{ "personCode":"string", "personName":"string", "personSurname":"string", "objectId":"number", "objectNumber":"string", "products":[{ "productCode":"string", "productName":"string", "productType":"string", "unit":"string", "consumptionCategories": [{ "category":"string", "consumptions":[{ "billingPeriod":"date", "consumptionAmount":"number", "productConsumptionType":"string" }] }] }] }]</pre> | | |
|----------------------|---|--|--|

| | | | | | |
|----------------------------|---|--|-------------------|---|----------------------|
| | <pre> }] </pre> | | | | |
| JSON error response | <pre> { "errorMessages": [{ "code": 0, "text": "string" }] } </pre> | | | | |
| Rules | No. | Rule description | Error code | Error message | Attributes |
| | 1. | The order status must be Completed. | 2010 | Invalid report order status. | orderId |
| | 2. | According to the submitted order number: [orderId], the order does not exist. | 2016 | Report order doesn't exist in the system. | orderId |
| | 3. | Invalid method selected or parameter specified incorrectly. According to the submitted order number: [orderId] report type is: [orderType] | 2017 | Invalid method selected for report data or incorrect parameter. | orderId orderType |
| | 4. | No data found based on the search parameters submitted in the POST method. | 2018 | There is no data for the selected search parameters, the response is empty. | orderId |

7.3.19.1 JSON Request structure

The table below describes the structure of the JSON request:

| No. | Attribute | type | obligation | description |
|-----|-----------|------|------------|-------------|
| | | | | |

7.3.19.2 JSON Response structure

The table below describes the structure of the JSON response:

| No. | Attribute | type | obligation | description |
|-----|-----------|------|------------|-------------|
| | | | | |

| | | | | |
|--------------------------|------------------------|--------------|--------------|--|
| 1. | personCode | String(20) | required | Person code. |
| 2. | personName | String(20) | required | Person name. |
| 3. | personSurname | String(50) | not required | Person surname. |
| 4. | objectId | number | required | Object ID. |
| 5. | objectNumber | String | required | Object number. |
| Products:[] | | | | |
| 6. | productCode | String(20) | not required | Product code. |
| 7. | productName | String(4000) | not required | Product name. |
| 8. | productType | String(5) | required | Product type. |
| 9. | unit | String(255) | not required | The unit of the product. |
| consumptionCategories:[] | | | | |
| 10. | category | String(2) | required | Consumption category. |
| Consumptions:[] | | | | |
| 11. | billingPeriod | Datetime | required | Month in which electricity consumption is recorded. |
| 12. | consumptionAmount | number | required | The amount of the consumption |
| 13. | productConsumptionType | String(20) | not required | Type of the product consumption. Possible meanings: - AMS - Abonentinis mok. (Subscription fee) |

7.3.19.3 Error Response Structure

The following table describes the JSON structure in the event of a response error:

| No. | Attribute | type | obligation | description |
|-----|-----------|--------------|------------|----------------|
| 1. | code | number | required | Error code. |
| 2. | text | string(4000) | required | Error message. |

7.4 Object controller

7.4.1 POST /gateway/object/my/active/list

| | | | |
|---------------------------|---|---------------|---------------------------------|
| URL | POST /gateway/object/my/active/list?first={integer}&count={integer}&sortKey={string}&sortOrder={ASC/DSC} | | |
| Description | <p>The method is designed to obtain a list of valid objects in the contract according to the selection criteria. The method will be used before performing:</p> <ul style="list-style-type: none"> • owner change process • contract termination process • tariff plan change process | | |
| Parameter | <p>URL:</p> <ul style="list-style-type: none"> • first - index (starting from 0) of the object that must be presented first in the return list. Optional. The default value is 0. • count - number of objects in the return list. Optional. The default value is 30. • sort - possible value ASD,DSC. <p>The data of the JSON form request are presented in the HTTP request body (BODY) (Query JSON structure, below).</p> | | |
| Header | After decrypting the supplier authentication key, the supplier ID is used to select the data. | | |
| Request | <pre>{ "personCode": "string", "consumerCode": "string", "objectNumber": "string", "meterNumber": "string", "showObjectMeter": "boolean", "showObjectPower": "boolean", "showObjectState": "boolean" }</pre> | | |
| Response HTTP code | HTTP status code | Reason | Description |
| | 200 | OK | Request completed successfully. |

| | | | |
|--|-----|--------------|--|
| | 204 | No content | No data found according to the given parameters. |
| | 400 | Bad request | Request error. The HTTP response body provides a list of errors in JSON format. (<i>Error response of the JSON structure below</i>). |
| | 401 | Unauthorized | An attempt was made to connect to a non-public method that requires authentication, but no user credentials were provided. |
| | 403 | Forbidden | According to the access control policy, the current user does not have access to perform the requested action. |
| | 404 | Not found | Either there is no API method associated with the request URL path, or the request contains one or more parameters that did not return the data. |

Response

```
[
  {
    "objectNumber":"string",
    "objectAddress":"string",
    "objectName":"string",
    "objectType":"string",
    "timeLimitedObjectValidTo":"datetime",
    "ownershipDocumentNumber":"string",
    "ownershipDocumentDate":"date",
    "auctionDate":"date",
    "technologicalCosts":"boolean",
    "productsAmount":"integer",
    "scalesAmount":"integer",
    "metersAmount":"integer",
    "autoMetersAmount":"integer",
    "supplier":{
      "supplierType":"string",
      "contractStart":"date",
      "contractEnd":"date",
      "contractModel":"string"
    },
    "objectStates":[
  {
```

```
"stateType":"string",
"state":"string",
"stateValidFrom":"date",
"stateValidTo":"date"
}
],
"voltage":"double",
"powerPlantType":"string",
"powerPlantObjectNumber":"string",
"objectPowers":[
  {
    "powerType":"string",
    "power":"double",
    "reliabilityCategoryType":"string",
    "powerValidFrom":"date",
    "powerValidTo":"date"
  }
],
"generatingObject":{
  "generatingObjectType":"string",
  "payoffMethod":"string",
  "generatingObjectTypeFrom":"date",
  "generatingObjectTypeTo":"date"
},
"tariff":{
  "tariffPlan":"string",
  "timeZone":"string",
  "tariffPlanChangeDate":"date"
},
"meters":[
  {
    "meterNumber":"string",
    "meterTypeName":"string",
    "meterScaleLength":"number",
    "conversionPoss":"boolean",
    "meterAutomated":"boolean"
  }
],
"contract":{
  "consumerCode":"string",
  "contractType":"string",
```

```

"personName": "string",
"personSurname": "string",
"personCode": "string",
"personType": "string",
"personIndividual": "boolean",
"sociallyVulnerable": "boolean",
"contact": {
  "mobPhoneNoNetwork": "string",
  "mobPhoneNo2Network": "string",
  "mobPhoneInvoice": "string",
  "phoneNoNetwork": "string",
  "emailNetwork": "string",
  "email2Network": "string",
  "emailInvoice": "string",
  "correspondenceAddress": "string",
  „mobPhoneNoObject“: "string"
}
},
"consumptionAverage": "double",
"consumptionAverageCalculationDate": "datetime",
"consumptionAverageCalculationMonthsCount": "integer"
}
]

```

Error response

```

{
  "errorMessages": [
    {
      "code": 0,
      "text": "string"
    }
  ]
}

```

Rules

| No. | Rule description | Error code | Error message | Attributes |
|-----|---|------------|---------------|------------|
| 1. | If an attribute has defined possible values, the value index can be specified by specifying the | - | - | - |

| | | | | | |
|----|--|---|--|--|--|
| | | value of the attribute in the request. Indices of all possible values start from 0. | | | |
| 2. | One or more request parameters are required. | 1001 | One or more request parameters are required. | personCode, consumerCode, objectNumber, meterNumber | |
| 3. | No data found according to the given parameters. The returned set of objects is defined: <ul style="list-style-type: none"> • Only the valid objects of the current supplier must be returned; | HTTP 204 | - | supplyOwnership, contractStart, contractEnd | |
| 4. | The request parameter [showObjectMeter] values must be: <ul style="list-style-type: none"> • True or • False | - | - | showObjectMeter | |
| 5. | The request parameter [showObjectPower] values must be: <ul style="list-style-type: none"> • True or • False | - | - | | |
| 6. | The request parameter [showObjectState] values must be: <ul style="list-style-type: none"> • True or • False | - | - | showObjectState | |

7.4.1.1 JSON Request structure

The table below describes the structure of the JSON response:

| No. | Attribute | type | obligation | description |
|-----|-----------------|------------|--------------|--|
| 1. | personCode | String(20) | not required | Contract owner / tenant / company code. |
| 2. | consumerCode | String(20) | not required | Contract owner / tenant consumer code. |
| 3. | objectNumber | String(20) | not required | Object number. |
| 4. | meterNumber | String(20) | not required | Meter number. |
| 5. | showObjectMeter | Boolean | not required | Indication of whether meter information should be retrieved. |
| 6. | showObjectPower | Boolean | not required | Indication of whether power information should be retrieved. |
| 7. | showObjectState | Boolean | not required | Indication of whether object status information should be retrieved. |

7.4.1.2 JSON Response structure

The table below describes the structure of the JSON response:

| No | Attribute | type | obligation | description |
|----|--------------------------|--------------|--------------|---------------------------------|
| 1 | objectNumber | String(20) | required | Object number. |
| 3 | objectAddress | String(4000) | required | Full address of the object. |
| 5 | objectName | String(200) | not required | Object name. |
| 6 | objectType | String(200) | not required | Object type name. |
| 7 | timeLimitedObjectValidTo | Date | not required | Expire date of the term object. |
| 8 | ownershipDocumentNumber | String(20) | not required | Ownership document number. |

| No | Attribute | type | obligation | description |
|------|-----------------------|------------|--------------|--|
| 9 | ownershipDocumentDate | Date | not required | Ownership document date of number. |
| 10 | auctionDate | Date | not required | Date of acquisition of the object from the auction. |
| 11 | technologicalCosts | Boolean | not required | Indicator or object according to the latest data is accounted for technological costs. |
| 12 | productAmount | Number | not required | Products' amounts are counted at the level of the object. |
| 13 | scalesAmount | Number | not required | Scales' amounts are counted at the level of the object. |
| 14 | metersAmount | Number | not required | Meters' amounts are counted at the level of the object. |
| 15 | autoMetersAmount | Number | not required | Automated meters' amounts are counted at the level of the object. |
| 16 | supplier: {} | | | |
| 16.1 | supplierType | String(2) | required | Current supplier type. Possible meanings: <ul style="list-style-type: none"> • VT - public supplier; • GT - warranty supplier; • NT - independent supplier. |
| 16.2 | contractStart | Date | required | Start date of entry into force of the object at a supplier. (NT/VT/GT) |
| 16.3 | contractEnd | Date | not required | End date of entry into force of the object at a supplier. (NT/VT/GT) |
| 16.4 | contractModel | String(10) | required | Contract model of the object at a supplier (NT/VT/GT). |

| No | Attribute | type | obligation | description |
|------|------------------|-----------|--------------|--|
| | | | | <p>Contract model of the current object. Possible meanings:</p> <ul style="list-style-type: none"> • BSS - General contract bills; • 2S2S - Two contracts – Two bills. |
| 17 | objectStates: {} | | | |
| 17.1 | stateType | String(3) | not required | <p>Object state type. Possible meanings:</p> <ul style="list-style-type: none"> • ETB - Supply state; • VBS - Consumption state. |
| 17.2 | state | String | not required | <p>Power supply state of the object. Possible meanings:</p> <ul style="list-style-type: none"> • T - Supply; • P - Disconnected on request; • A - Disconnected under sanction; • R - Limited by sanction. <p>Power consumption state of the object. Possible meanings:</p> <ul style="list-style-type: none"> • N – Temporarily inactive; • V - Consuming; • A - Alleged. |
| 17.3 | stateValidFrom | Date | not required | Object state valid from. |
| 17.4 | stateValidTo | Date | not required | Object state valid to. |

| No | Attribute | type | obligation | description |
|------|------------------------|--------------|--------------|---|
| 18 | voltage | Double(5,2) | not required | Object voltage, kV. |
| 19 | powerPlantType | String(1) | not required | Type of the power plant. Possible meanings: <ul style="list-style-type: none"> • A - Waist • B - Biomass • H - Hydroelectric • K - Other • S - Solar • T - TEC • V - Wind |
| 20 | powerPlantObjectNumber | String(20) | not required | Power plant object number. |
| 21 | objectPowers:[] | | | |
| 21.1 | powerType | String(3) | not required | Object power type. Possible meanings: <ul style="list-style-type: none"> • LOG - Permissible power consumption.; • LGG - Permissible power generation; • IOG - Installed usable power; • IGG - Installed to generate power. |
| 21.2 | power | Double(10,3) | not required | Object power. |
| 21.3 | powerValidFrom | Date | not required | Object power valid from. |

| No | Attribute | type | obligation | description |
|------|--------------------------|-----------|--------------|--|
| 21.4 | powerValidTo | Date | not required | Object power valid to. |
| 21.5 | reliabilityCategoryType | String(1) | not required | Type of credibility of supply category. Possible meanings: <ul style="list-style-type: none"> • 1 - 1 category; • 2 - 2 category; • 3 - 3 category. |
| 22 | generatingObject: {} | | | |
| 22.1 | generatingObjectType | String(1) | not required | Generating consumer type. Possible meanings: <ul style="list-style-type: none"> • G – GV (Generating consumer); • N – NGV (Distant generating consumer). |
| 22.2 | generatingObjectTypeFrom | Date | not required | Generating consumer type valid from. |
| 22.3 | generatingObjectTypeTo | Date | not required | Generating consumer type valid to. |
| 22.4 | payoffMethod | String(1) | not required | Generating consumer payoff method. Possible meanings: <ul style="list-style-type: none"> • E – kWh – Recovered el. energy; • G - kW – Power plant installed capacity; • M - kWh ir kW – Mixed; • P - % - Payment percentage, |

| No | Attribute | type | obligation | description |
|------|----------------------|-------------|--------------|---|
| | | | | <ul style="list-style-type: none"> S – kWh – PP recovered electricity |
| 23 | tariff: {} | | | |
| 23.1 | tariffPlan | String(200) | not required | Tariff plan name. |
| 23.2 | tariffPlanCategory | String(200) | not required | Tariff plan category name. |
| 23.3 | timeZone | String | not required | <p>Object time zone. Possible meaning:</p> <ul style="list-style-type: none"> 1 - One; 2 - Two; VR - One with reactive; 4 - Four (Smart); DR - Differentiated with reactive; N - Not established. |
| 23.4 | tariffPlanChangeDate | Date | not required | Date of the tariff plan change. |
| 24 | meters: [] | | | |
| 24.1 | meterNumber | String(20) | required | Object meter number. |
| 24.2 | meterTypeName | String | not required | Meter type name. |
| 24.3 | meterScaleLength | Number | not required | Maximum number of scale marks installed (programmable) in the meter. |

| No | Attribute | type | obligation | description |
|------|----------------|-------------|--------------|--|
| 24.4 | conversionPoss | Boolean | required | Indication of whether conversion of the total readings of the meter scales is possible. |
| 24.5 | meterAutomated | Boolean | required | Indication of whether the meter has automated accounting. |
| 25 | contract: {} | | | |
| 25.1 | consumerCode | String(20) | required | Contract owner consumer code. |
| 25.2 | contractType | String(10) | required | Contract type. Possible meanings: <ul style="list-style-type: none"> • SBTS - Household contract; • SKMS - Commercial contract. |
| 25.3 | personName | String(200) | required | Contract owner name / company name. |
| 25.4 | personSurname | String(50) | not required | Contract owner surname. |
| 25.5 | personCode | String(20) | not required | Contract owner person / company code If the subject is individual, that person code must be encrypted: [*****][person code's 3 last symbols] |
| 25.6 | personType | String(10) | required | Contract owner / tenant person type. Possible meaning: <ul style="list-style-type: none"> • FAS - individual; • JAS - Juridical. |

| No | Attribute | type | obligation | description |
|------|-----------------------|--------------|--------------|---|
| 25.7 | personIndividual | Boolean | required | Indication of whether the contract owner / tenant is individual person. |
| 25.8 | sociallyVulnerable | Boolean | required | An indication of whether the owner/tenant of the object is socially vulnerable. |
| 26 | contact:{"} | | | |
| 26.1 | mobPhoneNoNetwork | String(12) | not required | Mobile phone number for network. |
| 26.2 | mobPhoneNo2Network | String(12) | not required | Extra mobile phone number for the network. |
| 26.3 | phoneNoNetwork | String(12) | not required | Phone number for network. |
| 26.4 | mobPhoneInvoice | String(12) | not required | Mobile phone number for invoice. Data has been returned if contract type is SKMS. |
| 26.5 | emailNetwork | String(49) | not required | Email address for the network. |
| 26.6 | email2Network | String(49) | not required | Extra email address for the network. |
| 26.7 | emailInvoice | String(50) | not required | Email address for the invoice. Data has been returned if the contract type is SKMS. |
| 26.7 | correspondenceAddress | String(4000) | not required | Correspondence address full name. |
| 26.8 | mobPhoneNoObject | String(12) | not required | Extra mobile phone number for failures. Data has been returned if the contract type is SKMS. |

| No | Attribute | type | obligation | description |
|-----|--|--------------|--------------|--|
| 27. | consumptionAverage | Double(15,2) | not required | P plus consumption average. |
| 28. | consumptionAverageCalculationDate | DateTime | not required | Date of consumption average calculation. |
| 29. | consumptionAverageCalculationMonthsCount | Integer | Not required | Months count of consumption average calculation. |

7.4.1.3 Error Response structure

The following table describes the JSON structure in the event of a response error:

| No. | Attribute | type | obligation | description |
|-----|-----------|--------------|------------|----------------|
| 1. | code | number | required | Error code. |
| 2. | text | string(4000) | required | Error message. |

7.4.2 POST /gateway/object/all/active/list

| | |
|--------------------|--|
| URI | POST /gateway/object/all/active/list?first={integer}&count={integer}&sortKey={string}&sortOrder={ASC/DSC} |
| Description | <p>The method is to obtain a list of objects at the time of awarding the contract, according to the selection criteria. The method will be used before performing:</p> <ul style="list-style-type: none"> • Owner and supplier change process • Supply change process |
| Parameters | <p>URL:</p> <ul style="list-style-type: none"> • first - index (starting from 0) of the object that must be presented first in the return list. Optional. The default value is 0. • count - number of objects in the return list. Optional. The default value is 30. • sort - possible values ASC, DSC. |

| | | | |
|---------------------------|--|---------------|--|
| | The data of the JSON form request are presented in the HTTP request body (BODY) (Query JSON structure, below). | | |
| Header | After decrypting the supplier authentication key, the supplier ID is used to select the data. | | |
| JSON request | <pre>{ "personCode": "string", "consumerCode": "string", "objectNumber": "string", "meterNumber": "string" "objectDataConsentSign": "boolean" }</pre> | | |
| Response HTTP code | HTTP status code | Reason | Description |
| | 200 | OK | Request completed successfully |
| | 204 | No Content | No data found according to the given parameters. |
| | 400 | Bad Request | Request error. The HTTP response body provides a list of errors in JSON format. (<i>Error response of the JSON structure below</i>). |
| | 401 | Unauthorized | An attempt was made to connect to a non-public method that requires authentication, but no user credentials were provided. |
| | 403 | Forbidden | According to the access control policy, the current user does not have access to perform the requested action. |
| | 404 | Not Found | Either there is no API method associated with the request URL path, or the request contains one or more parameters that did not return the data. |
| JSON response | <pre>[{ "personName": "string", "personSurname": "string", "personCode": "string", "consumerCode": "string", "objectNumber": "string", "metersAmount": "integer",</pre> | | |

```
"autoMetersAmount": "integer",
"smartMeterInstallationDate": "date",
"meters": [
  {
    "meterNumber": "string",
    "meterAutomated": "boolean",
    "automationSystem": "string"
  }
],
"objectAddress": "string",
"contractType": "string",
"contractModel": "string",
"supplierType": "string",
"timeLimitedObjectValidTo": "datetime",
"tariffPlan": "string",
"tariffPlanChangeDate": "date",
"timeZone": "string",
"generatingObjectType": "string",
"payoffMethod": "string",
"ownershipDocumentNumber": "string",
"supplyOwnership": "string",
"contractStart": "date",
"contractEnd": "date",
"objectFutureSuppliers": [
  {
    "supplierCode": "string",
    "supplierName": "string",
    "contractStart": "date",
    "contractEnd": "date"
  }
],
"powerPlantType": "string",
"powerPlantObjectNumber": "string",
"objectPowers": [
  {
    "powerType": "string",
    "power": "double",
    "powerValidFrom": "date",
    "powerValidTo": "date"
  }
],
```

| | | | | | |
|----------------------------|---|--|-------------------|---|---|
| | <pre> "objectLatestSupplyState": { "state": "string", "stateValidFrom": "date", "stateValidTo": "date" }, "consumptionAverage": "double", "consumptionAverageCalculationDate": "datetime", "consumptionAverageCalculationMonthsCount": "integer" }] </pre> | | | | |
| JSON error response | <pre> { "errorMessages": [{ "code": 0, "text": "string" }] } </pre> | | | | |
| Rules | No. | Rule description | Error code | Error message | Attributes |
| | 0. | If an attribute has defined possible values, the value index can be specified by specifying the value of the attribute in the request. Indices of all possible values start from 0. | - | - | All attributes with specified values. |
| | 1. | One or more request parameters are required. | 1001 | One or more request parameters are required. | personCode, consumerCode, objectNumber, meterNumber |
| | 2. | No data found according to the given parameters. The returned set of objects is defined: <ul style="list-style-type: none"> Valid contract objects of all suppliers' must be returned. | HTTP 204 | - | contract.conclusion_date |
| | 3. | The request parameter [objectDataConsentSign] =TRUE is required. | 47 | It is mandatory to specify a request parameter in order | objectDataConsentSign |

| | | | | | |
|--|----|---|------|--|-----------------------|
| | | | | to obtain consent to see object information. | |
| | 4. | The attribute [objectDataConsentSign] values must be: <ul style="list-style-type: none"> • True or • False. | - | - | objectDataConsentSign |
| | 5. | A maximum of 500 objects can be specified. | 2021 | A maximum of 500 objects can be specified. | objectNumbers |

7.4.2.1 JSON Request structure

The table below describes the structure of the JSON response:

| No. | Attribute | type | obligation | description |
|-----|-----------------------|------------|--------------|--|
| 1. | personCode | String(20) | not required | Person / company code. |
| 2. | consumerCode | String(20) | not required | Consumer code. |
| 3. | objectNumbers | ["string"] | not required | Object number. A maximum of 500 objects can be specified |
| 4. | meterNumber | String(20) | not required | Meter number. |
| 5. | objectDataConsentSign | Boolean | not required | Object data consent sing. True or False. |

7.4.2.2 JSON Response structure

The table below describes the structure of the JSON response:

| No. | Attribute | type | obligation | description |
|-----|---------------|-------------|--------------|--|
| 1. | personName | String(200) | required | Contract owner / tenant name / company name. |
| 2. | personSurname | String(50) | not required | Contract owner / tenant surname. |
| 3. | personCode | String(20) | not required | Contract owner / tenant person / company code. |

| No. | Attribute | type | obligation | description |
|------|----------------------------|--------------|--------------|--|
| | | | | If the subject is individual, that person code must be encrypted: [*****][person code's 3 last symbols] |
| 4. | consumerCode | String(20) | required | Contract owner / tenant consumer code. |
| 5. | objectNumber | String(20) | required | Object number. |
| 6. | meterAmount | Number | not required | The number of meters is calculated at the object level. |
| 7. | autoMetersAmount | Number | not required | The number of automated meters is calculated at the object level. |
| 8. | smartMeterInstallationDate | Date | not required | Date of installation of the object`s smart meter. |
| 9. | meters:[] | | | |
| 9.1. | meterNumber | String(20) | required | Number of the object meter. |
| 9.2. | meterAutomated | Boolean | required | An indication of whether the meter has automated accounting. |
| 9.3. | automationSystem | String(20) | not required | Automated meter system. Possible values: <ul style="list-style-type: none"> • MDM (new MDM system, smart meters) • EMCOS (existing EMCOS system, automated meters) • NULL |
| 10. | objectAddress | String(4000) | required | Full title of the object address. |
| 11. | contractType | String(10) | required | Contract type of the current object. Possible meanings: <ul style="list-style-type: none"> • SBTS - Household customer; • SKMS - Commercial customer. |
| 12. | contractModel | String(10) | required | Contract model of the current object. Possible meanings: <ul style="list-style-type: none"> • BSS - General contract bills; • 2S2S - Two contracts – Two bills. |

| No. | Attribute | type | obligation | description |
|-----|--------------------------|-------------|--------------|--|
| 13. | supplierType | String(2) | not required | Current supplier type. Possible meanings: <ul style="list-style-type: none"> • VT - public supplier; • GT - warranty supplier; • NT - independent supplier. |
| 14. | timeLimitedObjectValidTo | DateTime | not required | Expiry date of the time-limited object |
| 15. | tariffPlan | String(200) | required | Current tariff plan of the object. |
| 16. | tariffPlanChangeDate | Date | Not required | Tariff plan change date. |
| 17. | timeZone | String(2) | required | Current time zone of the object. Possible meanings: <ul style="list-style-type: none"> • 1 - One; • 2 - Two; • VR - One with reactive; • 4 - Four (Smart); • DR - Differentiated with reactive; • N - Not established. |
| 18. | generatingObjectType | String(1) | not required | Generating consumer type. Possible meanings: <ul style="list-style-type: none"> • G – GV (Generating consumer); • N – NGV (Distant generating consumer). |
| 19. | payoffMethod | String(1) | not required | Current pay of method of the generating consumer. Possible meanings: <ul style="list-style-type: none"> • E – kWh – Recovered electricity; • G - kW – The power plant's permissible power; • P - % - Payment percentage; • S – kWh – PP recovered electricity. |
| 20. | ownershipDocumentNumber | String(20) | not required | Ownership document number. |

| No. | Attribute | type | obligation | description |
|-------|--------------------------|------------|--------------|--|
| 21. | supplyOwnership | String(20) | not required | Possible values: <ul style="list-style-type: none"> • MY - the object belongs to the independent supplier; • NOT_MY - the object does not belong to the independent supplier. Note: For VT / GT case, the value NOT_MY will always be returned. For NT case, the value will be returned according to whether the supplier initiating the action coincides with the supplier of the object. |
| 22. | contractStart | Date | not required | Contract start date with independent supplier. Returns only if supplyOwnership = MY. Otherwise, NULL is returned. |
| 23. | contractEnd | Date | not required | Contract end date with independent supplier. Returns only if supplyOwnership = MY. Otherwise, NULL is returned. |
| 24 | objectFutureSuppliers:[] | | | |
| 24.1 | supplierCode | String | not required | Future independent supplier code. |
| 24.2 | supplierName | String | not required | Future independent supplier name. |
| 24.3 | contractStart | Date | not required | Contract start date with future independent supplier. |
| 24..5 | contractEnd | Date | not required | Contract end date with future independent supplier. |
| 25. | powerPlantType | String(1) | not required | Type of the power plant. Possible meanings: <ul style="list-style-type: none"> • A - Waist • B - Biomass • H - Hydroelectric • K - Other • S - Solar • T – TEC • V - Wind |

| No. | Attribute | type | obligation | description |
|------|-------------------------|--------------|--------------|---|
| 26. | powerPlantObjectNumber | String(20) | not required | Power plant object number. |
| 27. | objectPowers:[] | | | |
| 27.1 | powerType | String(3) | not required | Object power type. Possible meanings: <ul style="list-style-type: none"> • LOG - Permissible power consumption.; • LGG - Permissible power generation; • IOG - Installed usable power; • IGG - Installed to generate power. |
| 27.2 | power | Double(10,3) | not required | Object power. |
| 27.3 | powerValidFrom | Date | not required | Object power valid from. |
| 27.4 | powerValidTo | Date | not required | Object power valid to. |
| 28. | objectLatestSupplyState | | | |
| 28.1 | state | String | not required | Power supply state of the object. Possible meanings: <ul style="list-style-type: none"> • T – Supply; • P – Disconnected on request; • A – Disconnected under sanction; • R – Limited by sanction. |

| No. | Attribute | type | obligation | description |
|------|--|--------------|--------------|--|
| 28.2 | stateValidFrom | Date | not required | Object state valid from. |
| 28.3 | stateValidTo | Date | not required | Object state valid to. |
| | | | | |
| 29. | consumptionAverage | Double(15,2) | not required | P plus consumption average. |
| 30. | consumptionAverageCalculationDate | Datetime | not required | Date of consumption average calcucalation. |
| 31. | consumptionAverageCalculationMonthsCount | Integer | not required | Months count of consumption average calculation. |

7.4.2.3 Error Response structure

The following table describes the JSON structure in the event of a response error:

| No. | Attribute | type | obligation | description |
|-----|-----------|--------------|------------|----------------|
| 1. | code | number | required | Error code. |
| 2. | text | string(4000) | required | Error message. |

7.5 Notification contract controller

7.5.1 POST /gateway/notification/contract/list

| | |
|--------------------|--|
| URI | POST /gateway/notification/contract/list?first={integer}&count={integer}&sortOrder={ASC/DSC} |
| Description | Method to obtain change information of the contract owner / contract owner and supplier / supplier . |

| | | | |
|---------------------------|--|---------------|--|
| Parameters | <p>URL:</p> <p>first - the index of the notification, which must be the first in the return list (starting from 0). Optional. The default value is 0. count - the number of notification rows in the return list. Optional. The default value is 30. sort - possible values ASC, DSC.</p> <p>The data of the JSON form request are presented in the HTTP request body (BODY) (Query JSON structure, below).</p> | | |
| Header | After decrypting the supplier authentication key, the supplier ID is used to select the data. | | |
| JSON request | <pre>{ "personCode": "string", "objectNumber": "string", "notificationId": "number", "contractStartFrom": "datetime", "contractStartTo": "datetime", "submittedDateFrom": "datetime", "submittedDateTo": "datetime", "status": ["string"], "userNameSearch": "string", "changeType": ["string"] "supplierContractNo": "string", "objectAddressSearch": "string" }</pre> | | |
| Response HTTP code | HTTP status code | Reason | Description |
| | 200 | OK | Request completed successfully |
| | 204 | No Content | No data found according to the given parameters. |
| | 400 | Bad Request | Request error. The HTTP response body provides a list of errors in JSON format. (<i>Error response of the JSON structure below</i>). |
| | 401 | Unauthorized | An attempt was made to connect to a non-public method that requires authentication, but no user credentials were provided. |
| | 403 | Forbidden | According to the access control policy, the current user does not have access to perform the requested action. |

| | | | |
|----------------------|--|-----------|--|
| | 404 | Not Found | Either there is no API method associated with the request URL path, or the request contains one or more parameters that did not return the data. |
| JSON response | <pre>[{ "notificationId":"number", "changeType":"string", "contractType":"string", "contractStart":"date", "supplierContractNo":"string", "notes":"string", "userName":"string", "submittedDate":"dateTime", "latestStatus":"string", "errorType":"string", "correspondenceAddress":{ "addressLine":"string", "street":"string", "building":"string", "housingNo":"string", "apartment":"string", "locality":"string", "eldership":"string", "municipality":"string", "county":"string" }, "ownerInfo":{ "subjectType":"string", "personName":"string", "personSurname":"string", "personCode":"string", "birthDate":"date", </pre> | | |

```
"vatCode":"string",
"representativeName":"string",
"representativeSurname":"string",
"representativeDuty":"string",
"contacts":{
  "mobPhoneNoNetwork":"string",
  "mobPhoneNo2Network":"string",
  "mobPhoneNoInvoice":"string",
  "telPhoneNoNetwork":"string",
  "emailNetwork":"string",
  "email2Network":"string",
  "emailInvoice":"string"
}
},
"contractNotificationStatus":[
  {
    "status":"string",
    "statusDate":"datetime"
  }
],
"objects":[
  {
    "objectNumber":"string",
    "objectAddress":"string",
    "contractModel":"string",
    "tariffPlan":"string",
    "timeZone":"string",
    "payoffMethod":"string",
    "objectNtr":"string",
    "objectNtrDate":"date",
    "uniqueRoomNo":"string",
    "ntGetCoownerConsent":"boolean",
```

| | |
|-----------------------------------|--|
| | <pre> "auctionDate":"date", "anotherSupplierContractCancellation":"string", "cancelledByAnotherSupplier":"boolean" }], "oldContractInfo":[{ "contractType":"string", "consumerCode":"string", "object":{ "objectNumber":"string", "meterNumbers":[string], "objectAddress":"string", "contractModel":"string", "tariffPlan":"string", "timeZone":"string", "ownershipDocumentNumber":"string", "ntGetCoownerConsent":"boolean", "auctionDate":"datetime", "payoffMethod":"string" } }] }] </pre> |
| <p>JSON error response</p> | <pre> { "errorMessages": [{ "code": 0, "text": "string" }] } </pre> |

| Rules | No. | Rule description | Error code | Error message | Attributes |
|-------|-----|---|------------|--|--|
| | 0. | If an attribute has defined possible values, the value index can be specified by specifying the value of the attribute in the request. Indices of all possible values start from 0. | - | - | All attributes with specified values. |
| | 1. | No data found according to the given parameters. | HTTP 204 | - | - |
| | 2. | One or more request parameters are required. | 1001 | One or more request parameters are required. | personCode, objectNumber, notificationId |
| | 3. | DateFrom cannot be later than DateTo. Equal can be. | 1002 | DateFrom cannot be later than DateTo. | dateFrom |

7.5.1.1 JSON Request structure

The table below describes the structure of the JSON response:

| No. | Attribute | type | obligation | description |
|-----|-------------------|------------|--------------|---|
| 1. | personCode | String(20) | not required | Person / company code. |
| 2. | objectNumber | String(20) | not required | Object number. |
| 3. | notificationId | Integer | not required | Notification ID. |
| 4. | contractStartFrom | DateTime | not required | Contract start date from. |
| 5. | contractStartTo | DateTime | not required | Contract start date to. |
| 6. | submittedDateFrom | DateTime | not required | Submitted date from. |
| 7. | submittedDateTo | DateTime | not required | Submitted date to. |
| 8. | status | [String] | not required | Notification status. Possible meanings: <ul style="list-style-type: none"> • P – Submitted |

| No. | Attribute | type | obligation | description |
|-----|---------------------|--------------|--------------|---|
| | | | | <ul style="list-style-type: none"> • I - Sent • A - Cancelled • V - In progress • IV - Completed • K – Error |
| 9. | userNameSearch | String(240) | not required | The user who created a notification. |
| 10. | changeTye | [String] | not required | Change type. Possible meanings: SK - Owner change; STK - Owner and supplier change; NTK – Supplier change. |
| 11. | supplierContractNo | String(30) | not required | Supplier contract number. |
| 12. | objectAddressSearch | String(4000) | not required | Object full address. |

7.5.1.2 JSON Response structure

The table below describes the structure of the JSON response:

| No. | Attribute | type | obligation | description |
|-----|----------------|------------|------------|---|
| 1. | notificationId | Integer | required | Notification ID. |
| 2. | changeType | String(10) | required | Change type. Possible meanings: SK - Owner change; STK - Owner and supplier change; NTK – Supplier change. |
| 3. | contractType | String(10) | required | Contract type. Possible meanings: SBTS - Household contract; SKMS - Commercial contract. |

| No. | Attribute | type | obligation | description |
|-----------------------|--------------------|--------------|------------------------------|--|
| 4. | contractStart | Date | required | Date of entry into force of the notification subject to the independent supplier from. |
| 5. | supplierContractNo | String(30) | not required | Contract number. Must be completed and is mandatory only in the change of owner and supplier / change of supplier . |
| 6. | notes | String(4000) | not required | Notes. |
| 7. | userName | String(240) | not required | The user, who created the post. |
| 8. | submittedDate | dateTime | required | Submitted date of notification. |
| 9. | latestSatus | String(10) | required | Latest status of notification. |
| 10. | errorType | String(10) | not required | Notification error type if status=K (Error). Possible meanings: <ul style="list-style-type: none"> • SP - The contract has already been rewritten • KL - Incorrect message • AG - Invalid person code / birth data • SN - Change of owner is not possible because the data in the old contract does not match • SK - The owner has a contract, the change of owner is not possible for the same person • DL - The owner has a contract, the independent supplier is assigned to the object. • NT - Cancellation at the Supplier's request • NO - client is not the owner of the object *Will be supplemented by the causes of errors of NTK process. |
| correspondenceAddress | | | | |
| 11. | addressLine | String(4000) | not required | Not structured full address title. |
| 12. | street | String(200) | not required | Street. |

| No. | Attribute | type | obligation | description |
|--------------------|-----------------------|-------------|--------------|--|
| 13. | building | String(100) | not required | House. |
| 14. | housingNo | String(100) | not required | Housing. |
| 15. | apartment | String(20) | not required | Flat. |
| 16. | locality | String(200) | not required | Town / Village. |
| 17. | eldership | String(200) | not required | Eldership. |
| 18. | municipality | String(200) | not required | Municipality. |
| 19. | county | String(200) | not required | Country. |
| ownerInfo | | | | |
| 20. | subjectType | String(10) | required | Contract owner / tenant person type. Possible meanings: FAS - individual; JAS - Juridical. |
| 21. | personName | String(200) | required | Contract owner / tenant / company name. |
| 22. | personSurname | String(50) | not required | Contract owner / tenant surname. |
| 23. | personCode | String(20) | not required | Contract owner / tenant person / company code |
| 24. | birthDate | Date | not required | Contract owner / tenant birth date. |
| 25. | vatCode | String(15) | not required | Contract owner / tenant VAT code. |
| 26. | representativeName | String(50) | not required | Representative name. |
| 27. | representativeSurname | String(50) | not required | Representative surname. |
| 28. | representativeDuty | String(100) | not required | Representative duty. |
| ownerInfo.contacts | | | | |
| 29. | mobPhoneNoNetwork | String(12) | not required | Mobile phone number for networks. |

| No. | Attribute | type | obligation | description |
|--|--------------------|-------------|--------------|--|
| | | | | Contact details for information on network work (accounting maintenance, electrical disconnections and faults). |
| 30. | mobPhoneNo2Network | String(12) | not required | Mobile phone number 2 for networks. Contact details for information on network work (accounting maintenance, electrical disconnections and faults). |
| 31. | mobPhoneNoInvoice | String(12) | not required | Mobile phone number for bills. Contact details for informing about formed invoices and provided services. |
| 32. | telPhoneNoNetwork | String(12) | not required | Phone number for networks. Contact details for information on network work (accounting maintenance, electrical disconnections and faults). |
| 33. | emailNetwork | String(49) | not required | An email address for networks. Contact details for information on network work (accounting maintenance, electrical disconnections and faults). |
| 34. | email2Network | String(49) | not required | An email address 2 for networks. Contact details for information on network work (accounting maintenance, electrical disconnections and faults). |
| 35. | emailInvoice | String(100) | not required | An email address for bills. Contact details for informing about formed invoices and provided services. |
| contractNotificationStatus(Status of the contract change notification) | | | | |
| 36. | status | String(10) | required | Notification status. Possible meanings: P – Submitted I - Sent A - Cancelled V - In progress IV - Completed K - Error. |

| No. | Attribute | type | obligation | description |
|-----------|---------------|--------------|--------------|--|
| 37. | statusDate | DateTime | required | Status date. |
| objects[] | | | | |
| 38. | objectNumber | String(20) | required | Object number. |
| 39. | objectAddress | String(4000) | required | Object address. |
| 40. | contractModel | String(10) | required | Contract model of the current object. Possible meanings: BSS - General contract bills; 2S2S - Two contracts – Two bills. |
| 41. | tariffPlan | String(200) | not required | Chosen tariff plane of the object. |
| 42. | timeZone | String(2) | not required | Current time zone of the object. Possible meanings: 1 - One; 2 - Two; VR - One with reactive; 4 - Four (Smart); DR - Differentiated with reactive; N - Not established. |
| 43. | payoffMethod | String(1) | not required | Chosen pay of method of the generating consumer. Possible meanings: E – kWh – Recovered electricity; G - kW – The power plant's permissible power; P - % - Payment percentage; S – kWh – PP recovered electricity. |
| 44. | objectNtr | String(20) | not required | Real estate cadaster and register number of the object of the State Enterprise Registers Center. |
| 45. | objectNtrDate | Date | not required | Date of the Real estate cadaster and register number of the object of the State Enterprise Register Center. |
| 46. | uniqueRoomNo | String(20) | not required | Unique room number. |

| No. | Attribute | type | obligation | description |
|------------------------|-------------------------------------|--------------|--------------|---|
| 47. | ntGetCoownerConsent | Boolean | required | Indication of whether the independent supplier has obtained the consent of the co-owner. Possible meanings: <ul style="list-style-type: none"> • True • False |
| 48. | auctionDate | Date | not required | Date of acquisition of the object from the auction. |
| 49. | anotherSupplierContractCancellation | String(4000) | not required | The field is filled in when contracts with another supplier are canceled with this notification. "Ši užklausa atšauké objekto sutartį su [independentSupplierName] datai [contractStart]" |
| 50. | cancelledByAnotherSupplier | boolean | not required | The field is filled in if the object of the notification was canceled with a notification from another supplier. Possible meanings: <ul style="list-style-type: none"> • True - "Ši objekto sutartis atšaukta kito tiekėjo" • False |
| oldContractInfo[] | | | | |
| 51. | contractType | String(10) | required | Contract type of the current object. Possible meanings: <ul style="list-style-type: none"> • SBTS - Household customer; • SKMS - Commercial customer. |
| 52. | consumerCode | String(20) | required | Consumer code. |
| oldContractInfo.object | | | | |
| 53. | objectNumber | String(20) | required | Object number. |
| 54. | meterNumbers | String(200) | not required | Object meter (meters). |
| 55. | objectAddress | String(4000) | required | Object address. |
| 56. | contractModel | String(10) | required | Contract model of the current object. Possible meanings: BSS - General contract bills; 2S2S - Two contracts – Two bills. |

| No. | Attribute | type | obligation | description |
|-----|-------------------------|-------------|--------------|---|
| 57. | tariffPlan | String(200) | required | Tariff plan of the object. |
| 58. | timeZone | String(2) | required | Current time zone of the object. Possible meanings: 1 - One; 2 - Two; VR - One with reactive; 4 - Four (Smart); DR - Differentiated with reactive; N - Not established. |
| 59. | ownershipDocumentNumber | String(20) | not required | Ownership document number. |
| 60. | ntGetCoownerConsent | Boolean | required | Indication of whether the independent supplier has obtained the consent of the co-owner. Possible meanings: True False |
| 61. | auctionDate | DateTime | not required | Date of acquisition of the object from the auction. |
| 62. | payoffMethod | String(1) | not required | Pay of method of the generating consumer. Possible meanings: E – kWh – Recovered electricity; G - kW – The power plant's permissible power; P - % - Payment percentage; S – kWh – PP recovered electricity. |

7.5.1.3 Error Response structure

The following table describes the JSON structure in the event of a response error:

| No. | Attribute | type | obligation | description |
|-----|-----------|--------------|------------|----------------|
| 1. | code | number | required | Error code. |
| 2. | text | string(4000) | required | Error message. |

7.5.2 POST /gateway/notification/contract

| | |
|---------------------|---|
| URI | POST /gateway/notification/contract |
| Description | The method is for NT to transfer contract owner / contract owner and supplier / supplier changes to DataHub. |
| Parameters | <p>URL:</p> <p>The data of the JSON form request are presented in the HTTP request body (BODY) (Query JSON structure, below).</p> |
| Header | After decrypting the supplier authentication key, the supplier ID is used to select the data. |
| JSON request | <pre>{ "changeType": "string", "contractType": "string", "contractStart": "date", "consentSign": "boolean", "supplierContractNo": "string", "notes": "string", "correspondenceAddress": { "street": "string", "building": "string", "housingNo": "string", "appartement": "string", "locality": "string", "eldership": "string", "municipality": "string", "county": "string" }, "ownerInfo": {</pre> |

```
"subjectType": "string",
"personName": "string",
"personSurname": "string",
"personCode": "string",
"birthDate": "date",
"vatCode": "string",
"representativeName": "string",
"representativeSurname": "string",
"representativeDuty": "string",
"contacts":
{
  "mobPhoneNoNetwork": "string",
  "mobPhoneNo2Network": "string",
  "mobPhoneNoInvoice": "string",
  "telPhoneNoNetwork": "string",
  "emailNetwork": "string",
  "email2Network": "string",
  "emailInvoice": "string"
}
},
"objects": [
{
  "objectNumber": "string",
  "tariffPlan": "string",
  "contractModel": "string",
  "timeZone": "string",
  "payoffMethod": "string",
  "objectNtr": "string",
  "objectNtrDate": "date",
  "uniqueRoomNo": "string",
  "ntGetCoownerConsent": "boolean",
  "auctionDate": "date"
```

| | | | | | | | | | <pre> }] } </pre> |
|---|---|------------------|--|-------|--------|------------|---------------|------------|--------------------|
| Response HTTP code | HTTP status code | Reason | Description | | | | | | |
| | 201 | Created | Request completed successfully | | | | | | |
| | 400 | Bad Request | Request error. The HTTP response body provides a list of errors in JSON format. (<i>Error response of the JSON structure below</i>). | | | | | | |
| | 401 | Unauthorized | An attempt was made to connect to a non-public method that requires authentication, but no user credentials were provided. | | | | | | |
| | 403 | Forbidden | According to the access control policy, the current user does not have access to perform the requested action. | | | | | | |
| | 404 | Not Found | Either there is no API method associated with the request URL path, or the request contains one or more parameters that did not return the data. | | | | | | |
| JSON response | <pre> { "notificationId": "number" } </pre> | | | | | | | | |
| JSON error response | <pre> { "errorMessages": [{ "code": 0, "text": "string" }] } </pre> | | | | | | | | |
| Rules | No. | Rule description | *SK | **STK | ***NTK | Error code | Error message | Attributes | |
| <p>*SK - the relevant rule for change of owner</p> <p>**STK - the relevant rule for change of owner and supplier</p> <p>***NTK – the relevant rule for change of supplier</p> | | | | | | | | | |

| | | | | | | | |
|----|---|---|---|---|---|---|--|
| 0. | If an attribute has defined possible values, the value index can be specified by specifying the value of the attribute in the request. Indices of all possible values start from 0. | + | + | + | - | If an attribute has defined possible values, the value index can be specified by specifying the value of the attribute in the request. Indices of all possible values start from 0. | - |
| 1. | Time-limited objects cannot be changed if they are expired. Ex.: If the time-limited object expiry date is 12-20 and the current date is 12-20 then 12-20=12-20 → the system displays error message; Ex.: If the time-limited object expiry date is 12-20 and the current date is 12-22 then 12-20<12-22 → the system displays error message; Ex.: If the time-limited object expiry date is 12-21 and the current date is 12-20 then 12-21>12-20 → there is no error. | + | + | - | 5 | Change not possible. Time-limited objects: [objectNumber (if there is more than one object, objects must be separated by the semicolon)] are expired. | object.time_limited_object_vali d_to, object.object_number, object.object_id, objectNumber |
| 2. | Submitted object cannot have the same / matching meters numbers. | + | + | + | 6 | Change not possible. Objects: [objectNumber (if there is more than one object, objects must be separated by the semicolon)] have the same / matching meter number. | object_meter.meter_number, object_meter.valid_from, object_meter.valid_to, object.object_number, object.object_id, objectNumber |
| 3. | The attribute [ObjectNumber] is mandatory. | + | + | + | - | - | objectNumber |
| 4. | The meaning of the [ObjectNumber] notification cannot be repeated. | + | + | + | 7 | The object: [objectNumber (if there is more than one | objectNumber |

| | | | | | | | |
|----|---|---|---|---|----|---|---|
| | | | | | | object, objects must be separated by the semicolon)] is repeating. | |
| 5. | Must be specified valid object. | + | + | + | 8 | The object: [objectNumber (if there is more than one object, objects must be separated by the semicolon)] not found in the system. | objectNumber |
| 6. | If changeType=SK , then the object must belong to a valid supplier contract that provides the notification and the object must have at least one valid meter. | + | - | - | 9 | The object: [objectNumber (if there is more than one object, objects must be separated by the semicolon)] does not belong to a valid supplier contract. | objectNumber, independentSupplierId, independent_supplier_objects. valid_from independent_supplier_objects. valid_to contract.conclusion_date |
| 7. | The attribute [subjectType] meaning must be: - FAS or - JAS . | + | + | + | - | - | subjectType |
| 8. | The attribute [contractType] meaning must be: - SBTS or - SKMS . | + | + | + | - | - | contractType |
| 9. | If the attribute [subjectType] = JAS , the attribute [contractType] meaning must be equal to SKMS . | + | + | + | 10 | If the contract owner / tenant person type is "Juridical", the contract type must be "SKMS" | subjectType, contractType |

| | | | | | | | |
|----------------|---|--------------|--------------|--------------|----------------|---|--|
| 9.1. | If the attribute [changeType] = NTK , the values of the attribute [contractType] and [subjectType] must match the current contract type of the object and the person type of the owner. | - | - | + | 129 | The contract type and the contract owner's person type must match the current contract type and the contract owner type. | contractType, subjectType, changeType |
| 10. | If changeType=SK/STK , then the attribute [contractStart] can be equal to the current date or later than current. Ex.: If the current date is 2021-02-08 , then [contractStart] start date can be any date inclusive from 2021-02-08 to X date in the future. | + | + | - | 11 | Date of the contract start [contractStart] can be equal to the current date or later then current. | contractStart, objectNumber, changeType |
| 10.1. | If changeType=NTK , then the attribute [contractStart] must be equal to the first day of the month. | - | - | + | 111 | Date of the contract start [contractStart] must be equal to the first day of the month. | contractStart, objectNumber, changeType |
| 11. | If changeType=NTK: during the submission of the notification, it is checked whether a contract for another or the same real estate has not been concluded for the object from a later date than the date of entry into force of the contract. If the contract for the object has already been concluded, an error message must occur and the date of submission of the concluded contract shall be indicated. | - | - | + | 112 | An information of the conclusion of the contract since [independent_supplier_object.valid_from] has already been submitted to the object [objectNumber]. | contractStart, objectNumber, changeType |
| 12. | If changeType=NTK , it is checked whether the date of entry into force of the contract is given correctly: Notifications of the concluded contract must be submitted by the day of the month specified in the configuration, | - | - | + | 113 | The effective date of the contract must not be less than [date] . | contractStart, objectNumber, changeType |

| | | | | | | | |
|-----|--|---|---|---|-----|---|--|
| | and the contract may enter into force at the earliest from the first day of the following month. Ex.: configuration date is 18 d. current date 2021-09-17 this is the earliest contract that can be concluded on October 1. current date 2021-09-20 this is the earliest contract that can be concluded on November 1. | | | | | | |
| 13. | If changeType=NTK : when submitting a new supplier change notification, the system must be checked for the presence of supplier change notification with a status not Canceled and not Error. | - | - | + | 116 | Due to possible duplication of information, such a notification to object [objectNumber] is not possible. Please try after 30 minutes. | contractStart, objectNumber, changeType |
| 14. | If changeType=NTK , then a change of supplier notice shall not be permitted if a change of owner and supplier notice is in progress. It should not be allowed only if the object number and the date of contract start force of the contract coincide in the notifications. | - | - | + | 117 | For object [object number (if more than one is separated by a semicolon)] , a change of supplier is already in progress with the owner and supplier change request | contractStart, objectNumber, changeType |
| 15. | In the context of the object, one irrevocable / infallible change of owner (SK) / owner and supplier (STK) request is possible for the same contract entry date. Another request can be submitted from the day following the entry into force of the latest request agreement found. <ul style="list-style-type: none"> If the object X does not have the notification of the owner / owner and supplier in the system with the status | + | + | - | 12 | The request to change owner / owner and supplier for objects [objectNumber (if more than one is separated by a semicolon)] has already been submitted. | objectNumber, contract_object_change_notification.object_number, contractStart, contract_object_change_notification.contract_start, changeType=SK, contract_change_notification.change_type=SK, contract_change_status.status=Priimtas |

"Įvykdytas" / "Vykdomas" /
"Pateiktas" / "Išsiųstas", then:

- The contract start date for the new notification must be chosen from the current day to X date in the future.
 - ex.: current date 2021-05-12, then the notification date can be 2021-05-12 to X date in the future;
- If the object X has the notification of the owner / owner and supplier in the system with the status "Įvykdytas" / "Vykdomas" / "Išsiųstas" / "Pateiktas", then:
- The latest date of entry into force of the contract from the notification must be checked AND
- the notification may be submitted from the date of entry into force of the latest notification contract found from the following day to X date in the future.
 - ex.: current 2021-05-12, found a message for the date 2021-05-14, and a message for the date 2021-05-21, this can provide dates from 2021-05-22 to X date in the future;
 - ex.: current 2021-05-12, found a message for the date 2021-05-14 and a message for the date 2021-06-01, this message can

| | | | | | | | |
|-----|--|---|---|---|-----|--|--|
| | provide dates from 2021-06-02 to X date in the future. | | | | | | |
| 16. | The attribute [contractStart] format must be: yyyy-mm-dd. yyyy - year; mm - month; dd - day. | + | + | + | - | - | contractStart |
| 17. | Mandatory attributes are: <ul style="list-style-type: none"> • [subjectType] and • [contractType] and • [contractStart]. | + | + | + | - | - | subjectType, contractType, contractStart |
| 18. | If the attribute [changeType]=STK/NTK then mandatory attribute is: - [supplierContractNo] | - | + | + | 14 | "Contract No." is mandatory. | supplierContractNo |
| 19. | The [contractModel] attribute must be: - BSS or - 2S2S . | + | + | + | - | - | contractModel, changeType |
| 20. | If the attribute [contractType]=SBTS then meaning of the [contractModel] attribute must be equal to BSS . | + | + | + | 16 | If the contract type is equal to "SBTS" then the contract model must be "BSS". | contractType, contractModel |
| 21. | If the attribute [changeType]=NTK , [contractType]=SBTS , It is possible to change the tariff plan (not null and does not match the current one) and/or time zone (not null and does not match the current one) of the object, if the possible date of changing the tariff plan and/or time zone is earlier than or equal to the date of "Contract start". | - | - | + | 131 | Change not possible. The object: [objectNumber] possible tariff plan change [date] date is later than the date of contract start. | tariffPlan, changeType, contractType, objectnumber |

| | | | | | | | |
|-----|--|---|---|---|-----|---|---|
| | If the attribute [changeType]=NTK , [contractType]=SKMS , It is possible to change the time zone (not null and does not match the current one) of the object, if the possible date of changing the tariff plan is earlier than or equal to the date of "Contract start". | | | | | | |
| 22. | If changeType=STK/NTK , then the object may be included in no more than one contract with the supplier, which indicates the same date of entry into force of the contract. | - | + | - | 108 | An information of the conclusion of the contract with [independent_supplier.name] since [independent_supplier_object.valid_from] has already been submitted to the object [objectNumber] . | changeType, objectNumber, independent_supplier_object |
| 23. | If the attribute [subjectType]=FAS then the mandatory attributes are: - [personName] and - [personSurname] and - [personCode] or [birthDate]. | + | + | + | 18 | If the person type of the contract owner / tenant is "Physical", the "Name" and "Surname" and "Personal identification code" or "Date of birth" are mandatory. | personName, personSurname, personCode, birthDate, subjectType |
| 24. | If the attribute [subjectType]=JAS then the mandatory attributes are: - [personName] and - [personCode]. | + | + | + | 19 | If the person type of the contract owner / tenant is "Juridical", then "Company Name" and "Company Code" are mandatory. | personName, personCode, subjectType |
| 25. | The attribute [birthDate] format must be: yyyy-mm-dd. yyyy - year; mm - month; dd - day. | + | + | + | - | - | birthDate |

| | | | | | | | |
|-----|---|---|---|---|----|---|---|
| 26. | <p>If changeType=SK/STK/NTK and if the attribute [contractType] = SBTS, then must be at least one contact attribute:</p> <ul style="list-style-type: none"> • [mobPhoneNoNetwork] or • [telPhoneNoNetwork] or • [emailNetwork]. | + | + | + | 20 | <p>If the contract type is "SBTS", it is mandatory to specify at least one attribute for network work: "Mobile phone no." or "Phone no." or "Email address".</p> | <p>mobPhoneNoNetwork, emailNetwork, contractType, changeType</p> |
| 27. | <p>If changeType=SK/STK/NTK and attribute [contractType] = SKMS then must be at least one contact attribute:</p> <p>- [mobPhoneNoNetwork] or - [telPhoneNoNetwork] or - [emailNetwork].</p> <p>and at least one contact attribute of the bills from:</p> <p>- [mobPhoneNoInvoice] or - [emailInvoice].</p> | + | + | + | 21 | <p>If the contract type is "SKMS", it is mandatory to specify one of the contacts for network work: "Mobile phone no." or "Email Address" and one of the contact for accounts: "Mobile Phone no." or "Email Address".</p> | <p>mobPhoneNoNetwork, emailNetwork, mobPhoneNoInvoice, emailInvoice, contractType, changeType</p> |
| 28. | <p>The format of the attributes [mobPhoneNoNetwork], [mobPhoneNo2Network], [mobPhoneNoInvoice] must be : +3706XXXXXXXX, X - an integer (0 must be included)</p> <p>The format of the attribute [telPhoneNoNetwork] must be : +370XXXXXXXX, X - an integer (0 must be included). The next number after +370 cannot be 6.</p> | + | + | + | 22 | <p>Mob. tel. No., mob. tel. No. (optional) and phone no. incorrect format.</p> | <p>mobPhoneNoNetwork, mobPhoneNo2Network, telPhoneNoNetwork, mobPhoneNoInvoice</p> |
| 29. | <p>The format of the attributes [emailNetwork], [email2Network], [emailInvoice] must be</p> | + | + | + | 23 | <p>An email address, optional email address and invoice email address incorrect format.</p> | <p>emailNetwork, email2Network, emailInvoice</p> |

| | | | | | | | |
|-------|---|---|---|---|-----|--|--|
| | [text][@][text][.domain], letters in the text must be Latin. Can be at most 49 characters up to @ symbol. | | | | | | |
| 30. | If changeType=SK/STK , then in the context of an object, one irrevocable / infallible change of owner / owner and supplier change request is possible for the same owner. The current contract owner cannot match the newly submitted owner. | + | + | - | 24 | The owner [personName personSurname (personSurname is displayed if subjectType = FAS)] has already been queried or the owner coincides with the owner of the current contract. | subjectType, personSurname, personName, personCode, birthDate, contractStart |
| 30.1. | If changeType = NTK , then in the context of the object, the provided owner must match the owner of the current contract. | - | - | + | 121 | The owner [personName personSurname (personSurname is displayed if subjectType = FAS)] does not match the owner of the current contract. Request a change of owner and supplier. | changeType, personCode, personName, personSurname, birthDate |
| 31. | If the attribute [contractType] = SBTS , then the meaning of the [tariffPlan] attribute must be: - Namai or - Namai plius or - Standartinis or - Išmanusis or - Vidutinė įtampa. | + | + | + | 27 | If the contract type is SBTS, then the tariff plan must be "Namai" / "Namai plius" / "Standartinis" / "Išmanusis" / "Vidutinė įtampa". | tariffPlan, contractType |
| 32. | If the attribute [changeType]=SK/STK and [contractType] = SBTS , then the mandatory attributes are: - [tariffPlan] and - [timeZone]. | + | + | - | 28 | If the contract type is "SBTS", it is mandatory to indicate "Tariff Plan" and "Time Zone". | tariffPlan, timeZone, contractType |

| | | | | | | | |
|-------|--|---|---|---|-----|---|------------------------------------|
| 32.1. | <p>If the attribute [changeType]=NTK, [contractType] = SBTS and if at least one attribute is specified:</p> <ul style="list-style-type: none"> - [tariffPlan] or - [timeZone] <p>Then both must be specified.</p> | - | - | + | 122 | <p>If the contract type is "SBTS" and "Tariff Plan" or "Time Zone" is specified, then both must be specified.</p> | tariffPlan, timeZone, contractType |
| 33. | <p>If the attribute [contractType] = SBTS and attribute [tariffPlan] = Išmanusis, then the attribute [timeZone] meaning must be:</p> <ul style="list-style-type: none"> • 4. | + | + | + | 29 | <p>If the contract type is SBTS and the tariff plan is "Išmanusis", then the time zone must be "4 (Smart)".</p> | timeZone, contractType, tariffPlan |
| 34. | <p>If the attribute [contractType] = SBTS and attribute [tariffPlan] = Namai / Namai plus / Standartinis / Vidutinė įtampa, then the attribute [timeZone] meaning must be:</p> <ul style="list-style-type: none"> - 1 or - 2. | + | + | + | 30 | <p>If the contract type is SBTS and the tariff plan is "Namai" or "Namai plus" or "Standartinis" or "Vidutinė įtampa", then the time zone must be One or Two.</p> | timeZone, contractType, tariffPlan |
| 35. | <p>The meaning of the [ntGetCoownerConsent] attribute must be:</p> <ul style="list-style-type: none"> - True or - False. | + | + | - | - | - | ntGetCoownerConsent |
| 36. | <p>The format of the [auctionDate] attribute must be: yyyy-mm-dd, yyyy - years, mm - month, dd - day.</p> | + | + | - | - | - | auctionDate |

| | | | | | | | |
|-----|---|---|---|---|----|--|--|
| 37. | The format of the [ObjectNtrDate] attribute must be: yyyy-mm-dd , yyyy - years, mm - month, dd - day. | + | + | - | - | - | objectNtrDate |
| 38. | The meaning of the [payoffMethod] attribute must be: - E or - G or - P or - S | + | + | + | - | - | payoffMethod |
| 39. | If the attribute [objectNtr] is filled then the [objectNtrDate] attribute is mandatory. | + | + | - | 31 | If the Real estate cadaster and register of the State Enterprise Centre of Registers object is filled in, the Real estate cadaster and register date of the State Enterprise Centre of Registers object must be indicated. | objectNtr, objectNtrDate |
| 40. | The meaning of the [consentSign] must be: - True or - False . | + | + | + | - | - | consentSign |
| 41. | If the attribute [consentSign] = False , then the modification must be disabled. | + | + | + | 32 | It is necessary to confirm that the data provided is correct. | consentSign |
| 42. | Upon successful creation of a change of owner / owner and supplier / supplier request, the status of the request becomes "Submitted". | + | + | + | - | - | contract_change_status.status, contract_change_status.status_date |
| 43. | Meaning of the mandatory attribute [changeType] must be: • SK or | + | + | + | - | - | changeType |

| | | | | | | | |
|-----|---|---|---|---|------|---|---|
| | <ul style="list-style-type: none"> • STK or • NTK | | | | | | |
| 44. | The supplier will be identified by the authentication key. | + | + | + | 1003 | The independent supplier cannot be found in the system or supplier is not active. | independent_supplier.id, contract_change_notification.independent_supplier_id |
| 45. | The [contractModel] attribute is mandatory. | + | + | + | - | - | contractModel, changeType |
| 46. | The attribute [contractModel] must match for all objects. | + | + | + | 148 | The contract model must match for all objects. | objectNumber, contractModel |
| 47. | If attribute changeType=NTK , then the attributes must not be specified: <ul style="list-style-type: none"> • objectNtr • objectNtrDate • auctionDate • ntGetCoownerConsent • uniqueRoomNo | - | - | + | 130 | If the change type is "Supplier change", the attributes must not be specified: "Object ntr", "Object ntr date", "Auction date", "NT get coowner consent", "Unique room No.". | objectNtr, objectNtrDate, auctionDate, ntGetCoownerConsent, uniqueRoomNo, changeType |
| 48. | If the attribute [contractType] = SBTS , must be specified valid [tariffPlan]. | + | + | + | 35 | There is no tariff plan [tariffPlan (if there is more than one object, objects must be separated by the semicolon)]. | tariffPlan, tariff_plan_category.tariff_plan_category_id, contract_object_change_notification.tariff_plan_category_id, contractType |
| 49. | The value of attribute [birthDate] cannot be later than the current date. | + | + | + | 37 | A birth date cannot be later than the current date. | birthdate |
| 50. | If the attribute [objectNtrDate] is filled then the [objectNtr] attribute is mandatory. | + | + | + | 38 | If date of the Real estate cadaster and register number of the object of the State Enterprise Register is filled, the Real estate cadaster and register number of the object of the State | objectNtr, objectNtrDate |

| | | | | | | | | |
|-----|---|---|---|---|-----|---|---|---|
| | | | | | | | Enterprise Registers Center must be included. | |
| 51. | If the attribute [changeType]=SK then attribute [supplierContractNo] cannot be filled. | + | - | | 39 | | If the contract type "SK", then supplier contract No. cannot be filled. | changeType, supplierContractNo |
| 52. | If changeType=SK/STK/NTK and If the attribute [contractType]=SBTS then attributes [mobPhoneNoInvoice] and [emailInvoice] cannot be filled. | + | + | + | 41 | | If the contract type "SBTS", then invoice mob. tel. No. and invoice email address cannot be filled. | contractType, mobPhoneNoInvoice, emailInvoice |
| 53. | If the attribute [changeType]=SK/STK, then the attribute [payoffMethod] cannot be field if consumer type is not generating consumer [generatingObjectType is not G] and [contractType is not SBTS]. | + | + | - | 42 | | Generating consumer payoff method can be field, if consumer type is GV and contract type - SBTS. | payoffMethod, generatingObjectType |
| 54. | If the attribute [changeType]=NTK, then the attribute [payoffMethod] cannot be field if consumer type is not generating consumer [generatingObjectType is not G] or field if consumer is not remote generating consumer [generatingObjectType is not N] and [contractType is not SBTS]. | - | - | + | 210 | | Generating consumer payoff method can be field, if consumer type is GV or NGV and contract type - SBTS. | payoffMethod, generatingObjectType |
| 56. | The attribute [timeZone] must be: <ul style="list-style-type: none"> • 1; • 2; • VR; • 4; • DR. | + | + | + | - | - | | timeZone |
| 57. | All objects of the notification must belong to the same contract. | + | + | + | 43 | | Change not possible. Different contracts for submitted objects. | objectNumber, consumerCode |

| | | | | | | | |
|-----|---|---|---|---|-----|--|--|
| 58. | If the attribute [subjectType] = FAS, then the attribute [personCode] must be 11 digits. If the attribute [subjectType] = JAS, then the attribute [personCode] must be 9 digits. | + | + | + | 44 | The personal code must consist of 11 digits, the company code - 9 digits. | subjectType, personCode |
| 59. | If the attribute [subjectType] = JAS, then the attributes [birthDate] and [personSurname] cannot be specified. | + | + | + | 45 | If the contract owner / tenant person type is "Juridical", the birth date and surname cannot be specified. | subjectType, birthDate, personSurname |
| 60. | If the attribute [subjectType] = FAS , then the attribute [personName] must be up to 50 symbols. | + | + | + | 46 | If the contract owner / tenant person type is "Individual", the name must be up to 50 symbols. | subjectType, personName |
| 61. | If the attribute [contractType] = SKMS and at least one of the attributes [representativeName] , [representativeSurname] , [representativeDuty] is specified, all three attributes must be filled in. | + | + | + | 141 | If the contract type is "SKMS" and at least one attribute of the representative is specified, all three attributes must be indicated: "Representative name", "Representative surname", "Representative duty". | contractType, representativeName, representativeSurname, representativeDuty |
| 62. | If the attribute [contractType] = SBTS, then the attributes [representativeName] , [representativeSurname] and [representativeDuty] cannot be specified. | + | + | + | 147 | If the contract type is "SBTS", the name, surname and the duty of the representative cannot be specified. | contractType, representativeName, representativeSurname, representativeDuty |
| 63. | If the attribute [contractType] = SBTS and the current tariff plan of object is "Vidutinė įtampa", then the | + | + | + | 48 | If the contract type is "SBTS" and the current tariff plan of object | tariffPlan, contractType |

| | | | | | | | |
|-----|---|---|---|---|-----|---|---|
| | new [tariffPlan] must be "Vidutinė įtampa". | | | | | [objectNumber] is "Vidutinė įtampa", then the new tariff plan must be "Vidutinė įtampa" | |
| 64. | If the attribute [contractType]=SBTS , then object tariffPlan=Vidutinė įtampa cannot be specified, if current tariffPlan of object is not "Vidutinė įtampa". | + | + | + | 49 | If the contract type "SBTS" and the current tariff plan of object [objectNumber] is not "Vidutinė įtampa", then the new tariff plan can be "Namai" / "Namai plius" / "Standartinis" / "Išmanusis". | tariffPlan, contractType |
| 65. | If the attribute [changeType]=SK/STK , [contractType]=SKMS , then attribute [timeZone] is required. | + | + | - | 123 | If the contract type is "SKMS" it is mandatory to indicate "Time zone". | contractType, changeType, timeZone |
| 66. | If the object contractType=SKMS and PermittablePowerConsumption <=30 kw, the attribute's [timeZone] possible values: <ul style="list-style-type: none"> • 1 or; • 2. | + | + | + | 124 | If the contract type is "SKMS" of the object: [objectNumber] and PermittablePowerConsumption <= 30 kw, then the time zone must be "One" or "Two". | contractType, changeType, timeZone, power |
| 67. | If the object contractType=SKMS and PermittablePowerConsumption > 30 kw, the attribute's [newTimeZone] possible values: <ul style="list-style-type: none"> • VR or; • DR. | + | + | + | 125 | If the contract type is "SKMS" of the object: [objectNumber] and permittable power consumption > 30 kw, then the time zone must be "One with reactive" or "Differentiated with reactive ones". | contractType, changeType, timeZone, power |
| 68. | If the attribute [changeType] = SK / STK , [contractType] = SKMS and the object failed to determine the valid | + | + | + | 127 | Failed to set usable power for the object [objectNumber]. | changeType, contractType, timeZone |

| | | | | | | | |
|-----|--|---|---|---|-----|--|--|
| | <p>usable power, the change is not possible.</p> <p>If the attribute [changeType] = NTK, [contractType] = SKMS and the attribute [timeZone] is specified, then if the object failed to determine the valid usable power, then the change is not possible.</p> | | | | | | |
| 69. | If the contractType=SKMS , then the attribute [tariffPlan] cannot be specified. | + | + | + | 126 | If the contract type is "SKMS", then the tariff plan cannot be specified. | contractType, changeType, tariffPlan |
| 70. | <p>If the changeType=SK/STK, then the attribute [ntGetCoownerConsent] is required.</p> <p>The meaning of the [ntGetCoownerConsent] attribute must be:</p> <ul style="list-style-type: none"> • True or • False. | + | + | - | 140 | The attribute "NT get coowner consent" is required. | ntGetCoownerConsent |
| 71. | <p>Attribute [changeType] is required.</p> <p>Values of attribute [changeType]:</p> <ul style="list-style-type: none"> • SK • STK • NTK | + | + | + | - | - | changeType |
| 72. | If the attribute [changeType] = NTK and [contractType] = SBTS and the object is a generating user = G (GV) and the attribute [payoffMethod] (not null) is specified, the payoff method can be changed if the date of the change in the GV payoff method is earlier or equal to the date of "Contract start". | - | - | + | 134 | Change not possible. Object: [objectNumber] possible generating capacity user payoff method change [date] date is later than the date of contract start. | changeType, contractType, payoffMethod |

| | | | | | | | | |
|--|-----|---|---|---|---|-----|--|---|
| | 73. | If [changeType]=NTK, the attribute [vatCode] must be left blank. | - | - | + | 150 | If the contract change type is "NTK", the VAT code is not filled in. | changeType, vatCode |
| | 74. | If [changeType]=SK/STK and [contractType]=SBTS, the attribute [vatCode] must be left blank. | + | + | - | 151 | If the contract change type is "SK" or "STK" and contract type is "SBTS", the VAT code is not filled in. | changeType, contractType, vatCode |

7.5.2.1 JSON Request structure

The table below describes the structure of the JSON request:

| No. | Attribute | type | obligation | description |
|-----|---------------|------------|------------|--|
| 1. | changeType | String(10) | required | Change type. Possible meanings: <ul style="list-style-type: none"> • SK - Owner change; • STK - Owner and supplier change. |
| 2. | contractType | String(10) | required | Contract type. Possible meanings: <ul style="list-style-type: none"> • SBTS - Household customer; • SKMS - Commercial customer. |
| 3. | contractStart | Date | required | Start date of entry into force of the contract at an independent supplier. |
| 4. | consentSign | Boolean | required | Indication of whether the data provided by the contract owner / owner and supplier are correct. Possible meanings: <ul style="list-style-type: none"> - True; - False. |

| No. | Attribute | type | obligation | description |
|-----------------------|--------------------|--------------|--------------|---|
| 5. | supplierContractNo | String(30) | not required | Contract number. |
| 6. | notes | String(4000) | not required | Notes. |
| correspondenceAddress | | | | |
| 7. | street | String(200) | not required | Street. |
| 8. | building | String(100) | not required | Building. |
| 9. | housingNo | String(100) | not required | Housing. |
| 10. | apartment | String(20) | not required | Flat. |
| 11. | locality | String(200) | not required | Town / Village. |
| 12. | eldership | String(200) | not required | Eldership. |
| 13. | municipality | String(200) | not required | Municipality. |
| 14. | county | String(200) | not required | County. |
| ownerInfo | | | | |
| 15. | subjectType | String(10) | required | Contract owner / tenant person type. Possible meaning: FAS - individual; JAS - Juridical. |
| 16. | personName | String(200) | required | Contract owner / tenant / company name. |
| 17. | personSurname | String(50) | not required | Contract owner / tenant surname. |
| 18. | personCode | String(20) | not required | Contract owner / tenant person / company code |
| 19. | birthDate | Date | not required | Contract owner / tenant birth date. |
| 20. | vatCode | String(15) | not required | Contract owner / tenant VAT code. |
| ownerInfo.contacts | | | | |

| No. | Attribute | type | obligation | description |
|-----------|--------------------|-------------|--------------|--|
| 21. | mobPhoneNoNetwork | String(12) | not required | Mobile phone number for networks. Contact details for information on network work (accounting maintenance, electrical disconnections and faults). |
| 22. | mobPhoneNo2Network | String(12) | not required | Mobile phone number 2 for networks. Contact details for information on network work (accounting maintenance, electrical disconnections and faults). |
| 23. | mobPhoneNoInvoice | String(12) | not required | Mobile phone number for bills. Contact details for informing about formed invoices and provided services. |
| 24. | telPhoneNoNetwork | String(12) | not required | Phone number for networks. Contact details for information on network work (accounting maintenance, electrical disconnections and faults). |
| 25. | emailNetwork | String(49) | not required | An email address for networks. Contact details for information on network work (accounting maintenance, electrical disconnections and faults). |
| 26. | email2Network | String(49) | not required | An email address 2 for networks. Contact details for information on network work (accounting maintenance, electrical disconnections and faults). |
| 27. | emailInvoice | String(100) | not required | An email address 2 for networks. Contact details for information on network work (accounting maintenance, electrical disconnections and faults). |
| objects[] | | | | |
| 28. | objectNumber | String(20) | required | Object number. |
| 29. | tariffPlan | String(200) | not required | Chosen tariff plan of the SBTS contract |
| 30. | contractModel | String(10) | required | Contract model of the current object. Possible meanings: |

| No. | Attribute | type | obligation | description |
|-----|---------------------|------------|--------------|--|
| | | | | BSS - General contract bills; 2S2S - Two contracts – Two bills. |
| 31. | timeZone | String(2) | not required | Current time zone of the object. Possible meanings: 1 - One; 2 - Two; VR - One with reactive; 4 - Four (Smart); DR - Differentiated with reactive. |
| 32. | payoffMethod | String(1) | not required | Chosen pay of method of the generating consumer. Possible meanings: <ul style="list-style-type: none"> • E – kWh – Recovered electricity; • G - kW – The power plant's permissible power; • P - % - Payment percentage; • S – kWh – PP recovered electricity. |
| 33. | objectNtr | String(20) | not required | Real estate cadaster and register number of the object of the State Enterprise Registers Center. |
| 34. | objectNtrDate | Date | not required | Date of the Real estate cadaster and register number of the object of the State Enterprise Register Center. |
| 35. | uniqueRoomNo | String(20) | not required | Unique room number. |
| 36. | ntGetCoownerConsent | Boolean | required | The feature or independent supplier has received the consent of the co-owners. Possible meanings: <ul style="list-style-type: none"> • True; • False |
| 37. | auctionDate | Date | not required | Date of acquisition of the object from the auction. |

7.5.2.2 JSON Response structure

The following table describes the JSON structure in the event of a response:

| No. | Attribute | type | obligation | description |
|-----|----------------|---------|------------|------------------|
| 1. | notificationId | Integer | required | Notification ID. |

7.5.2.3 Error Response structure

The following table describes the JSON structure in the event of a response error:

| No. | Attribute | type | obligation | description |
|-----|-----------|--------------|------------|----------------|
| 1. | code | number | required | Error code. |
| 2. | text | string(4000) | required | Error message. |

7.5.3 POST /gateway/notification/{notificationId}/contract/cancel

| | | | |
|---------------------------|--|---------------|--|
| URI | POST /gateway/notification/{notificationId}/contract/cancel | | |
| Description | The method is to cancel the change of contract owner / contract owner and supplier / supplier notification. | | |
| Parameters | URL: <i>notificationId</i> - message identifier. Mandatory. | | |
| Header | After encrypting the supplier authentication key, the supplier ID is used to verify that the supplier is revoking its message. | | |
| Request | POST request does not have the BODY part. | | |
| Response HTTP code | HTTP status code | Reason | Description |
| | 201 | Created | Request completed successfully. |
| | 400 | Bad Request | Request error. The HTTP response body provides a list of errors in JSON format. (<i>Error response of the JSON structure below</i>). |

| | | | | | |
|----------------------------|---|---|--|--|---|
| | 401 | Unauthorized | An attempt was made to connect to a non-public method that requires authentication, but no user credentials were provided. | | |
| | 403 | Forbidden | According to the access control policy, the current user does not have access to perform the requested action. | | |
| | 404 | Not Found | Either there is no API method associated with the request URL path, or the request contains one or more parameters that did not return the data. | | |
| Response | | | | | |
| JSON error response | <pre>{ "errorMessages": [{ "code": 0, "text": "string" }] }</pre> | | | | |
| Rules | No. | Rule description | Error code | Error message | Attributes |
| | 0. | If an attribute has defined possible values, the value index can be specified by specifying the value of the attribute in the request. Indices of all possible values start from 0. | - | - | All attributes with specified values. |
| | 1. | The request can be canceled: only one time; when the notification state is "Pateiktas"; | 50 | According to the given parameters, the message to be canceled could not be found / the cancellation deadline has | contract_change_status.status, contract_change_status.status.date |

| | | | | | |
|--|----|---|---|--|---|
| | | when the cancellation deadline has not passed (Initial value - 1 hour). | | expired / the message has already been canceled. | |
| | 2. | Upon successful cancellation of the owner / owner and supplier change request, the status of the request becomes "Atšauktas". | - | - | contract_change_status.status, contract_change_status.status.date |

7.5.3.1 Error Response structure

The following table describes the JSON structure in the event of a response error:

| No. | Attribute | type | obligation | description |
|-----|-----------|--------------|------------|----------------|
| 1. | code | number | required | Error code. |
| 2. | text | string(4000) | required | Error message. |

7.6 Notification contract termination controller

7.6.1 POST /gateway/notification/contract/termination/list?first={integer}&count={integer}&sortOrder={ASC/DSC}

| | |
|--------------------|---|
| URI | POST /gateway/notification/contract/termination/list?first={integer}&count={integer}&sortOrder={ASC/DSC} |
| Description | Method to obtain information of the contract termination. |
| Parameters | <p>URL:</p> <p>first - the index of the notification, which must be the first in the return list (starting from 0). Optional. The default value is 0.</p> |

| | | | |
|---------------------------|--|---------------|--|
| | <p>count - the number of notification rows in the return list. Optional. The default value is 30. sort - possible values ASC, DSC.</p> <p>The data of the JSON form request are presented in the HTTP request body (BODY) (Query JSON structure, below).</p> | | |
| Header | After decrypting the supplier authentication key, the supplier ID is used to select the data. | | |
| JSON request | <pre>{ "personCode": "string", "objectNumber": "string", "notificationId": "number", "contractTerminationDateFrom": "datetime", "contractTerminationDateTo": "datetime", "submittedDateFrom": "datetime", "submittedDateTo": "datetime", "status": "string", "contractTerminationReason": "string", "userNameSearch": "string" }</pre> | | |
| Response HTTP code | HTTP status code | Reason | Description |
| | 200 | OK | Request completed successfully |
| | 204 | No Content | No data found according to the given parameters. |
| | 400 | Bad Request | Request error. The HTTP response body provides a list of errors in JSON format. (<i>Error response of the JSON structure below</i>). |
| | 401 | Unauthorized | An attempt was made to connect to a non-public method that requires authentication, but no user credentials were provided. |
| | 403 | Forbidden | According to the access control policy, the current user does not have access to perform the requested action. |
| | 404 | Not Found | Either there is no API method associated with the request URL path, or the request contains one or more parameters that did not return the data. |
| JSON response | [| | |

```

{
  "notificationId":"number",
  "contractTerminationDate":"date",
  "contractTerminationReason":"string",
  "userName":"string",
  "submittedDate":"datetime",
  "latestStatus":"string",
  "errorType":"string",
  "objects":[
    {
      "personName":"string",
      "personSurname":"string",
      "personCode":"string",
      "consumerCode":"string",
      "objectNumber":"string",
      "objectAddress":"string",
      "contractType":"string",
      "contractModel":"string",
      "contractStart":"date",
      "coowner":"boolean",
      "coownerConsentDate":"date"
    }
  ],
  "contractTerminationNotificationStatus":[
    {
      "status":"string",
      "statusDate":"datetime"
    }
  ]
}
]

```

JSON error response

```

{
  "errorMessages": [

```

| | <pre> { "code": 0, "text": "string" }] } </pre> | | | | |
|-------|--|---|------------|--|---------------------------------------|
| Rules | No. | Rule description | Error code | Error message | Attributes |
| | 0. | If an attribute has defined possible values, the value index can be specified by specifying the value of the attribute in the request. Indices of all possible values start from 0. | - | - | All attributes with specified values. |
| | 1. | No data found according to the given parameters. | HTTP 204 | - | - |
| | 2. | One or more request parameters are required. | 1001 | One or more request parameters are required. | - |
| | 3. | DateFrom cannot be later than DateTo. Equal can be. | 1002 | DateFrom cannot be later than DateTo. | dateFrom |

7.6.1.1 JSON Request structure

The table below describes the structure of the JSON response:

| No. | Attribute | type | obligation | description |
|-----|-----------------------------|------------|--------------|---------------------------------|
| 1. | personCode | String(20) | not required | Person / company code. |
| 2. | objectNumber | String(20) | not required | Object number. |
| 3. | notificationId | Integer | not required | Notification ID. |
| 4. | contractTerminationDateFrom | DateTime | not required | Contract termination date from. |

| No. | Attribute | type | obligation | description |
|-----|---------------------------|-------------|--------------|--|
| 5. | contractTerminationDateTo | DateTime | not required | Contract termination date to. |
| 6. | submittedDateFrom | DateTime | not required | Submitted date from. |
| 7. | submittedDateTo | DateTime | not required | Submitted date to. |
| 8. | status | String(10) | not required | Notification status. Possible meanings: <ul style="list-style-type: none"> • P - Submitted • A – Cancelled • I – Sent • V - In progress • IV – Completed • K - Error. |
| 9. | contractTerminationReason | String(1) | not required | Contract termination reason. Possible meanings: <ul style="list-style-type: none"> • N - The termination of the contract between customer and the supplier; • P - The termination of the contract between customer and the supplier in cases of sale or termination / end of the lease; • L – Closure of the object in case of liquidation. • M – Termination due to death |
| 10. | userNameSearch | String(240) | not required | The user who created a notification. |

7.6.1.2 JSON Response structure

The table below describes the structure of the JSON response:

| No. | Attribute | type | obligation | description |
|-----|---------------------------------|------|------------|-------------|
| | contractTerminationNotification | | | |

| No. | Attribute | type | obligation | description |
|-----|---------------------------|-------------|--------------|--|
| 1. | notificationId | Integer | required | Notification ID |
| 2. | contractTerminationDate | Date | required | Date of the contract termination |
| 3. | contractTerminationReason | String(1) | required | Contract termination reason. Possible meanings: <ul style="list-style-type: none"> • N - The termination of the contract between customer and the supplier; • P - The termination of the contract between customer and the supplier in cases of sale or termination / end of the lease; • L – Closure of the object in case of liquidation. • M – Termination due to death |
| 4. | userName | String(240) | not required | The user who created the post. |
| 5. | submittedDate | DateTime | required | Submitted date of notification. |
| 6. | latestStatus | String(10) | required | Notification latest status. Possible meanings: <ul style="list-style-type: none"> • P - Submitted • A – Cancelled • I - Sent • V - In progress • IV – Completed • K - Error. |
| 7. | errorType | String(10) | not required | Notification error type if status=K (Error). Possible meanings: <ul style="list-style-type: none"> ▪ KT - Other works performed, the contract is not terminated, the object is not liquidated ▪ NL - Failed to access object, object not liquidated ▪ NP - The contract has already been terminated ▪ KL - Incorrect message ▪ NN - Termination is not possible because the data of the old contract does not match |

| No. | Attribute | type | obligation | description |
|-----------|---------------|--------------|--------------|--|
| | | | | <ul style="list-style-type: none"> ▪ NS - Termination is not possible, the contract will be terminated with a change of the owner / owner and supplier notification ▪ ND – It is not possible to carry out liquidation work ▪ NA - Termination not possible, owner has not been changed |
| objects[] | | | | |
| 8. | personName | String(200) | required | Contract owner / tenant name. |
| 9. | personSurname | String(50) | not required | Contract owner / tenant name surname. |
| 10. | personCode | String(20) | not required | Contract owner / tenant person / company code. |
| 11. | consumerCode | String(20) | required | Contract owner / tenant consumer code. |
| 12. | objectNumber | String(20) | required | Object number. |
| 13. | objectAddress | String(4000) | required | Object address. |
| 14. | contractType | String(10) | required | Contract type. Possible meanings: <ul style="list-style-type: none"> • SBTS - Household contract; • SKMS - Commercial contract. |
| 15. | contractModel | String(10) | required | Contract model of the current object. Possible meanings: <ul style="list-style-type: none"> • BSS - General contract bills; • 2S2S - Two contracts – Two bills. |
| 16. | contractStart | Date | required | Date of entry into force of the notification subject to the independent supplier from. |

| No. | Attribute | type | obligation | description |
|---------------------------------------|--------------------|------------|--------------|---|
| 17. | coowner | Boolean | not required | Indication that there is co-owner. |
| 18. | coownerConsentDate | Date | not required | Date of co-owner's consent. |
| contractTerminationNotificationStatus | | | | |
| 19. | status | String(10) | required | Notification status. Possible meanings: <ul style="list-style-type: none"> • P - Submitted • A – Cancelled • I - Sent • V - In progress • IV - Completed • K - Error. |
| 20. | statusDate | DateTime | required | Status date. |

7.6.1.3 Error Response structure

The following table describes the JSON structure in the event of a response error:

| No. | Attribute | type | obligation | description |
|-----|-----------|--------------|------------|----------------|
| 1. | code | number | required | Error code. |
| 2. | text | string(4000) | required | Error message. |

7.6.2 POST /gateway/notification/contract/termination

| | |
|--------------------|---|
| URI | POST /gateway/notification/contract/termination |
| Description | The method is for NT to transfer contract termination to DataHub. |
| Parameters | URL: |

| | | | |
|---------------------------|---|---------------|--|
| | The data of the JSON form request are presented in the HTTP request body (BODY) (Query JSON structure, below). | | |
| Header | After decrypting the supplier authentication key, the supplier ID is used to select the data. | | |
| JSON request | <pre>{ "contractTerminationDate":"date", "contractTerminationReason":"string", "consentSign":"boolean", "objects":[{ "objectNumber":"string", "coowner":"boolean", "coownerConsentDate":"date" }] }</pre> | | |
| Response HTTP code | HTTP status code | Reason | Description |
| | 201 | Created | Request completed successfully |
| | 400 | Bad Request | Request error. The HTTP response body provides a list of errors in JSON format. (<i>Error response of the JSON structure below</i>). |
| | 401 | Unauthorized | An attempt was made to connect to a non-public method that requires authentication, but no user credentials were provided. |
| | 403 | Forbidden | According to the access control policy, the current user does not have access to perform the requested action. |
| | 404 | Not Found | Either there is no API method associated with the request URL path, or the request contains one or more parameters that did not return the data. |

| | | | | | |
|----------------------------|---|---|-------------------|--|--|
| JSON response | <pre>{ "notificationId": "number" }</pre> | | | | |
| JSON error response | <pre>{ "errorMessages": [{ "code": 0, "text": "string" }] }</pre> | | | | |
| Rules | No. | Rule description | Error code | Error message | Attributes |
| | 0. | If an attribute has defined possible values, the value index can be specified by specifying the value of the attribute in the request. Indices of all possible values start from 0. | - | - | All attributes with specified values. |
| | 1. | Submitted object cannot have the same / matching meters numbers. | 76 | Contract termination not possible. Objects: [objectNumber (if there is more than one object, objects must be separated by the semicolon)] have the same / matching meter number. | object_meter.meter_number, object_meter.valid_from, object_meter.valid_to, object.object_number, object.object_id, objectNumber |
| | 2. | The attribute [ObjectNumber] is mandatory. | - | - | objectNumber |
| | 3. | The meaning of the [ObjectNumber] notification cannot be repeated. | 7 | The object: [objectNumber (if there is more than one object, objects must be separated by the semicolon)] is repeating.. | objectNumber |

| | | | | | |
|--|----|---|----|--|---|
| | 4. | Must be specified valid object. | 8 | The object: [objectNumber (if there is more than one object, objects must be separated by the semicolon)] not found in the system. | objectNumber |
| | 5. | The object must belong to a valid supplier contract that provides the notification. | 9 | The object: [objectNumber (if there is more than one object, objects must be separated by the semicolon)] does not belong to a valid supplier contract. | objectNumber, independentSupplierId, independent_supplier_objects.valid_from, independent_supplier_objects.valid_to, contract.conclusion_date |
| | 6. | The attribute [contractTerminationDate] format must be: yyyy-mm-dd. yyyy - year; mm - month; dd - day. | - | - | contractTerminationDate |
| | 7. | The attribute [contractTerminationReason] must be: <ul style="list-style-type: none"> ▪ N or ▪ P or ▪ L or ▪ M | - | - | contractTerminationReason |
| | 8. | Attributes [contractTerminationDate] and [contractTerminationReason] are mandatory. | - | - | contractTerminationDate, contractTerminationReason |
| | 9. | If the attribute [contractTerminationReason] =N, then the attribute [contractTerminationDate] must be: | 70 | Date of the contract termination [contractTerminationDate] must be equal to the last date of a current month, if the request was made until a current month [config day] | contractTerminationDate |

| | | | | |
|-----|---|----|---|---|
| | <ul style="list-style-type: none"> the last date of the current month, if the request was made until the config month day (initial value =18); the last date of the next month, if the request was made after the config month day (initial value =18). | | day, or must be equal to the last date of a next month, if the request was made after a current month [config date] day. | |
| 10. | <p>If the attribute [contractTerminationreason]=P, then the attribute [contractTerminationDate] can be equal to the current date or later. Ex.: If the current date is 2021-02-08 , then [contractTerminationDate] start date can be any date from 2021-02-08 to X day to the future.</p> | 71 | Date of the contract termination [contractTerminationDate] can be equal to the current date or later. | contractTerminationDate |
| 11. | <p>If the attribute [contractTerminationreason]=L or attribute [contractTerminationreason]=M, then the attribute [contractTerminationDate] must be equal to the current date .</p> | 72 | Date of the contract termination [contractTerminationDate] must be equal to the current date. | contractTerminationDate |
| 12. | <p>Date of the contract termination cannot be equal to date of contract start.</p> | 73 | Date of the contract termination [contractTerminationDate] cannot be equal to objects [objectNumber (if there is more than one object, | objectNumber, contract_object.valid_from, independent_supplier_object.valid_from, contractTerminationDate |

| | | | | | |
|-----|--|------|---|---|--|
| | | | | objects must be separated by the semicolon] contract start date. | |
| 13. | The contract cannot be terminated for the object if the termination has already been submitted / in progress/ completed / sent. | 74 | The contract cannot be terminated for the object [objectNumber (if there is more than one object, objects must be separated by the semicolon)] because the termination of the contract has already been submitted. | objectNumber, contract_termination_notification.object_number, contract_termination_notification_object.contract_object_id, contract_termination_notification_status | |
| 14. | The meaning of the [consentSign] must be: <ul style="list-style-type: none"> ▪ True or ▪ False. | - | - | consentSign | |
| 15. | If the attribute [consentSign] = False , then the contract termination must be disabled. | 32 | It is necessary to confirm that the data provided is correct. | consentSign | |
| 16. | Upon successful creation of a contract termination request, the status of the request becomes "Submitted". | - | - | contract_termination_notification_status.status, contract_termination_notification_status.status_date | |
| 17. | The supplier will be identified by the authentication key. | 1003 | The independent supplier cannot be found in the system or supplier is not active. | independent_supplier.id, contract_termination_notification.independent_supplier_id | |
| 18. | All objects of the notification must belong to the same contract. | 43 | Change not possible. Different contracts for submitted objects. | objectNumber, consumerCode | |

| | | | | | |
|--|-----|--|-----|--|---|
| | 19. | Date of the contract termination cannot be later than the date of contract end. | 120 | Date of the contract termination [contractTerminationDate] cannot be later than objects [objectNumber (if there is more than one object, objects must be separated by the semicolon)] the date of contract end. | objectNumber, contract_object.valid_to, independent_supplier_object.valid_to, contractTerminationDate |
| | 20. | If [contractTerminationReason] =L, then one of the fields is required: <ul style="list-style-type: none"> • coowner or • coownerConsentDate An error occurs when neither is not specified. | 121 | If contract termination reason is "Closure of the object in case of liquidation", then one of the attributes is required "No co-owner" or "Co-owner consent date". | contractTerminationReason, coowner, coownerConsentDate |
| | 21. | If [contractTerminationReason] is not equal L, then the fields must not be specified: <ul style="list-style-type: none"> • coowner • coownerConsentDate | 122 | If contract termination reason is not "Closure of the object in case of liquidation", then attributes "No co-owner", "Co-owner consent date" must not be specified. | contractTerminationReason, coowner, coownerConsentDate |
| | 22. | Values of attribute [coowner] must be: <ul style="list-style-type: none"> ▪ True ▪ False | - | - | coowner |
| | 23. | The format of attribute [coownerConsentDate] must be yyyy-mm-dd. | - | - | coownerConsentDate |

| | | | | | |
|--|-----|---|-----|---|---|
| | 24. | If the field [ntGetCoownerConsent] is specified, the field [coownerConsentDate] must be specified. | 124 | If the attribute "NT get co-owner consent" is specified, then must be specified "Co-owner consent date". | ntGetCoownerConsent, coownerConsentDate |
| | 25. | If the field [ntGetCoownerConsent] is not specified, the field [coownerConsentDate] must be not specified. | 125 | If the attribute "NT get co-owner consent" is not specified, then must be not specified "Co-owner consent date". | ntGetCoownerConsent, coownerConsentDate |
| | 26. | If [contractTerminationReason] =L or P or M, then it can be filed only one object for one termination of contract request. | 127 | If contract termination reason is "Closure of the object in case of liquidation" or "The termination of the contract between customer and the supplier in cases of sale or termination / end of the lease" or "Termination due to death", then it can be filed only one object for one termination of contract request. | contractTerminationReason, objectNumber |
| | 27. | If the field [coowner]=TRUE, the field [coownerConsentDate] must be specified. If the field [coowner]=FALSE, the field [coownerConsentDate] must be not specified. | 128 | If there is a co-owner, the date of the co-owner's consent must be indicated. If there is not a co-owner, the date of consent is not indicated. | coowner, coownerConsentDate |

7.6.2.1 JSON Request structure

The table below describes the structure of the JSON request:

| No. | Attribute | type | obligation | description |
|-----|--------------------------------|--------------------|-------------------------|--|
| 1. | contractTerminationDate | Date | required | Date of contract termination. |
| 2. | contractTerminationReason | String(1) | required | Contract termination reason. Possible meanings: <ul style="list-style-type: none"> • N - The termination of the contract between customer and the supplier; • P - The termination of the contract between customer and the supplier in cases of sale or termination / end of the lease; • L – Closure of the object in case of liquidation • M - Termination due to death. |
| 3. | consentSign | Boolean | required | Indication of whether the data provided by the contract owner / owner and supplier are correct. Possible meanings: <ul style="list-style-type: none"> • True; • False. |
| | objects:[] | | | |
| 4. | objectNumber | String | required | Object number. |
| 5. | coowner | Boolean | not required | Indication that there is co-owner. |
| 6. | ntGetCoownerConsent | Boolean | not required | Indication of whether the independent supplier has obtained the consent of the co-owner. |
| 7. | coownerConsentDate | Date | not required | Date of co-owner's consent. |

7.6.2.2 JSON Response structure

The following table describes the JSON structure in the event of a response:

| No. | Attribute | type | obligation | description |
|-----|----------------|---------|------------|------------------|
| 1. | notificationId | Integer | required | Notification ID. |

7.6.2.3 Error Response structure

The following table describes the JSON structure in the event of a response error:

| No. | Attribute | type | obligation | description |
|-----|-----------|--------------|------------|----------------|
| 1. | code | number | required | Error code. |
| 2. | text | string(4000) | required | Error message. |

7.6.3 POST /gateway/notification/{notificationId}/contract/termination/cancel

| | | | |
|---------------------------|--|---------------|--|
| URI | POST /gateway/notification/{notificationId}/contract/termination/cancel | | |
| Description | The method is to cancel the contract termination notification. | | |
| Parameters | URL: <ul style="list-style-type: none"> notificationId – message identifier. Mandatory. | | |
| Header | After encrypting the supplier authentication key, the supplier ID is used to verify that the supplier is revoking its message. | | |
| Request | POST request does not have the BODY part. | | |
| Response HTTP code | HTTP status code | Reason | Description |
| | 201 | Created | Request completed successfully. |
| | 400 | Bad Request | Request error. The HTTP response body provides a list of errors in JSON format. (<i>Error response of the JSON structure below</i>). |

| | | | | | |
|----------------------------|---|---|--|---|---|
| | 401 | Unauthorized | An attempt was made to connect to a non-public method that requires authentication, but no user credentials were provided. | | |
| | 403 | Forbidden | According to the access control policy, the current user does not have access to perform the requested action. | | |
| | 404 | Not Found | Either there is no API method associated with the request URL path, or the request contains one or more parameters that did not return the data. | | |
| Response | | | | | |
| JSON error response | <pre>{ "errorMessages": [{ "code": 0, "text": "string" }] }</pre> | | | | |
| Rules | No. | Rule description | Error code | Error message | Attributes |
| | 0. | If an attribute has defined possible values, the value index can be specified by specifying the value of the attribute in the request. Indices of all possible values start from 0. | - | - | All attributes with specified values. |
| | 1. | <p>The request can be canceled:</p> <ul style="list-style-type: none"> • only one time; • when the notification state is "Pateiktas"; | 50 | According to the given parameters, the message to be canceled could not be found / the cancellation deadline has expired / the message has already been canceled. | contract_termination_notification_status.status, contract_termination_notification_status.status.date |

| | | | | | |
|--|----|---|---|---|---|
| | | <ul style="list-style-type: none"> when the cancellation deadline has not passed (Initial value - 1 hour). | | | |
| | 2. | Upon successful cancellation of the contract termination request, the status of the request becomes "Atšauktas". | - | - | contract_termination_notification_status.status, contract_termination_notification_status.status.date |

7.6.3.1 Error Response structure

The following table describes the JSON structure in the event of a response error:

| No. | Attribute | type | obligation | description |
|-----|-----------|--------------|------------|----------------|
| 1. | code | number | required | Error code. |
| 2. | text | string(4000) | required | Error message. |

7.7 Notification contract object supply state controller

7.7.1 POST /gateway/notification/contract/object/supply-state/list?first={integer}&count={integer}&sortOrder={ASC/DSC}

| | |
|--------------------|--|
| URI | POST /gateway/notification/contract/object/supply-state/list?first={integer}&count={integer}&sortOrder={ASC/DSC} |
| Description | The method is to obtain a list of object's disconnection/connection. |
| Parameters | <p>URL:</p> <p>first - the index of the notification, which must be the first in the return list (starting from 0). Optional. The default value is 0.</p> <p>count - the number of notification rows in the return list. Optional. The default value is 30.</p> |

| | | | |
|---------------------------|---|---------------|--|
| | <p>sort - possible values ASC, DSC.</p> <ul style="list-style-type: none"> • By default, the list should be sorted by the "notificationId" - the latest request records should be displayed at the top of the list; • Must be able to sort list entries by all list fields except status history; <p>The data of the JSON form request are presented in the HTTP request body (BODY) (Query JSON structure, below).</p> | | |
| Header | After decrypting the supplier authentication key, the supplier ID is used to select the data. | | |
| JSON request | <pre>{ "notificationId":"number", "personCode":"string", "consumerCode":"string", "objectNumber":"string", "objectAddressSearch":"string", "changeType":["string"], "status":["string"], "submittedDateFrom":"datetime", "submittedDateTo":"datetime", "contractType":"string", "contractModel":"string", "userNameSearch":"string" }</pre> | | |
| Response HTTP code | HTTP status code | Reason | Description |
| | 200 | OK | Request completed successfully |
| | 204 | No Content | No data found according to the given parameters. |
| | 400 | Bad Request | Request error. The HTTP response body provides a list of errors in JSON format. (<i>Error response of the JSON structure below</i>). |
| | 401 | Unauthorized | An attempt was made to connect to a non-public method that requires authentication, but no user credentials were provided. |

| | | | |
|--|-----|-----------|--|
| | 403 | Forbidden | According to the access control policy, the current user does not have access to perform the requested action. |
| | 404 | Not Found | Either there is no API method associated with the request URL path, or the request contains one or more parameters that did not return the data. |

JSON response

```
[
  {
    "notificationId":"number",
    "changeType":"string",
    "notes":"string",
    "submittedDate":"datetime",
    "latestStatus":"string",
    "errorType":"string",
    "userName":"string",
    "currentObjectData":{
      "objectNumber":"string",
      "objectAddress":"string",
      "personName":"string",
      "personSurname":"string",
      "personCode":"string",
      "consumerCode":"string",
      "contractType":"string",
      "contractModel":"string",
      "objectSupplyState":"string",
      "objectSupplyStateValidFrom":"date",
      "objectSupplyStateValidTo":"date",
      "sociallyVulnerable":"boolean"
    },
    "supplyStateNotificationStatus":[
      {
        "status":"string",
        "statusDate":"datetime"
      }
    ]
  }
]
```

| | | | | | |
|----------------------------|---|---|-------------------|--|--|
| | <pre>] }] </pre> | | | | |
| JSON error response | <pre> { "errorMessages": [{ "code": 0, "text": "string" }] } </pre> | | | | |
| Rules | No. | Rule description | Error code | Error message | Attributes |
| | 0. | If an attribute has defined possible values, the value index can be specified by specifying the value of the attribute in the request. Indices of all possible values start from 0. | - | - | All attributes with specified values. |
| | 1. | No data found according to the given parameters. | HTTP 204 | - | - |
| | 2. | One or more request parameters are required. | 1001 | One or more request parameters are required. | - |
| | 3. | DateFrom cannot be later than DateTo. Equal can be. | 1002 | DateFrom cannot be later than DateTo. | submittedDateFrom, contractTerminationDateFrom |

7.7.1.1 JSON Request structure

The table below describes the structure of the JSON request:

| No. | Attribute | type | obligation | Description |
|-----|---------------------|--------------|--------------|---|
| 1. | notificationId | Integer | not required | Disconnection/connection notification ID. |
| 2. | personCode | String(20) | not required | Contract owner / tenant person / company code. |
| 3. | consumerCode | String(20) | not required | Contract owner / tenant consumer code. |
| 4. | objectNumber | String(20) | not required | Object number. |
| 5. | objectAddressSearch | String(4000) | not required | Object address. The search by the fragment. |
| 6. | changeType | ["string"] | not required | <p>Disconnection/connection change type. Possible meanings:</p> <ul style="list-style-type: none"> • D – Disconnection at the request of the consumer; • DD – Disconnection due to the debt; • C – Connection of the consumer; • CD – Connection of the consumer after payment of the debt. <p>More than one exchange type can be selected.</p> |
| 7. | status | String(20) | not required | <p>Notification newest status. Possible meanings:</p> <ul style="list-style-type: none"> • P - Submitted • A - Cancelled • I - Sent • V – In progress • IV - Completed • K - Error <p>More than one exchange type can be selected.</p> |
| 8. | submittedDateFrom | DateTime | not required | <ul style="list-style-type: none"> • The submission date from of the notification. • Format: yyyy-mm-dd |
| 9. | submittedDateTo | DateTime | not required | <ul style="list-style-type: none"> • The summation date to of the notification. • Format: yyyy-mm-dd |
| 10. | contractType | String(20) | not required | Contract type of the current object. Possible meanings: |

| No. | Attribute | type | obligation | Description |
|-----|----------------|-------------|--------------|---|
| | | | | <ul style="list-style-type: none"> • SBTS - Household customer; • SKMS - Commercial customer. |
| 11. | contractModel | String(10) | not required | Contract model of the current object. Possible meanings: <ul style="list-style-type: none"> • BSS - General contract bills; • 2S2S - Two contracts – Two bills. |
| 12. | userNameSearch | String(240) | not required | The user who created a notification. Search by the fragment. |

7.7.1.2 JSON Response structure

The table below describes the structure of the JSON response:

| No. | Attribute | type | obligation | description |
|-----|----------------|--------------|--------------|--|
| 1. | notificationId | Integer | required | Disconnection/connection notification ID. |
| 1. | changeType | String(3) | required | Disconnection/connection change type. Possible meanings: <ul style="list-style-type: none"> • D – Disconnection at the request of the consumer; • DD – Disconnection due to the debt; • C – Connection of the consumer; • CD – Connection of the consumer after payment of the debt. |
| 2. | notes | String(4000) | not required | Notification notes. |
| 3. | submittedDate | DateTime | required | The submission date of the notification. |
| 5. | latestStatus | String(20) | required | Notification newest status. Possible meanings: <ul style="list-style-type: none"> • P - Submitted • A - Cancelled • I - Sent • V – In progress • IV - Completed |

| No. | Attribute | type | obligation | description |
|-----------------------|---------------|--------------|--------------|---|
| | | | | <ul style="list-style-type: none"> K - Error |
| 6. | errorType | String(10) | not required | Notification error type if status=K (Error). Possible meanings: <ul style="list-style-type: none"> KL - Incorrect message OT – The object has no accounting point BA – Supply state cannot be changed because the data of the old contract does not match KD - Other works completed AD - Unable to perform user on/off operations NB - The facility could not be accessed |
| 7. | userName | String(240) | not required | The user who created a notification |
| currentObjectData: {} | | | | |
| 8. | objectNumber | String(20) | required | Object number. |
| 9. | objectAddress | String(4000) | required | Object address. |
| 10. | personName | String(200) | required | Contract owner / tenant / company name. |
| 11. | personSurname | String(50) | not required | Contract owner / tenant surname. |
| 12. | personCode | String(20) | not required | Person / tenant / company code. If the subject is an individual than person code must be returned encrypted: [*****][the last 3 symbols of the person code] |
| 13. | consumerCode | String(20) | required | Contract owner / tenant consumer code. |
| 14. | contractType | String(10) | required | Contract type of the current object. Possible meanings: <ul style="list-style-type: none"> SBTS - Household customer; SKMS - Commercial customer. |
| 15. | contractModel | String(10) | required | Contract model of the current object. Possible meanings: <ul style="list-style-type: none"> BSS - General contract bills; |

| No. | Attribute | type | obligation | description |
|----------------------------------|----------------------------|------------|--------------|--|
| | | | | <ul style="list-style-type: none"> 2S2S - Two contracts – Two bills. |
| 16. | objectSupplyState | String(3) | not required | Contract object's electricity supply state. Possible meanings: T - Supply; P – Disconnected on request ; A - Disconnected under sanction; R – Limited by sanction. |
| 17. | objectSupplyStateValidFrom | Date | not required | The object's electricity supply status is valid from. |
| 18. | objectSupplyStateValidTo | Date | not required | The object's electricity supply status is valid to. |
| 19. | sociallyVulnerable | Boolean | required | An indication of whether the owner/tenant of the object is socially vulnerable. |
| supplyStateNotificationStatus:[] | | | | |
| 20. | status | String(10) | required | Notification all status. Possible meanings: <ul style="list-style-type: none"> P - Submitted A - Cancelled I - Sent V – In progress IV - Completed K - Error |
| 21. | statusDate | DateTime | required | Date of the status. |

7.7.1.3 Error Response structure

The following table describes the JSON structure in the event of a response error:

| No. | Attribute | type | obligation | description |
|-----|-----------|--------|------------|-------------|
| 1. | code | number | required | Error code. |

| No. | Attribute | type | obligation | description |
|-----|-----------|--------------|------------|----------------|
| 2. | text | string(4000) | required | Error message. |

7.7.2 POST /gateway/notification/contract/object/supply-state

| | | | |
|---------------------------|--|---------------|--|
| URI | POST /gateway/notification/contract/object/supply-state | | |
| Description | The method is for independent supplier to transfer object's disconnection/connection (supply state change) to DataHub. | | |
| Parameters | URL: The data of the JSON form request are presented in the HTTP request body (BODY) (Query JSON structure, below). | | |
| Header | After decrypting the supplier authentication key, the supplier ID is used to select the data. | | |
| JSON request | <pre>{ "changeType": "string", "notes": "string", "consentSign": "boolean", "objectNumber": "string" }</pre> | | |
| Response HTTP code | HTTP status code | Reason | Description |
| | 201 | Created | Request completed successfully |
| | 400 | Bad Request | Request error. The HTTP response body provides a list of errors in JSON format. (<i>Error response of the JSON structure below</i>). |
| | 401 | Unauthorized | An attempt was made to connect to a non-public method that requires authentication, but no user credentials were provided. |
| | 403 | Forbidden | According to the access control policy, the current user does not have access to perform the requested action. |

| | | | | | |
|----------------------------|--|---|--|---|---|
| | 404 | Not Found | Either there is no API method associated with the request URL path, or the request contains one or more parameters that did not return the data. | | |
| JSON response | <pre>{ "notificationId": "number" }</pre> | | | | |
| JSON error response | <pre>{ "errorMessages": [{ "code": 0, "text": "string" }] }</pre> | | | | |
| Rules | No. | Rule description | Error code | Error message | Attributes |
| | * Date type fields can be filled with time where it should not be according to the rules below. The time will be clipped automatically and the date will be stored without time. | | | | |
| | 0. | If an attribute has defined possible values, the value index can be specified by specifying the value of the attribute in the request. Indices of all possible values start from 0. | - | - | All attributes with specified values. |
| | 1. | The supplier will be identified by the authentication key. | 1003 | The independent supplier cannot be found in the system or supplier is not active. | independent_supplier.id, contract_termination_notification, independent_supplier_id |
| | 2. | The attribute [ObjectNumber] is mandatory. | - | - | objectNumber |
| 3. | Must be specified valid object. | 1 | Change not possible. The object: [objectNumber] does not found in the system. | objectNumber | |

| | | | | |
|-----|--|---|---|---|
| 4. | The object must belong to a valid supplier contract that provides the notification. | 2 | Change not possible. The object: [objectNumber] does not belong to a valid supplier contract. | objectNumber, independentSupplierId, independent_supplier_objects.valid_from, independent_supplier_objects.valid_to, contract.conclusion_date |
| 5. | If the object does not have a valid electricity supply status for the current date, the change is not possible. | 3 | Change not possible. The object [objectNumber] does not have a valid electricity energy supply status. | objectNumber, object_state.state_type |
| 6. | The attribute [changeType] must be: <ul style="list-style-type: none"> • D or • DD or • C or • CD. | - | - | - |
| 7. | The attribute [changeType] is mandatory. | - | - | changeType |
| 8. | The attribute [changeType] must be = D / DD if the current electricity energy supply state of the object = T - Supply. | 4 | Change not possible. Object: [objectNumber] current electricity energy supply state is "Supply". Possible change type: "Disconnection at the request of the consumer" or "Disconnection due to the debt". | objectNumber, changeType |
| 9. | The attribute [changeType] must be = C if the current electricity energy supply state of the object = P - Disconnected on request. | 5 | Change not possible. Object: [objectNumber] current electricity energy supply state is "Disconnected on request". Possible change type: "Connection of the consumer". | objectNumber, changeType |
| 10. | The attribute [changeType] must be = CD if the current | 6 | Change not possible. Object: [objectNumber] current electricity energy supply state | objectNumber, changeType |

| | | | | |
|-----|--|----|--|---|
| | electricity energy supply state of the object = A - Disconnected under sanction / R - Limited by sanction. | | is "Disconnected under sanction" or "Limited by sanction". Possible change type: "Connection of the consumer after payment of the debt". | |
| 11. | When submitting a new notification, it must be checked whether the system already has a notification with the status =In Progress / Sent / Submitted and whose objectNumber, changeType matches the objectNumber, changeType of the newly submitted notification. If such a notification is found, the change is not possible. | 7 | Change not possible. The notification has already been submitted to [objectNumber]. | objectNumber, changeType |
| 12. | The meaning of the [consentSign] must be: <ul style="list-style-type: none"> • True or • False. | - | - | consentSign |
| 13. | If the attribute [consentSign] = False, then the contract termination must be disabled. | 32 | It is necessary to confirm that the data provided is correct. | consentSign |
| 14. | Upon successful creation of a supply state notification, the status of the notification becomes "Submitted". | - | - | supply_state_notification, supply_state_notification_status |

7.7.2.1 JSON Request structure

The table below describes the structure of the JSON request:

| No. | Attribute | type | obligation | Description |
|-----|--------------|--------------|--------------|---|
| 1. | changeType | String(3) | required | <p>Disconnection/connection change type. Possible meanings:</p> <ul style="list-style-type: none"> • D – Disconnection at the request of the consumer; • DD – Disconnection due to the debt; • C – Connection of the consumer; • CD – Connection of the consumer after payment of the debt. <p>More than one exchange type can be selected.</p> |
| 2. | notes | String(4000) | not required | Notification notes. |
| 3. | consentSign | Boolean | required | <p>The consent sign of the notification. Possible meanings:</p> <ul style="list-style-type: none"> • True or • False. |
| 4. | objectNumber | String(20) | required | Object number. |

7.7.2.2 JSON Response structure

The table below describes the structure of the JSON response:

| No. | Attribute | type | obligation | description |
|-----|----------------|---------|------------|---|
| 1. | notificationId | Integer | required | Disconnection/connection notification ID. |

7.7.2.3 Error Response structure

The following table describes the JSON structure in the event of a response error:

| No. | Attribute | type | obligation | description |
|-----|-----------|--------------|------------|----------------|
| 1. | code | number | required | Error code. |
| 2. | text | string(4000) | required | Error message. |

7.7.3 POST /gateway/notification/{notificationId}/contract/object/supply-state/cancel

| | | | |
|----------------------------|---|---------------|--|
| URI | POST /gateway/notification/{notificationId}/contract/object/supply-state/cancel | | |
| Description | The method is to cancel the disconnection/connection notification. | | |
| Parameters | URL: <i>notificationId</i> – message identifier. Mandatory. | | |
| Header | After decrypting the supplier authentication key, the supplier ID is used to select the data. | | |
| JSON request | POST request does not have the BODY part. | | |
| Response HTTP code | HTTP status code | Reason | Description |
| | 201 | OK | Request completed successfully. |
| | 400 | Bad Request | Request error. The HTTP response body provides a list of errors in JSON format. (<i>Error response of the JSON structure below</i>). |
| | 401 | Unauthorized | An attempt was made to connect to a non-public method that requires authentication, but no user credentials were provided. |
| | 403 | Forbidden | According to the access control policy, the current user does not have access to perform the requested action. |
| | 404 | Not Found | Either there is no API method associated with the request URL path, or the request contains one or more parameters that did not return the data. |
| JSON response | | | |
| JSON error response | <pre>{ "errorMessages": [{</pre> | | |

```

"code": 0,
"text": "string"
}
]
}

```

| Rules | No. | Rule description | Error code | Error message | Attributes |
|-------|-----|---|------------|---|---|
| | 0. | If an attribute has defined possible values, the value index can be specified by specifying the value of the attribute in the request. Indices of all possible values start from 0. | - | - | All attributes with specified values. |
| | 1. | The request can be canceled: <ul style="list-style-type: none"> • only one time; • when the notification state is "Pateiktas"; • when the cancellation deadline has not passed (Initial value - 1 hour). | 50 | According to the given parameters, the message to be canceled could not be found / the cancellation deadline has expired / the message has already been canceled. | supply_state_notification_status.status, supply_state_notification_status.status.date |
| | 2. | Upon successful cancellation, the status of the notification | - | - | supply_state_notification_status.status, supply_state_notification_status.status.date |

| | | | | | |
|--|--|-------------------------|--|--|--|
| | | becomes "Atšauktas". | | | |
|--|--|-------------------------|--|--|--|

7.7.3.1 Error Response structure

The following table describes the JSON structure in the event of a response error:

| No. | Attribute | type | obligation | description |
|-----|-----------|--------------|------------|----------------|
| 1. | code | number | required | Error code. |
| 2. | text | string(4000) | required | Error message. |

7.8 Notification cancellation controller

7.8.1 POST /gateway/notification/cancellation/list?first={integer}&count={integer}&sortOrder={ASC/DSC}

| | |
|--------------------|--|
| URI | POST /gateway/notification/cancellation/list?first={integer}&count={integer}&sortOrder={ASC/DSC} |
| Description | The method is designed to obtain notification cancelation request for NTK |
| Parameters | <p>URL:</p> <ul style="list-style-type: none"> • first - index (starting from 0) of the notification that must be presented first in the return list. Optional. The default value is 0. • count - number of notification in the return list. Optional. The default value is 30. • sort - possible values ASC, DSC. <ul style="list-style-type: none"> • By default, the list must be sorted by the column "notificationId". The most recent request records must be displayed at the top of the list; • It shall be possible to sort the list entries by all fields in the list, except status history; <p>The data of the JSON form request are presented in the HTTP request body (BODY) (Query JSON structure, below).</p> |
| Header | After decrypting the supplier authentication key, the supplier ID is used to select the data. |

| | | | |
|---------------------------|--|---------------|--|
| JSON request | <pre>{ "notificationId": "number", "cancelledNotificationId": "number", "cancelledNotificationType": ["string"], "objectNumber": "string", "objectAddressSearch": "string", "submittedDateFrom": "datetime", "submittedDateTo": "datetime", "status": ["string"], "userNameSearch": "string" }</pre> | | |
| Response HTTP code | HTTP status code | Reason | Description |
| | 200 | OK | Request completed successfully |
| | 204 | No Content | No data found according to the given parameters. |
| | 400 | Bad Request | Request error. The HTTP response body provides a list of errors in JSON format. (<i>Error response of the JSON structure below</i>). |
| | 401 | Unauthorized | An attempt was made to connect to a non-public method that requires authentication, but no user credentials were provided. |
| | 404 | Not Found | Either there is no API method associated with the request URL path, or the request contains one or more parameters that did not return the data. |
| JSON response | <pre>[{ "notificationId": "number", "cancelledNotificationId": "number", "cancelledNotificationType": "string",</pre> | | |

| | | | | | |
|----------------------------|--|---|-------------------|--|-------------------|
| | <pre> "cancelledFullNotification":"boolean", "userName":"string", "submittedDate":"datetime", "latestStatus":"string", "errorType":"string", "objects":[{ "objectNumber":"string", "objectAddress":"string" }], "notificationStatus":[{ "status":"string", "statusDate":"datetime" }] }] </pre> | | | | |
| JSON error response | <pre> { "errorMessages": [{ "code": 0, "text": "string" }] } </pre> | | | | |
| Rules | No. | Rule description | Error code | Error message | Attributes |
| | 0. | If an attribute has defined possible values, the value index can be specified by specifying the value of the attribute in the request. Indices of all possible values start from 0. | - | - | - |
| | 1. | No data found according to the given parameters. | HTTP 204 | - | - |
| | 2. | One or more request parameters are required. | 1001 | One or more request parameters are required. | - |

| | | | | | |
|--|----|---|------|--|-------------------|
| | 3. | DateFrom cannot be later than DateTo. Equal can be. | 1002 | One or more request parameters are required. | submittedDateFrom |
|--|----|---|------|--|-------------------|

7.8.1.1 JSON Request structure

The table below describes the structure of the JSON request:

| No. | Attribute | type | obligation | description |
|-----|---------------------------|--------------|--------------|--|
| 1. | notificationId | Integer | not required | Request identifier. Search is possible by full value |
| 2. | cancelledNotificationId | Integer | not required | Identifier of the cancelation request. Search is possible by full value |
| 3. | cancelledNotificationType | String:[] | not required | <p>Cancelation request type. Possible values:</p> <ul style="list-style-type: none"> • STK - owner and supplier change • NTK - supplier change • SK - owner change • SN - termination of contract • KT - change of contacts • TPK - Change of tariff plans • AP - Disconnect / connect <p>More then one type can be submitted</p> |
| 4. | objectNumber | String(20) | not required | Object number. Search is possible by full value |
| 5. | objectAddressSearch | String(4000) | not required | Object address. Search by the fragment. |
| 6. | submittedDateFrom | DateTime | not required | Date of submission "from". |
| 7. | submittedDateTo | DateTime | not required | Date of submission "to". |
| 8. | status | String:[] | not required | <p>Message status. The possible values are:</p> <ul style="list-style-type: none"> • P – Submitted • A – Cancelled • I – Sent • V - In progress • IV - Completed • K - Error |

| No. | Attribute | type | obligation | description |
|-----|----------------|-------------|--------------|--------------------------------------|
| | | | | More then one type can be submitted. |
| 9. | userNameSearch | String(240) | not required | Search by fragment |

7.8.1.2 JSON Response structure

The table below describes the structure of the JSON response:

| No. | Attribute | type | obligation | description |
|-----|---------------------------|-------------|--------------|--|
| 1. | notificationId | Integer | required | Request identifier. |
| 2. | cancelledNotificationId | Integer | required | Identifier of the cancelation request. |
| 3. | cancelledNotificationType | String(10) | required | Cancelation request type. Possible values are: <ul style="list-style-type: none"> • STK - owner and supplier change • NTK - supplier change • SK - owner change • SN - termination of contract • KT - change of contacts • TPK - Change of tariff plans • AP - Disconnect / connect |
| | cancelledFullNotification | Boolean | required | Attribute indicating whether all objects are canceled with cancelation request. If all – then response “YES”, if no – the response “No”. |
| 4. | userName | String(240) | not required | User, that created entry |
| 5. | submittedDate | DateTime | required | Date of notification |
| 6. | latestStatus | String(10) | required | Latest status of message. The possible values are: <ul style="list-style-type: none"> • P – Submitted • A – Cancelled • I – Sent • V - In progress |

| No. | Attribute | type | obligation | description |
|-----------------------|---------------|--------------|--------------|---|
| | | | | <ul style="list-style-type: none"> • IV – Completed • K - Error |
| 7. | errorType | String(10) | not required | <p>Responde in case of error. The value is returned only if the status is "K – Error"</p> <p>Possible meanings are:</p> <ul style="list-style-type: none"> • KL - Incorrect message • AT - Cancellation of a supplier is not possible because the object has already entered into NT • AN - Supplier cancellation is not possible because the object in the NT does not match the Billing data • AS - Cancellation of a supplier is not possible because the details of the old contract do not match |
| objects:[] | | | | |
| 8. | objectNumber | String(20) | not required | Object number |
| 9. | objectAddress | String(4000) | not required | Object address |
| notificationStatus:[] | | | | |
| 10. | status | String(10) | required | <p>Message status. The possible values are:</p> <ul style="list-style-type: none"> • P – Submitted • A – Cancelled • I – Sent • V - In progress • IV – Completed • K -Error |
| 11. | statusDate | DateTime | required | Status date |

7.8.1.3 Error Response structure

The following table describes the JSON structure in the event of a response error:

| No. | Attribute | type | obligation | description |
|-----|-----------|--------------|------------|----------------|
| 1. | code | number | required | Error code. |
| 2. | text | string(4000) | required | Error message. |

7.8.2 POST /gateway/notification/cancellation

| | | | |
|---------------------------|--|---------------|--|
| URI | POST /gateway/notification/cancellation | | |
| Description | The method is designed to transfer cancelation request to DataHub for NTK | | |
| Parameters | URL: The data of the JSON form request are presented in the HTTP request body (BODY) (Query JSON structure, below). | | |
| Header | After decrypting the supplier authentication key, the supplier ID is used to save the data. | | |
| JSON request | <pre>{ "cancelledNotificationId": "number", "cancelledNotificationType": "string", "consentSign": "boolean", "objectNumbers": ["string"] }</pre> | | |
| Response HTTP code | HT TP stat us code | Reason | Description |
| | 201 | Created | Request completed successfully |
| | 400 | Bad Request | Request error. The HTTP response body provides a list of errors in JSON format. (<i>Error response of the JSON structure below</i>). |

| | | | | | |
|----------------------------|---|---|--|---|---|
| | 401 | Unauthorized | An attempt was made to connect to a non-public method that requires authentication, but no user credentials were provided. | | |
| | 403 | Forbidden | According to the access control policy, the current user does not have access to perform the requested action. | | |
| | 404 | Not Found | Either there is no API method associated with the request URL path, or the request contains one or more parameters that did not return the data. | | |
| JSON response | <pre>{ „notificationId“: „number“ }</pre> | | | | |
| JSON error response | <pre>{ „errorMessages“: [{ „code“: 0, „text“: „string“ }] }</pre> | | | | |
| Rules | No. | Rule description | Error code | Error message | Attributes |
| | 0. | If an attribute has defined possible values, the value index can be specified by specifying the value of the attribute in the request. Indices of all possible values start from 0. | - | - | - |
| | 1. | The supplier will be identified by the authentication key. | 1003 | The independent supplier cannot be found in the system or supplier is not active. | Independent_supplier.id, cancellation_notification.independent_supplier_id |
| | 2. | Attributes [ObjectNumber], [cancelledNotificationId], [cancelledNotificationType] are mandatory. | - | One or more request parameters are required. | objectNumber |

| | | | | | |
|--|----|---|----------|---|---|
| | 3. | <p>The values for the [cancelledNotificationType] attribute must be:</p> <ul style="list-style-type: none"> • STK – Owner and supplier change • NTK – Supplier change • SK – Owner change • SN – Contract termination • KT – Contact change • TPK – Tariff plan change • AP – Supply state change <p>So far, the cancellation process has been implemented only for the NTK type.</p> | 10 02 | - | cancelledNotificationType |
| | 4. | The meaning of the [ObjectNumber] notification cannot be repeated. | 7 | The object: [objectNumber (if there is more than one object, objects must be separated by the semicolon)] is repeating | objectNumber |
| | 5. | The Supplier can only cancel requests it has made. | 60 1 | The request [cancelledNotificationId] does not belong to the supplier. | objectNumber |
| | 6. | All the objects of the submitted request must belong to the objects of the canceled request. | 60 2 | The object: [objectNumber (if there is more than one object, objects must be separated by the semicolon)] does not belong to the cancelled notification [cancelledNotificationId] | objectNumber, cancelledNotificationId |
| | 7. | <p>If the attribute [cancelledNotificationType]=NTK then:</p> <ul style="list-style-type: none"> ▪ The latest status of the cancelled request (cancelledNotificationId) must be IV – Completed. | 60 3 | If the cancelled request type is “NTK – Supplier change”, only completed requests can be cancelled. | cancelledNotificationId |
| | 8. | <p>If the attribute [cancelledNotificationType]=NTK, then:</p> <ul style="list-style-type: none"> ▪ The cancellation can be made 1 day before the end of the deadline for changing the Supplier. | 60 4 | If the cancelled request type is “NTK – Supplier change”, the cancellation can be made 1 day before the end of the deadline for changing the Supplier. | cancelledNotificationType, cancelledNotificationId |
| | 9 | <p>With one cancellation request, it can cancel:</p> <ul style="list-style-type: none"> • a single request, specifying the request and all its objects to be canceled, or | - | - | - |

| | | | | | |
|-----|---|--|--|---|--|
| | | <ul style="list-style-type: none"> not all objects of a single request, specifying the request to be canceled and its objects to be canceled in that request. | | | |
| 10. | Only one non-canceled/non-erroneous cancellation request is possible for the same objectNumber, cancelledNotificationId, cancelledNotificationType, independentSupplierId. | 60 5 | The cancellation request for object [objectNumber (if there is more than one object, objects must be separated by the semicolon)] is already submitted to the system | objectNumber, cancelledNotificationId, cancelledNotificationType, independentSupplierId | |
| 11. | The meaning of the [consentSign] must be: <ul style="list-style-type: none"> True or False. | | - | consentSign | |
| 12. | If the attribute [consentSign] = False , then the cancellation of notification must be disabled. | 32 | It is necessary to confirm that the data provided is correct. | consentSign | |
| 13. | Upon successful creation of a cancellation request, the status of the request becomes "Submitted". | - | - | - | |
| 13. | If the status of the canceled request [cancelledNotificationId] is IV, then it is checked whether the date_modified of the canceled request is later than the date of the last data import. | 60 6 | Due to possible duplication of information, such a notification to object [objectNumber] is not possible. Please try after 30 minutes. | cancelledNotificationId, object number | |
| 14. | It is not possible to cancel if another supplier has already canceled the object contract or independent supplier object valid from date is not equal to contract change notification object's contract start date . | 60 7 | A cancellation request for object [objectNumber (if there is more than one object, objects must be separated by the semicolon)] is not possible, another supplier has canceled the contract for the object or the object contract is canceled in the operator's system . | objectNumber, cancelledNotificationId, cancelledNotificationType | |
| 15. | Supply disconnection due to debt cannot be canceled if the facility is equipped with an MDM (new SMART) meter and the request to submitted between [SUPPLY_STATE_NOTIFICATION_UNABLE_TO_CANCEL_FROM_HOUR] until | 60 8 | Supply disconnection due to debt requests cannot be canceled between[SUPPLY_STATE_NOTIFICATION_UNABLE_TO_CANCEL_FROM_HOUR] until [SUPPLY_STATE_NOTIFICATION_UNABLE_TO_CANCEL_UNTIL_HOUR] hours. | cancelledNotificationType | |

| |
|--|
| [SUPPLY_STATE_NOTIFICATION_UNABLE_TO_CANCEL_UNTIL_HOUR] hours. |
|--|

7.8.2.1 JSON Request structure

The table below describes the structure of the JSON request:

| No. | Attribute | type | obligation | description |
|-----|---------------------------|------------|------------|--|
| 1. | cancelledNotificationId | Integer | required | Identifier of the cancellation request. |
| 2. | cancelledNotificationType | String(10) | required | <p>Cancellation request type. Possible values are:</p> <ul style="list-style-type: none"> • STK – owner and supplier change • NTK – supplier change • SK – owner change • SN – termination of contract • KT – change of contacts • TPK – Change of tariff plans • AP – Disconnect / connect <p>For now It is possible submit only type NTK.</p> |
| 3. | consentSign | Boolean | required | An indication of whether the cancellation data provided is correct. |
| 4. | objectNumbers | String | required | The object number for which the request of object cancellation is performed. |

7.8.2.2 JSON Response structure

The table below describes the structure of the JSON response:

| No. | Attribute | type | obligation | description |
|-----|----------------|---------|------------|--------------------|
| 1. | notificationId | Integer | required | Request identifier |

7.8.2.3 Error Response structure

The following table describes the JSON structure in the event of a response error:

| No. | Attribute | type | obligation | description |
|-----|-----------|--------------|------------|----------------|
| 1. | code | number | required | Error code. |
| 2. | text | string(4000) | required | Error message. |

7.8.3 POST /gateway/notification/{notificationId}/cancellation/cancel

| | | | |
|---------------------------|---|---------------|--|
| URI | POST /gateway/notification/{notificationId}/cancellation/cancel | | |
| Description | The method is designed to cancel cancelation request | | |
| Parameters | URL: <ul style="list-style-type: none"> notificationId – request identifier. Required | | |
| Header | After decrypting the supplier authentication key, the supplier ID is used to check or supplier cancel his own request | | |
| JSON request | In POST request there isn't BODY | | |
| Response HTTP code | HTTP status code | Reason | Description |
| | 201 | Created | Request completed successfully |
| | 400 | Bad Request | Request error. The HTTP response body provides a list of errors in JSON format. (<i>Error response of the JSON structure below</i>). |
| | 401 | Unauthorized | An attempt was made to connect to a non-public method that requires authentication, but no user credentials were provided. |
| | 403 | Forbidden | According to the access control policy, the current user does not have access to perform the requested action. |
| | 404 | Not Found | Either there is no API method associated with the request URL path, or the request contains one or more parameters that did not return the data. |

| | | | | | |
|----------------------------|---|---|-------------------|---|-------------------|
| JSON response | - | | | | |
| JSON error response | <pre>{ "errorMessages": [{ "code": 0, "text": "string" }] }</pre> | | | | |
| Rules | No. | Rule description | Error code | Error message | Attributes |
| | 0. | If an attribute has defined possible values, the value index can be specified by specifying the value of the attribute in the request. Indices of all possible values start from 0. | - | - | - |
| | 1. | The request can be canceled: <ul style="list-style-type: none"> only one time; when the notification state is "Pateiktas"; when the cancellation deadline has not passed (Initial value - 1 hour). | 50 | According to the given parameters, the message to be canceled could not be found / the cancellation deadline has expired / the message has already been canceled. | - |
| | 2. | Upon successful cancellation of the cancellation request, the status of the request becomes "Atšauktas". | - | - | - |

7.8.3.1 Error Response structure

The following table describes the JSON structure in the event of a response error:

| No. | Attribute | type | obligation | description |
|-----|-----------|--------|------------|-------------|
| 1. | code | number | required | Error code. |

| No. | Attribute | type | obligation | description |
|-----|-----------|--------------|------------|----------------|
| 2. | text | string(4000) | required | Error message. |

7.9 Notification contract tariff plan controller

7.9.1 POST /gateway/notification/contract/tariff-plan/list?first={integer}&count={integer}&sortKey={string}&sortOrder={ASC/DSC}

| | |
|--------------------|---|
| URL | POST /gateway/notification/contract/tariff-plan/list??first={integer}&count={integer}&sortKey={string}&sortOrder={ASC/DSC} |
| Description | The method is designed to obtain an information of tariff change |
| Parameters | <p>URL:</p> <ul style="list-style-type: none"> • first - index (starting from 0) of the notification that must be presented first in the return list. Optional. The default value is 0. • count - number of objects in the return list. Optional. The default value is 30. • sort - possible values ASC, DSC. <p>The data of the JSON form request are presented in the HTTP request body (BODY) (Query JSON structure, below).</p> |
| Header | After decrypting the supplier authentication key, the supplier ID is used to select the data. |
| Request | <pre>{ "notificationId":"number", "personCode":"string", "consumerCode":"string", "objectNumber":"string", "objectAddressSearch":"string", "status":"string", "submittedDateFrom":"datetime", "submittedDateTo":"datetime", "newTariffPlanSearch":"string", "newTimeZone":"string", "newPayoffMethod":"string", "contractType":"string",</pre> |

| | | | |
|----------------------------|---|---------------|--|
| | <pre>"contractModel":"string", "userNameSearch":"string" }</pre> | | |
| Response HTTP codes | HTTP status code | Reason | Description |
| | 200 | OK | Request completed successfully. |
| | 204 | No Content | No data found according to the given parameters. |
| | 400 | Bad Request | Request error. The HTTP response body provides a list of errors in JSON format. (<i>Error response of the JSON structure below</i>). |
| | 401 | Unauthorized | An attempt was made to connect to a non-public method that requires authentication, but no user credentials were provided. |
| | 403 | Forbidden | According to the access control policy, the current user does not have access to perform the requested action. |
| | 404 | Not Found | Either there is no API method associated with the request URL path, or the request contains one or more parameters that did not return the data. |
| Response | <pre>[{ "notificationId":"number", "latestStatus":"string", "errorType":"string", "submittedDate":"datetime", "userName":"string", "objects":[{ "personName":"string", "personSurname":"string", "personCode":"string", "consumerCode":"string", "objectNumber":"string", "objectAddress":"string", "contractType":"string", "contractModel":"string", "tariffPlan":"string",</pre> | | |

```

        "timeZone":"string",
        "payoffMethod":"string",
        "newTariffPlan":"string",
        "newTimeZone":"string",
        "newPayoffMethod":"string"
    }
],
"status":[
    {
        "status":"string",
        "statusDate":"datetime"
    }
]
}
]

```

JSON error response

```

{
  "errorMessages": [
    {
      "code": 0,
      "text": "string"
    }
  ]
}

```

| Rules | No. | Rule description | Error code | Error message | Attributes |
|-------|-----|---|------------|---------------|------------|
| | 0. | If an attribute has defined possible values, the value index can be specified by specifying the value of the attribute in the request. Indices of all possible values start from 0. | - | - | - |
| | 1. | No data found according to the given parameters. | HTTP 204 | - | - |

| | | | | | |
|--|----|--|------|---------------------------------------|---------------------------------------|
| | 2. | DateFrom cannot be later than DateTo. Equal can be. | 1002 | DateFrom cannot be later than DateTo. | submittedDateFrom, submittedDateTo |
|--|----|--|------|---------------------------------------|---------------------------------------|

7.9.1.1 JSON Request structure

The table below describes the structure of the JSON request:

| No. | Attribute | type | obligation | Description |
|-----|---------------------|--------------|--------------|---|
| 1. | notificationId | Integer | not required | Tariff plan change notification ID |
| 2. | personCode | String(20) | not required | Contract owner / tenant person / company code. |
| 3. | consumerCode | String(20) | not required | Contract owner / tenant consumer code. |
| 4. | objectNumber | String(20) | not required | Object number. |
| 5. | objectAddressSearch | String(4000) | not required | Object address. The search by the fragment. |
| 6. | status | String(20) | not required | Notification newest status. Possible meanings: <ul style="list-style-type: none"> • P - Submitted • A - Cancelled • I - Sent • V – In progress • IV - Completed • K - Error |
| 7. | submittedDateFrom | DateTime | not required | <ul style="list-style-type: none"> • The submission date from of the notification. • Format: yyyy-mm-dd |
| 8. | submittedDateTo | DateTime | not required | <ul style="list-style-type: none"> • The summation date to of the notification. • Format: yyyy-mm-dd |
| 9. | contractType | String(20) | not required | Contract type of the current object. Possible meanings: <ul style="list-style-type: none"> • SBTS - Household customer; • SKMS - Commercial customer. |

| No. | Attribute | type | obligation | Description |
|-----|---------------------|-------------|--------------|---|
| 10. | contractModel | String(10) | not required | Contract model of the current object. Possible meanings: <ul style="list-style-type: none"> • BSS - General contract bills; • 2S2S - Two contracts – Two bills. |
| 11. | newTariffPlanSearch | String(200) | not required | <ul style="list-style-type: none"> • Object's full name of the tariff plan; • Search by the fragment. |
| 12. | newTimeZone | String(4) | not required | Current time zone of the object. Possible meanings: <ul style="list-style-type: none"> • 1 - One; • 2 - Two; • VR - One with reactive; • 4 - Four (Smart); • DR - Differentiated with reactive; • N - Not established. |
| 13. | newPayoffMethod | String(1) | not required | A new payment method for the producing user. Possible values: <ul style="list-style-type: none"> • E - kWh - Recovered electricity energy; • G - kW - The power plant's permissible power; • P - % - Settlement percentage; • S – kWh – PP recovered electricity. |
| 14. | userNameSearch | String(240) | not required | The user who created a notification. Search by the fragment. |

7.9.1.2 JSON Response structure

The table below describes the structure of the JSON response:

| No. | Attribute | type | obligation | description |
|-----|----------------|------------|------------|--|
| 1. | notificationId | Integer | required | Tariff plan change notification ID. |
| 2. | latestStatus | String(20) | required | Notification newest status. Possible meanings: <ul style="list-style-type: none"> • P - Submitted |

| No. | Attribute | type | obligation | description |
|-----|---------------|--------------|--------------|--|
| | | | | <ul style="list-style-type: none"> • A - Cancelled • I - Sent • V – In progress • IV - Completed • K - Error |
| 3. | errorType | String(10) | not required | Notification error type if status=K (Error). |
| 4. | submittedDate | DateTime | required | The submission date of the notification |
| 5. | userName | String(240) | not required | The user who initiates the tariff plan change notification |
| 6. | personName | String(200) | required | Contract owner / tenant / company name. |
| 7. | PersonSurname | String(50) | not required | Contract owner / tenant surname. |
| 8. | personCode | String(20) | not required | <p>Person / tenant / company code.</p> <p>If the subject is an individual than person code must be returned encrypted: [*****][the last 3 symbols of the person code]</p> |
| 9. | consumerCode | String(20) | required | Contract owner / tenant consumer code. |
| 10. | objectNumber | String(20) | required | Object number. |
| 11. | objectAddress | String(4000) | required | Object address. |
| 12. | contractType | String(10) | required | <p>Contract type of the current object. Possible meanings:</p> <ul style="list-style-type: none"> • SBTS - Household customer; • SKMS - Commercial customer. |
| 13. | contractModel | String(10) | required | <p>Contract model of the current object. Possible meanings:</p> <ul style="list-style-type: none"> • BSS - General contract bills; |

| No. | Attribute | type | obligation | description |
|-----|---------------|-------------|------------|--|
| | | | | <ul style="list-style-type: none"> • 2S2S - Two contracts – Two bills. |
| 14. | tariffPlan | String(200) | required | The object tariff plan. The tariff plan was saved as current during the notification submission. |
| 15. | timeZone | String(4) | required | <p>Time zone of the object which was saved as current. Possible meanings:</p> <ul style="list-style-type: none"> • 1 - One; • 2 - Two; • VR - One with reactive; • 4 - Four (Smart); • DR - Differentiated with reactive; • N - Not established. |
| 16. | payoffMethod | String(1) | required | <p>The method of payment by the producing user. Possible values:</p> <ul style="list-style-type: none"> • E - kWh - Recovered electricity energy; • G - kW - The power plant's permissible power; • P - % - Settlement percentage; • S – kWh – PP recovered electricity. |
| 17. | newTariffPlan | String(200) | required | The new tariff plan of the object |
| 18. | newTimeZone | String(4) | required | <p>The new time zone of the object. Possible meanings:</p> <ul style="list-style-type: none"> • 1 - One; • 2 - Two; • VR - One with reactive; • 4 - Four (Smart); • DR - Differentiated with reactive; • N - Not established. |

| No. | Attribute | type | obligation | description |
|-----|-----------------|------------|------------|---|
| 19. | newPayoffMethod | String(1) | required | A new payment method for the producing user. Possible values: <ul style="list-style-type: none"> • E - kWh - Recovered electricity energy; • G - kW - The power plant's permissible power; • P - % - Settlement percentage; • S – kWh – PP recovered electricity. |
| 20. | status | String(10) | required | Notification all status. Possible meanings: <ul style="list-style-type: none"> • P - Submitted • A - Cancelled • I - Sent • V – In progress • IV - Completed • K - Error |
| 21. | statusDate | DateTime | required | Date of the status. |

7.9.1.3 Error Response structure

The following table describes the JSON structure in the event of a response error:

| No. | Attribute | type | obligation | description |
|-----|-----------|--------------|------------|----------------|
| 1. | code | number | required | Error code. |
| 2. | text | string(4000) | required | Error message. |

7.9.2 POST /gateway/notification/contract/tariff-plan

| | |
|------------|---|
| URL | POST /gateway/notification/contract/tariff-plan |
|------------|---|

| | | | |
|----------------------------|---|--|--|
| Description | The method is for independent supplier to transfer the tariff plan change to DataHub. | | |
| Parameters | URL: The data of the JSON form request are presented in the HTTP request body (BODY) (Query JSON structure, below). | | |
| Header | After decrypting the supplier authentication key, the supplier ID is used to select the data. | | |
| Request | <pre> { "consentSign":"boolean", "objects":[{ "objectNumber":"string", "newTariffPlan":"string", "newTimeZone":"string", "newPayoffMethod":"string" }] } </pre> | | |
| Response HTTP codes | HTTP status code | Reason | Description |
| | 201 | Created | Request completed successfully |
| | 204 | No Content | No data found according to the given parameters. |
| | 400 | Bad Request | Request error. The HTTP response body provides a list of errors in JSON format. (<i>Error response of the JSON structure below</i>). |
| | 401 | Unauthorized | An attempt was made to connect to a non-public method that requires authentication, but no user credentials were provided. |
| | 403 | Forbidden | According to the access control policy, the current user does not have access to perform the requested action. |
| 404 | Not Found | Either there is no API method associated with the request URL path, or the request contains one or more parameters that did not return the data. | |
| Response | <pre> { "notificationId": "number" } </pre> | | |

| | | | | | |
|----------------------------|---|---|-------------------|---|-------------------|
| | } | | | | |
| JSON error response | <pre>{ "errorMessages": [{ "code": 0, "text": "string" }] }</pre> | | | | |
| Rules | No. | Rule description | Error code | Error message | Attributes |
| | 0. | If an attribute has defined possible values, the value index can be specified by specifying the value of the attribute in the request. Indices of all possible values start from 0. | - | - | - |
| | 3. | The supplier will be identified by the authentication key. | 1003 | The independent supplier cannot be found in the system or supplier is not active. | - |
| | 4. | The meaning of the [ObjectNumber] notification cannot be repeated. | 7 | The object: [objectNumber (if there is more than one object, objects must be separated by the semicolon)] is repeating. | objectNumber |
| | 5. | Must be specified valid object. | 8 | The object: [objectNumber (if there is more than one object, objects must be separated by the semicolon)] not found in the system. | objectNumber |
| | 6. | The object must belong to a valid supplier contract that | 9 | The object: [objectNumber (if there is more than one object, objects must be separated by the semicolon)] does not belong to a valid supplier contract. | objectNumber |

| | | | | |
|-----|--|-----|--|------------------------------------|
| | provides the notification. | | | |
| 7. | All objects of the notification must belong to the same contract. | 43 | Change not possible. Different contracts for submitted objects. | objectNumber |
| 8. | It is possible to change the tariff plan and/or time zone of the object, if the possible date of changing the tariff plan is earlier than or equal to the current date. | 302 | Tariff plan changes are not possible. The object: [objectNumber (if there is more than one object, objects must be separated by the semicolon)] possible tariff plan change date is later than the current date. | objectNumber, tariffPlanChangeDate |
| 9. | If the object contract type = SBTS, then the mandatory attribute is [newTariffPlan]. | 303 | For the object: [objectNumber] it is mandatory to indicate the tariff plan. | newTariffPlan |
| 10. | If the object contract type = SBTS, must be specified valid [newTariffPlan]. | 304 | There is no tariff plan [newTariffPlan]. | newTariffPlan |
| 11. | If the object contract type = SBTS, then the meaning of the [newTariffPlan] attribute must be: <ul style="list-style-type: none"> • Namai or • Namai plius or • Standartinis or • Išmanusis or • Vidutinė įtampa. | 305 | The object: [objectNumber] tariff plan must be "Namai" / "Namai plius" / "Standartinis" / "Išmanusis" / "Vidutinė įtampa". | newTariffPlan |

| | | | | |
|-----|--|-----|---|-------------------------------|
| 12. | If the object contract type = SBTS, then the new tariff plan must not coincide with the current tariff plan. | 306 | The object: [objectNumber] current tariff plan coincides with new tariff plan. | newTariffPlan |
| 13. | If the object contract type = SBTS and the current tariff plan of object is "Vidutinė įtampa", then the new [newTariffPlan] must be "Vidutinė įtampa". | 307 | The object: [objectNumber] current tariff plan is "Vidutinė įtampa", then the new tariff plan must be "Vidutinė įtampa". | newTariffPlan |
| 14. | If the object contract type =SBTS, then object tariffPlan=Vidutinė įtampa cannot be specified, if current tariffPlan of object is not "Vidutinė įtampa". | 308 | The object:[objectNumber] current tariff plan is not "Vidutinė įtampa", then the new tariff plan can be "Namai" / "Namai plius" / "Standartinis" / "Išmanusis". | newTariffPlan |
| 15. | If the contractType=SKMS the attribute [newTariffPlan] must not be specified. The current tariff plan will be assigned to the object. | 309 | Contract type of the object: [objectNumber] is SKMS, the new tariff plan cannot be specified. | newTariffPlan |
| 16. | The attribute [newTimeZone] is required. | - | - | newTimeZone |
| 17. | If the object contract type = SBTS and attribute [newTariffPlan] = Namai / Namai plius / Standartinis / Vidutinė | 310 | If the object [objectNumber] the contract type is SBTS and the new tariff plan is "Namai" or "Namai plius" or "Standartinis" or "Vidutinė įtampa", then the new time zone must be One or Two. | newTimeZone, newTariffPlan |

| | | | | |
|-----|--|-----|--|----------------------------|
| | <p>jtampa, then the attribute [newTimeZone] meaning must be:</p> <ul style="list-style-type: none"> • 1 or • 2. | | | |
| 18. | <p>If the object contract type = SBTS and attribute [newTariffPlan] = Işmanusis, then the attribute [newTimeZone] meaning must be:</p> <ul style="list-style-type: none"> • 4. | 311 | <p>If the object [objectNumber] the contract type is SBTS and the new tariff plan is "Işmanusis", then the new time zone must be "4 (Smart)".</p> | newTimeZone, newTariffPlan |
| 19. | <p>If the object contractType=SKMS and PermittablePowerConsumption <= 30 kw, the attribute's [newTimeZone] possible values:</p> <ul style="list-style-type: none"> • 1 or; • 2. | 312 | <p>If the contractType=SKMS of the object: [objectNumber] and PermittablePowerConsumption <= 30 kw, than the new time zone must be "One" or "Two".</p> | newTimeZone |
| 20. | <p>If the object contractType=SKMS and PermittablePowerConsumption > 30 kw, the attribute's</p> | 313 | <p>If the contractType=SKMS of the object: [objectNumber] and PermittablePowerConsumption > 30 kw, than the new time zone must be "One with reactive" or "Differentiated with reactive ones".</p> | newTimeZone |

| | | | | |
|-----|---|-----|---|--------------|
| | <p>[newTimeZone] possible values:</p> <ul style="list-style-type: none"> • VR or; • DR. | | | |
| 21. | <p>The meaning of the [consentSign] must be:</p> <ul style="list-style-type: none"> • True or • False. | - | - | consentSign |
| 22. | <p>If the attribute [consentSign] = False, then the tariff plan change must be disabled.</p> | 32 | It is necessary to confirm that the data provided is correct. | consentSign |
| 23. | <p>Upon successful creation of a tariff plan change request, the status of the request becomes "Submitted".</p> | - | - | - |
| 24. | <p>It is possible to change the tariff plan if the supply status of the object is T - Supplied. Otherwise, the change cannot be made.</p> | 320 | Change not possible. The object's: [objectNumber (if there is more than one object, objects must be separated by the semicolon)] supply status is not "T - Supplied". | objectNumber |
| 25. | <p>It must be checked whether the permissible power for use is specified for the object.</p> | 314 | Failed to set usable power for the object [objectNumber] . | objectNumber |

| | | | | | |
|--|-----|---|-----|---|---------------------------------------|
| | 26. | The attribute [payoffMethod] cannot be field if consumer type is not generating consumer [generatingObjectType is not G] or is not remote generating consumer [generatingObjectType is not N] and [contractType is not SBTS]. | 210 | Generating consumer payoff method can be field, if consumer type is GV or NGV and contract type - SBTS. | newPayoffMethod, generatingObjectType |
|--|-----|---|-----|---|---------------------------------------|

7.9.2.1 JSON Request structure

The table below describes the structure of the JSON request:

| No. | Attribute | type | obligation | description |
|-----|---------------|-------------|--------------|--|
| 1. | consentSign | Boolean | required | Indication of whether the data provided for the change of the tariff plan are correct. The default value is False. |
| 2. | objects:[] | | | |
| 3. | objectNumber | String(20) | required | Object number to whom was initiated tariff plan change. |
| 4. | newTariffPlan | String(200) | not required | The new tariff plan can be specified only for the SBTS. In the case of SKMS, the current tariff plan is set automatically. |
| 5. | newTimeZone | String(4) | required | The new time zone of the object. Possible meanings: <ul style="list-style-type: none"> • 1 - One; • 2 - Two; • VR - One with reactive; • 4 - Four (Smart); • DR - Differentiated with reactive; • N - Not established. |

| No. | Attribute | type | obligation | description |
|-----|-----------------|-----------|--------------|--|
| 6. | newPayoffMethod | String(1) | not required | <p>A new payment method for the producing user. Possible values:</p> <ul style="list-style-type: none"> • E - kWh - Recovered electricity energy; • G - kW - The power plant's permissible power; • P - % - Settlement percentage; • S – kWh – PP recovered electricity. |

7.9.2.2 JSON Response structure

The table below describes the structure of the JSON response:

| No. | Attribute | type | obligation | description |
|-----|----------------|---------|------------|-------------------------------------|
| 1. | notificationId | Integer | required | Identificatory of the notification. |

7.9.2.3 Error Response structure

The following table describes the JSON structure in the event of a response error:

| No. | Attribute | type | obligation | description |
|-----|-----------|--------------|------------|----------------|
| 1. | code | number | required | Error code. |
| 2. | text | string(4000) | required | Error message. |

7.9.3 POST /gateway/notification/{notificationId}/contract/tariff-plan/cancel

| | |
|--------------------|---|
| URL | POST /gateway/notification/{notificationId}/contract/tariff-plan/cancel |
| Description | The method is intended to cancel the tariff plan change. |

| | | | | | |
|----------------------------|---|--------------------------------------|--|----------------------|-------------------|
| Parameters | URL: | | | | |
| | <ul style="list-style-type: none"> notificationId – Identificatory of the notification. Parameter is mandatory. | | | | |
| Header | After decrypting the supplier authentication key, the supplier ID is used to select the data. | | | | |
| Request | There is no body in the JSON request. | | | | |
| Response HTTP codes | HTTP status code | Reason | Description | | |
| | 201 | Created | Request completed successfully | | |
| | 400 | Bad Request | Request error. The HTTP response body provides a list of errors in JSON format. (<i>Error response of the JSON structure below</i>). | | |
| | 401 | Unauthorized | An attempt was made to connect to a non-public method that requires authentication, but no user credentials were provided. | | |
| | 403 | Forbidden | According to the access control policy, the current user does not have access to perform the requested action. | | |
| | 404 | Not Found | Either there is no API method associated with the request URL path, or the request contains one or more parameters that did not return the data. | | |
| Response | | | | | |
| JSON error response | <pre>{ "errorMessages": [{ "code": 0, "text": "string" }] }</pre> | | | | |
| Rules | No. | Rule description | Error code | Error message | Attributes |
| | 0. | If an attribute has defined possible | - | - | - |

| | | | | | |
|----|---|--|----|---|---|
| | | values, the value index can be specified by specifying the value of the attribute in the request. Indices of all possible values start from 0. | | | |
| 1. | The request can be canceled: | <ul style="list-style-type: none"> • only one time; • when the notification state is "Pateiktas"; • when the cancellation deadline has not passed (Initial value - 1 hour). | 50 | According to the given parameters, the message to be canceled could not be found / the cancellation deadline has expired / the message has already been canceled. | - |
| 2. | Upon successful cancellation of the tariff plan request, the status of the request becomes "Atšauktas". | | - | - | - |

7.9.3.1 JSON Request structure

The table below describes the structure of the JSON response:

| No. | Attribute | type | obligation | description |
|-----|-----------|------|------------|-------------|
| | | | | |

7.9.3.2 JSON Response structure

The table below describes the structure of the JSON response:

| No. | Attribute | type | obligation | description |
|-----|-----------|------|------------|-------------|
| | | | | |

7.9.3.3 Error Response structure

The following table describes the JSON structure in the event of a response error:

| No. | Attribute | type | obligation | description |
|-----|-----------|--------------|------------|----------------|
| 1. | code | number | required | Error code. |
| 2. | text | string(4000) | required | Error message. |

7.10 Notification contract contact controller

7.10.1 POST /gateway/notification/contract/contact/list?first={integer}&count={integer}&sortKey={string}&sortOrder={ASC/DSC}

| | |
|--------------------|---|
| URI | POST /gateway/notification/contract/contact/list?first={integer}&count={integer}&sortKey={string}&sortOrder={ASC/DSC} |
| Description | The method is to obtain a list of contact changes. |
| Parameters | <p>URL:</p> <ul style="list-style-type: none"> • first - index (starting from 0) of the notification that must be presented first in the return list. Optional. The default value is 0. • count - number of objects in the return list. Optional. The default value is 30. • sort - possible values ASC, DSC. <p>The data of the JSON form request are presented in the HTTP request body (BODY) (Query JSON structure, below).</p> |
| Header | After decrypting the supplier authentication key, the supplier ID is used to select the data. |

| | | | |
|----------------------------|---|---------------|--|
| JSON request | <pre>{ "notificationId":"number", "personCode":"string", "consumerCode":"string", "objectNumber":"string", "objectAddressSearch":"string", "status":"string", "submittedDateFrom":"datetime", "submittedDateTo":"datetime", "contractType":"string", "newCorrespondenceAddressSearch":"string", "newPhoneSearch":"string", "newEmailSearch":"string", "userNameSearch":"string" }</pre> | | |
| Response HTTP codes | HTTP status code | Reason | Description |
| | 200 | OK | Request completed successfully. |
| | 204 | No Content | No data found according to the given parameters. |
| | 400 | Bad Request | Request error. The HTTP response body provides a list of errors in JSON format. (<i>Error response of the JSON structure below</i>). |
| | 401 | Unauthorized | An attempt was made to connect to a non-public method that requires authentication, but no user credentials were provided. |
| | 403 | Forbidden | According to the access control policy, the current user does not have access to perform the requested action. |
| | 404 | Not Found | Either there is no API method associated with the request URL path, or the request contains one or more parameters that did not return the data. |
| JSON response | <pre>[{ "notificationId":"number", "personName":"string", }]</pre> | | |

```
"personSurname": "string",
"personCode": "string",
"consumerCode": "string",
"contractType": "string",
"submittedDate": "datetime",
"latestStatus": "string",
"errorType": "string",
"userName": "string",
"newContact": {
  "newCorrespondenceAddress": "string",
  "newMobPhoneNoNetwork": "string",
  "newMobPhoneNo2Network": "string",
  "newPhoneNoNetwork": "string",
  "newMobPhoneNoInvoice": "string",
  "newEmailNetwork": "string",
  "newEmail2Network": "string",
  "newEmailInvoice": "string"
},
"contact": {
  "correspondenceAddress": "string",
  "mobPhoneNoNetwork": "string",
  "mobPhoneNo2Network": "string",
  "phoneNoNetwork": "string",
  "mobPhoneNoInvoice": "string",
  "emailNetwork": "string",
  "email2Network": "string",
  "emailInvoice": "string"
},
"objects": [
  {
    "objectNumber": "string",
    "objectAddress": "string",
```

| | | | | | |
|----------------------------|--|---|-------------------|---------------------------------------|------------------------------------|
| | <pre> "newMobPhoneNoObject": "string", "mobPhoneNoObject": "string" }], "status": [{ "status": "string", "statusDate": "datetime" }] }] </pre> | | | | |
| JSON error response | <pre> { "errorMessages": [{ "code": 0, "text": "string" }] } </pre> | | | | |
| Rules | No. | Rule description | Error code | Error message | Attributes |
| | 0. | If an attribute has defined possible values, the value index can be specified by specifying the value of the attribute in the request. Indices of all possible values start from 0. | - | - | - |
| | 1. | No data found according to the given parameters. | HTTP 204 | - | - |
| | 2. | DateFrom cannot be later than DateTo. Equal can be | 1002 | DateFrom cannot be later than DateTo. | submittedDateFrom, submittedDateTo |

7.10.1.1 JSON Request structure

The table below describes the structure of the JSON request:

| No. | Atributte | Type | Obligation | Description |
|-----|--------------------------------|--------------|--------------|--|
| 1. | notificationId | Integer | not required | Contact change notification ID. |
| 2. | personCode | String(20) | not required | Contract owner / tenant person / company code. |
| 3. | consumerCode | String(20) | not required | Contract owner / tenant consumer code. |
| 4. | objectNumber | String(20) | not required | Object number. |
| 5. | objectAddressSearch | String(4000) | not required | Object address. The search by the fragment. |
| 6. | status | String(20) | not required | Notification status. Possible meanings: <ul style="list-style-type: none"> • P - Submitted • A - Cancelled • I - Sent • V – In progress • IV - Completed • K - Error |
| 7. | submittedDateFrom | DateTime | not required | The submission date from of the notification. Format: yyyy-mm-dd |
| 8. | submittedDateTo | DateTime | not required | The summation date to of the notification. Format: yyyy-mm-dd |
| 9. | contractType | String(20) | not required | Contract type of the current object. Possible meanings: <ul style="list-style-type: none"> • SBTS - Household customer; • SKMS - Commercial customer. |
| 10. | newCorrespondenceAddressSearch | String(4000) | not required | <ul style="list-style-type: none"> • Contract owner's / tenant's full name of correspondence address. • Search by the fragment. |
| 11. | newPhoneSearch | String(4) | not required | <ul style="list-style-type: none"> • Search by the fragment. |

| No. | Atributte | Type | Obligation | Description |
|-----|----------------|-------------|--------------|--|
| | | | | <ul style="list-style-type: none"> Searching for these contacts: <ul style="list-style-type: none"> Contract owner's / tenant's new mobile phone number for the network. Contract owner's / tenant's new additional mobile phone number for the network. Contract owner's / tenant's new mobile phone number for the invoice. Contract owner's / tenant's new phone number for the network. Object's new mobile phone number for the network. |
| 12. | newEmailSearch | string(100) | not required | <ul style="list-style-type: none"> Search by the fragment. Searching for these contacts: <ul style="list-style-type: none"> Contract owner's / tenant's new email address for the network; Contract owner's / tenant's new additional email address for the network. Contract owner's / tenant's new email address for the invoice; |
| 13. | userNameSearch | String(240) | not required | The user who created a notification. Search by the fragment. |

7.10.1.2 JSON Response structure

The table below describes the structure of the JSON response:

| No. | Attribute | Type | Obligation | Description |
|-----|----------------|-------------|--------------|--|
| 1. | notificationId | integer | required | Contact change notification ID. |
| 2. | personName | string(200) | required | Contract owner / tenant / company name. |
| 3. | personSurname | string(50) | not required | Contract owner / tenant surname. |
| 4. | personCode | string(15) | required | Contract owner / tenant person / company code. |
| 5. | consumerCode | string(20) | required | Contract owner / tenant consumer code. |

| No. | Attribute | Type | Obligation | Description |
|--------------|--------------------------|--------------|--------------|---|
| 6. | contractType | string(10) | required | Contract type of the current object. Possible meanings: <ul style="list-style-type: none"> • SBTS - Household customer; • SKMS - Commercial customer. |
| 7. | submittedDate | DateTime | required | The submission date of the notification |
| 8. | latestStatus | string(10) | required | Notification newest status. Possible meanings: <ul style="list-style-type: none"> • P - Submitted • A - Cancelled • I - Sent • V – In progress • IV - Completed • K - Error |
| 9. | errorType | String(10) | not required | Notification error type if status=K (Error). |
| 10. | userName | string(240) | required | The user who initiates the contact change notification |
| newContact{} | | | | |
| 11. | newCorrespondenceAddress | string(4000) | required | Contract owner's / tenant's full name of new correspondence address. |
| 12. | newMobPhoneNoNetwork | string(12) | not required | Contract owner's / tenant's new mobile phone number for the network. |
| 13. | newMobPhoneNo2Network | string(12) | not required | Contract owner's / tenant's new additional mobile phone number for the network. |
| 14. | newPhoneNoNetwork | string(12) | not required | Contract owner's / tenant's new phone number for the network. |
| 15. | newMobPhoneNoInvoice | string(12) | not required | Contract owner's / tenant's new mobile phone number for the invoice. |
| 16. | newEmailNetwork | string(49) | not required | Contract owner's / tenant's new email address for the network. |

| No. | Attribute | Type | Obligation | Description |
|-------------|-----------------------|--------------|--------------|---|
| 17. | newEmail2Network | string(49) | not required | Contract owner's / tenant's new additional email address for the network. |
| 18. | newEmailInvoice | string(100) | not required | Contract owner's / tenant's new email address for the invoice. |
| contact: {} | | | | |
| 19. | correspondenceAddress | string(4000) | not required | Contract owner's / tenant's full name of correspondence address. |
| 20. | mobPhoneNoNetwork | string(12) | not required | Contract owner's / tenant's mobile phone number for the network. |
| 21. | mobPhoneNo2Network | string(12) | not required | Contract owner's / tenant's additional mobile phone number for the network. |
| 22. | phoneNoNetwork | string(12) | not required | Contract owner's / tenant's phone number for the network. |
| 23. | mobPhoneNoInvoice | string(12) | not required | Contract owner's / tenant's mobile phone number for the invoice. |
| 24. | emailNetwork | string(49) | not required | Contract owner's / tenant's email address for the network. |
| 25. | email2Network | string(49) | not required | Contract owner's / tenant's additional email address for the network. |
| 26. | emailInvoice | string(100) | not required | Contract owner's / tenant's email address for the invoice. |
| objects: [] | | | | |
| 27. | objectNumber | string(20) | required | Contract object number. |
| 28. | objectAddress | string(4000) | required | Full name of the contract object address. |
| 29. | newMobPhoneNoObject | string(12) | not required | Object's new mobile phone number for the network. |
| 30. | mobPhoneNoObject | string(12) | not required | Object's mobile phone number for the network. |
| status: [] | | | | |
| 31. | status | String(10) | required | Notification newest status. Possible meanings: <ul style="list-style-type: none"> • P - Submitted • A - Cancelled |

| No. | Attribute | Type | Obligation | Description |
|-----|------------|----------|------------|--|
| | | | | <ul style="list-style-type: none"> • I - Sent • V – In progress • IV - Completed • K - Error |
| 32. | statusDate | DateTime | required | Notification status date. |

7.10.1.3 Error Response structure

The following table describes the JSON structure in the event of a response error:

| No. | Attribute | Type | Obligation | Description |
|-----|-----------|--------------|------------|----------------|
| 1. | code | number | required | Error code. |
| 2. | text | string(4000) | required | Error message. |

7.10.2 POST /gateway/notification/contract/contact

| | |
|---------------------|---|
| URI | POST /gateway/notification/contract/contact |
| Description | The method is for independent supplier to transfer the contact change to DataHub. |
| Parameters | <p>URI:</p> <p>The data of the JSON form request are presented in the HTTP request body (BODY) (Query JSON structure, below).</p> |
| Header | After decrypting the supplier authentication key, the supplier ID is used to select the data. |
| JSON request | <pre>{ "consumerCode":"string", "consentSign":"boolean",</pre> |

```

"newCorrespondenceAddress":{
  "newStreet":"string",
  "newBuilding":"string",
  "newHousingNo":"string",
  "newAppartement":"string",
  "newLocality":"string",
  "newEldership":"string",
  "newMunicipality":"string",
  "newCounty":"string"
},
"newContact":{
  "newMobPhoneNoNetwork":"string",
  "newMobPhoneNo2Network":"string",
  "newMobPhoneNoInvoice":"string",
  "newPhoneNoNetwork":"string",
  "newEmailNetwork":"string",
  "newEmail2Network":"string",
  "newEmailInvoice":"string"
},
"objects":[
  {
    "objectNumber":"string",
    "newMobPhoneNoObject":"string"
  }
]
}

```

| Response HTTP codes | HTTP status code | Reason | Description |
|---------------------|------------------|---------|--------------------------------|
| | 201 | Created | Request completed successfully |

| | | | | | |
|----------------------------|---|---|--|---|-------------------|
| | 400 | Bad Request | Request error. The HTTP response body provides a list of errors in JSON format. (<i>Error response of the JSON structure below</i>). | | |
| | 401 | Unauthorized | An attempt was made to connect to a non-public method that requires authentication, but no user credentials were provided. | | |
| | 403 | Forbidden | According to the access control policy, the current user does not have access to perform the requested action. | | |
| | 404 | Not Found | Either there is no API method associated with the request URL path, or the request contains one or more parameters that did not return the data. | | |
| JSON response | <pre>{ "notificationId": "number" }</pre> | | | | |
| JSON error response | <pre>{ "errorMessages": [{ "code": 0, "text": "string" }] }</pre> | | | | |
| Rules | No. | Rule description | Error code | Error message | Attributes |
| | 0. | If an attribute has defined possible values, the value index can be specified by specifying the value of the attribute in the request. Indices of all possible values start from 0. | - | - | - |
| | 1. | The supplier will be identified by the authentication key. | 1003 | The independent supplier cannot be found in the system or supplier is not active. | - |
| | 2. | The attribute consumerCode is mandatory. | - | - | consumerCode |

| | | | | |
|----|---|-----|---|---|
| 3. | The change of contacts can only be performed for the contract that is valid at the moment and the objects of the contract belong to the supplier initiating the change. | 410 | Change not possible. No valid contract found. | consumerCode |
| 4. | If the contract type = SBTS, then must be at least one contact attribute: <ul style="list-style-type: none"> • [newMobPhoneNoNetwork] or • [newTelPhoneNoNetwork] or • [newEmailNetwork] | 415 | If the contract type is "SBTS", it is mandatory to specify at least one attribute: "Mob. phone no." or "Phone no." or "Email address". | newMobPhoneNoNetwork, newEmailNetwork, newTelPhoneNoNetwork |
| 5. | If the contract type = SKMS, then must be at least one contact attribute: <ul style="list-style-type: none"> • [newMobPhoneNoNetwork] or • [newEmailNetwork]. and one of contacts for the invoices; <ul style="list-style-type: none"> • [newMobPhoneNoInvoice] or • [newEmailInvoice]. | 416 | If the contract type is "SKMS", it is mandatory to specify one of the contacts for network work: "Mob. phone no." or "Email Address" and one of the contacts for accounts: "Mob. phone no." or "Email Address". | newMobPhoneNoNetwork, newEmailNetwork, newMobPhoneNoInvoice, newEmailInvoice |
| 6. | If the contract type=SBTS then attributes [newMobPhoneNoInvoice] and [newEmailInvoice] cannot be filled. | 417 | If the contract type "SBTS", then invoice "Mob. phone No." and invoice "Email address" cannot be filled. | newMobPhoneNoInvoice, newEmailInvoice |
| 7. | The format of the attributes [newMobPhoneNoNetwork], [newMobPhoneNo2Network], [newMobPhoneNoInvoice] must be : +3706XXXXXXX, X - an integer (0 must be included). The format of the attribute [newPhoneNoNetwork] must be : +370XXXXXXX, X - an integer (0 must | 418 | "Mob. phone No.", "Mob. phone No. (optional)" and "Phone no." incorrect format. | newMobPhoneNoNetwork, newMobPhoneNo2Network, newMobPhoneNoInvoice, newPhoneNoNetwork |

| | | | | |
|-----|---|-----|--|--|
| | be included). The next number after +370 cannot be 6. | | | |
| 8. | The format of the attributes [newEmailNetwork], [newEmail2Network], [newEmailInvoice] must be [text][@][text][.domain], letters in the text must be Latin. Can be at most 64 characters up to @ symbol. | 419 | An "Email address" and "Email address (optional)" incorrect format. | newEmailNetwork, newEmail2Network, newEmailInvoice |
| 9. | The attributes [objectNumber] and [newMobPhoneObject] are only filled in if the contract type is SKMS. The attribute [ObjectNumber] is mandatory if the attribute [newMobPhoneNoObject] is not null. | 411 | If the contract type is SKMS and "Mobile Phone No." of faults is specified, then "Object No." must be specified. | objectNumber, newMobPhoneNoObject |
| 10. | The meaning of the [ObjectNumber] notification cannot be repeated. | 421 | The object: [objectNumber] is repeating. | objectNumber |
| 11. | Must be specified valid object. The object must belong to a valid supplier contract that provides the notification and the object must have at least one valid meter. All objects of the notification must belong to the same contract. | 422 | The object: [objectNumber] not found in the system / not belong to a valid supplier contract. | objectNumber |
| 12. | The format of the attribute [newMobPhoneNoObject] must be : +3706XXXXXXX, X - an integer (0 must be included). | 414 | "Mob. phone No." incorrect format. | newMobPhoneNoObject |
| 13. | The meaning of the [consentSign] must be: <ul style="list-style-type: none"> • True or • False. | - | - | consentSign |

| | | | | | |
|--|-----|--|----|---|-------------|
| | 14. | If the attribute [consentSign] = False, then the tariff plan change must be disabled. | 32 | It is necessary to confirm that the data provided is correct. | consentSign |
| | 15. | Upon successful creation of a contact change request, the status of the request becomes "Submitted". | - | - | - |

7.10.2.1 JSON Request structure

The table below describes the structure of the JSON request:

| No. | Attribute | Type | Obligation | Description |
|------------------------------|----------------------|--------------|------------|---|
| 1. | consumerCode | Strign(20) | required | Contract owner / tenant consumer code. |
| 2. | consentSign | Boolean | required | Indication that the contact change data provided are correct. The default value is False. |
| newcorrespondenceAddress: {} | | | | |
| 3. | newStreet | Varchar(200) | N | New correspondence address's street. |
| 4. | newBuilding | Varchar(100) | N | New correspondence address's number of the house. |
| 5. | newHousingNo | Varchar(100) | N | New Correspondence Address's Corps Number. |
| 6. | newAppartment | Varchar(20) | N | New correspondence address's apartment number. |
| 7. | newLocality | Varchar(200) | N | New correspondence address's city / village. |
| 8. | newEldership | Varchar(200) | N | New correspondence address's eldership. |
| 9. | newMunicipality | Varchar(200) | N | New correspondence address's municipality. |
| 10. | newCounty | Varchar(200) | N | New Correspondence Address's County. |
| newContact: {} | | | | |
| 11. | newMobPhoneNoNetwork | Varchar(12) | N | Contract owner's / tenant's new mobile phone number for the network. |

| No. | Attribute | Type | Obligation | Description |
|---|-----------------------|--------------|------------|---|
| 12. | newMobPhoneNo2Network | Varchar(12) | N | Contract owner's / tenant's new additional mobile phone number for the network. |
| 13. | newMobPhoneNoInvoice | Varchar(12) | N | Contract owner's / tenant's new mobile phone number for the invoice. |
| 14. | newPhoneNoNetwork | Varchar(12) | N | Contract owner's / tenant's new phone number for the network. |
| 15. | newEmailNetwork | Varchar(49) | N | Contract owner's / tenant's new email address for the network. |
| 16. | newEmail2Network | Varchar(49) | N | Contract owner's / tenant's new additional email address for the network. |
| 17. | newEmailInvoice | Varchar(100) | N | Contract owner's / tenant's new email address for the invoice. |
| object:[] Filled in only in case of SKMS | | | | |
| 18. | objectNumber | Varchar(20) | N | Contract object number. |
| 19. | newMobPhoneNoObject | Varchar(12) | N | Object's new mobile phone number for the network. |

7.10.2.2 JSON Response structure

The table below describes the structure of the JSON response:

| No. | Attribute | Type | Obligation | Description |
|-----|----------------|---------|------------|------------------|
| 1. | notificationId | Integer | required | Notification ID. |

7.10.2.3 Error Response structure

The following table describes the JSON structure in the event of a response error:

| No. | Attribute | Type | Obligation | Description |
|-----|-----------|--------|------------|-------------|
| 1. | code | number | required | Error code. |

| No. | Attribute | Type | Obligation | Description |
|-----|-----------|--------------|------------|----------------|
| 2. | text | string(4000) | required | Error message. |

7.10.3 POST /gateway/notification/{notificationId}/contract/contact/cancel

| | | | |
|----------------------------|--|---------------|--|
| URI | POST /gateway/notification/{notificationId}/contract/contact/cancel | | |
| Description | The method is intended to cancel the contact change. | | |
| Parameters | URL: <ul style="list-style-type: none"> notificationId – notification identifier. Mandatory | | |
| Header | The data of the JSON form request are presented in the HTTP request body (BODY) (Query JSON structure, below). | | |
| JSON request | There is no body in the JSON request. | | |
| Response HTTP codes | HTTP status codes | Reason | Description |
| | 201 | Created | Request completed successfully |
| | 400 | Bad Request | Request error. The HTTP response body provides a list of errors in JSON format. (<i>Error response of the JSON structure below</i>). |
| | 401 | Unauthorized | An attempt was made to connect to a non-public method that requires authentication, but no user credentials were provided. |
| | 403 | Forbidden | According to the access control policy, the current user does not have access to perform the requested action. |
| | 404 | Not Found | Either there is no API method associated with the request URL path, or the request contains one or more parameters that did not return the data. |

| | | | | | |
|----------------------------|---|--|-------------------|---|-------------------|
| JSON response | | | | | |
| JSON error response | <pre>{ "errorMessages": [{ "code": 0, "text": "string" }] }</pre> | | | | |
| Rule | No. | Rule description | Error code | Error message | Attributes |
| | 0. | If an attribute has defined possible values, the value index can be specified by specifying the value of the attribute in the request. Indices of all possible values start from 0. | - | - | - |
| | 1. | <p>The request can be canceled:</p> <ul style="list-style-type: none"> only one time; when the notification state is "Pateiktas"; <p>when the cancellation deadline has not passed (Initial value - 1 hour).</p> | 50 | According to the given parameters, the message to be canceled could not be found / the cancellation deadline has expired / the message has already been canceled. | - |
| | 2. | Upon successful cancellation of the contact request, the status of the request becomes "Atšauktas". | - | - | - |

7.10.3.1 JSON Request structure

The table below describes the structure of the JSON request:

| No. | Attribute | Type | Obligation | Description |
|-----|-----------|------|------------|-------------|
| 1. | | | | |

7.10.3.2 JSON Response structure

The table below describes the structure of the JSON response:

| No. | Attribute | Type | Obligation | Description |
|-----|-----------|------|------------|-------------|
| 4. | | | | |

7.10.3.3 Error Response structure

The following table describes the JSON structure in the event of a response error:

| No. | Attribute | Type | Obligation | Description |
|-----|-----------|--------------|------------|----------------|
| 1. | code | number | required | Error code. |
| 2. | text | string(4000) | required | Error message. |

7.11 Report controller

7.11.1 POST /reports/accounting-data-pack-b2c?first={integer}&count={integer}

| | | | | |
|---------------------|--|---------------|--|--------------------------------|
| URI | POST /reports/accounting-data-pack-b2c?first={integer}&count={integer} | | | |
| Description | Report which will return accounting data in meters level for Household customers. If household client object has two meters, this method will return list of two items. | | | |
| Parameters | URL parameters: first - the index of the report line, which must be the first in the return list (starting from 0). Optional. The default value is 0. count - the number of report rows in the return list. Optional. The default value is 30. | | | |
| Request Body | Data order must be submitted in HTTP request body in a form of JSON | | | |
| Response | HTTP status code | Reason | | Response description |
| | 201 | Created | | Request completed successfully |

| | | | |
|--------------|------------|--|---|
| | 400 | Bad Request | Request error. The HTTP response body provides a list of errors in JSON format. |
| | 401 | Unauthorized | An attempt was made to connect to a non-public method that requires authentication, but no user credentials were provided. |
| | 403 | Forbidden | According to the access control policy, the current user does not have access to perform the requested action. |
| | 404 | Not Found | Either there is no API method associated with the request URL path, or the request contains one or more parameters that did not return the data. |
| | 423 | Locked | The source or destination resource of a method is locked. This response SHOULD contain an appropriate precondition or postcondition code, such as 'lock-token-submitted' or 'no-conflicting-lock'. |
| Rules | No. | Rule description | Attributes |
| | 0. | If an attribute has defined possible values, the value index can be specified by specifying the value of the attribute in the request. Indices of all possible values start from 0. | All attributes with specified values. |
| | 1. | The value of the count parameter cannot be above 10 000. If the error occurs the error message 1004 will be displayed. | count |
| | 2. | Depending on the dateFrom and dateTo fields specified in the request, the request is executed and the report data is selected and submitted. If only date fields are specified, then the report returns information about all objects in all customer contracts. | dateFrom, dateTo |
| | 3. | Depending on the dateFrom and dateTo fields specified in the request, the request is executed and the report data is selected and submitted. If date fields and customerCode are specified, then the report returns information about all objects in provided customer contract. | dateFrom, dateTo, customerCode |

| | | | |
|--|----|--|--|
| | 4. | Depending on the dateFrom and dateTo fields specified in the request, the request is executed and the report data is selected and submitted. If date fields, customerCode and objectNo are specified, then the report returns information about provided object in provided customer contract. | dateFrom, dateTo, customerCode, objectNo |
| | 5. | The operator does not provide interim data. The operator provides only final / complete data. | - |

7.11.1.1 JSON Request structure

JSON Request structure

```
{
  "customerCode": "string",
  "dateFrom": "date",
  "dateTo": "date",
  "objectNo": "string"
}
```

| Attribute | type | obligation | description |
|--------------|------------|--------------|---|
| customerCode | String(32) | not required | User code of contracted customer |
| dateFrom | Date | required | Date from which data from DSO Billing system should be included into report |
| dateTo | Date | required | Date to which data from DSO Billing system should be included into report |
| objectNo | String(20) | not required | Object Number of the object for the supply of electricity in which the contract is concluded. |

The table below describes URL request attributes:

| Attribute | type | obligation | description |
|-----------|---------|--------------|--|
| first | integer | not required | Index (starting from 0) of the object that must be presented first in the return list. |
| count | integer | not required | Number of objects in the return list. |

7.11.1.2 JSON Response structure

JSON Response structure

```
[
{
"CustomerID": "string",
"ClientID": "string",
"ClientName": "string",
"ClientAddress": "string",
"ObjectID": 0,
"ObjectNumber": "string",
"ObjectName": "string",
"ObjectType": "string",
"GeneratingCustomer": true,
"ObjectAddress": "string",
"AgreementType": "string",
"AgreementModel": "string",
"AgreementFrom": "2020-09-21",
"AgreementTo": "2020-09-21",
"PermittablePowerConsumption": 0,
"PermittablePowerGeneration": 0,
"InstalledGeneratingPower": 0,
"InstalledConsumptionPower": 0,
"MetersAmount": 0,
"AutoMetersAmount": 0,
"ReportingPeriod": "2020-09-21",
"BillingPeriod": "2020-09-21",
"SupplyState": "string",
"SupplyStateFrom": "2020-09-21",
"SupplyStateTo": "2020-09-21",
"MetersNumber": "string",
"ReadingsSource": "string",
"ReadingsReceiveDate": "2020-09-21",
"PaymentType": "string",
"Service": "string",
"DeclarationReferenceType": "string",
"ReferenceSubmitDate": "2020-09-21",
"ReadingsSubmitDate": "2020-09-21",
"DeclarationReferenceNumber": 0,
"UnaccountedConsumptionActNumber": 0,
"UnaccountedConsumptionActCreateDate": "2020-09-21",
"UnaccountedConsumptionActFrom": "2020-09-21",
"UnaccountedConsumptionActTo": "2020-09-21",
"ConsumptionConversionActNumber": "string",
"ConsumptionConversionActCreateDate": "2020-09-21",
```

"ConsumptionConversionActFrom": "2020-09-21",
"ConsumptionConversionActTo": "2020-09-21",
"ConsumptionState": "string",
"ConsumptionStateFrom": "2020-09-21",
"ConsumptionStateTo": "2020-09-21",
"TariffPlan": "string",
"TariffPlanChangeDate": "2020-09-21",
"ConsumptionConversionAct": true,
"PowerPlantCapacityDateFrom": "2020-09-21",
"EnergyObtainedDateFrom": "2020-09-21",
"PowerPlantCapacityDateTo": "2020-09-21",
"EnergyObtainedDateTo": "2020-09-21",
"EnergyObtainedPowerKw": 0,
"OperatorGridElectricityPercent": 0,
"ClientGridElectricityPercent": 0,
"VkConsumptionAmount": 0,
"VkViapConsumptionAmount": 0,
"VkSppdConsumptionAmount": 0,
"DdConsumptionAmount": 0,
"DdViapConsumptionAmount": 0,
"DdSppdConsumptionAmount": 0,
"NkConsumptionAmount": 0,
"NkViapConsumptionAmount": 0,
"NkSppdConsumptionAmount": 0,
"N2ConsumptionAmount": 0,
"N2ViapConsumptionAmount": 0,
"N2SppdConsumptionAmount": 0,
"D1ConsumptionAmount": 0,
"D1ViapConsumptionAmount": 0,
"D1SppdConsumptionAmount": 0,
"D2ConsumptionAmount": 0,
"D2ViapConsumptionAmount": 0,
"D2SppdConsumptionAmount": 0,
"N1ConsumptionAmount": 0,
"N1ViapConsumptionAmount": 0,
"N1SppdConsumptionAmount": 0,
"VkConsumedElectricityConsumptionAmount": 0,
"DdConsumedElectricityConsumptionAmount": 0,
"NkConsumedElectricityConsumptionAmount": 0,
"N2ConsumedElectricityConsumptionAmount": 0,
"D1ConsumedElectricityConsumptionAmount": 0,
"D2ConsumedElectricityConsumptionAmount": 0,

"N1ConsumedElectricityConsumptionAmount": 0,
"VkPayingRecoveredEnergyConsumptionAmount": 0,
"DdPayingRecoveredEnergyConsumptionAmount": 0,
"NkPayingRecoveredEnergyConsumptionAmount": 0,
"N2PayingRecoveredEnergyConsumptionAmount": 0,
"D1PayingRecoveredEnergyConsumptionAmount": 0,
"D2PayingRecoveredEnergyConsumptionAmount": 0,
"N1PayingRecoveredEnergyConsumptionAmount": 0,
"VkPayingRecoveredPercentConsumptionAmount": 0,
"DdPayingRecoveredPercentConsumptionAmount": 0,
"NkPayingRecoveredPercentConsumptionAmount": 0,
"N2PayingRecoveredPercentConsumptionAmount": 0,
"D1PayingRecoveredPercentConsumptionAmount": 0,
"D2PayingRecoveredPercentConsumptionAmount": 0,
"N1PayingRecoveredPercentConsumptionAmount": 0,
"VkPayingRecoveredPowerConsumptionAmount": 0,
"DdPayingRecoveredPowerConsumptionAmount": 0,
"NkPayingRecoveredPowerConsumptionAmount": 0,
"N2PayingRecoveredPowerConsumptionAmount": 0,
"D1PayingRecoveredPowerConsumptionAmount": 0,
"D2PayingRecoveredPowerConsumptionAmount": 0,
"N1PayingRecoveredPowerConsumptionAmount": 0,
"VkPayingRecoveredMixedConsumptionAmount": 0,
"DdPayingRecoveredMixedConsumptionAmount": 0,
"NkPayingRecoveredMixedConsumptionAmount": 0,
"N2PayingRecoveredMixedConsumptionAmount": 0,
"D1PayingRecoveredMixedConsumptionAmount": 0,
"D2PayingRecoveredMixedConsumptionAmount": 0,
"N1PayingRecoveredMixedConsumptionAmount": 0,
"VkMissingEnergyConsumptionAmount": 0,
"VkMissingEnergyViapConsumptionAmount": 0,
"VkMissingEnergySppdConsumptionAmount": 0,
"DdMissingEnergyConsumptionAmount": 0,
"DdMissingEnergyViapConsumptionAmount": 0,
"DdMissingEnergySppdConsumptionAmount": 0,
"NkMissingEnergyConsumptionAmount": 0,
"NkMissingEnergyViapConsumptionAmount": 0,
"NkMissingEnergySppdConsumptionAmount": 0,
"N2MissingEnergyConsumptionAmount": 0,
"N2MissingEnergyViapConsumptionAmount": 0,
"N2MissingEnergySppdConsumptionAmount": 0,
"D1MissingEnergyConsumptionAmount": 0,

"D1MissingEnergyViapConsumptionAmount": 0,
"D1MissingEnergySppdConsumptionAmount": 0,
"D2MissingEnergyConsumptionAmount": 0,
"D2MissingEnergyViapConsumptionAmount": 0,
"D2MissingEnergySppdConsumptionAmount": 0,
"N1MissingEnergyConsumptionAmount": 0,
"N1MissingEnergyViapConsumptionAmount": 0,
"N1MissingEnergySppdConsumptionAmount": 0,
"GridSuppliedConsumptionAmount": 0,
"AccumulatedBeginningConsumptionAmount": 0,
"AccumulatedEndConsumptionAmount": 0,
"AccumulatedUploadedConsumptionAmount": 0,
"AccumulatedRaisedConsumptionAmount": 0,
"CompensatedConsumptionAmount": 0,
"OldIndependentSupplier": "string",
"PowerPlantCapacityConsumptionAmount": 0,
"EnergyObtainedConsumptionAmount": 0,
"OperatorGridElectricityConsumptionAmount": 0,
"ClientGridElectricityConsumptionAmount": 0,
"VkUnit": "string",
"VkViapUnit": "string",
"VkSppdUnit": "string",
"DdUnit": "string",
"DdViapUnit": "string",
"DdSppdUnit": "string",
"NkUnit": "string",
"NkViapUnit": "string",
"NkSppdUnit": "string",
"N2Unit": "string",
"N2ViapUnit": "string",
"N2SppdUnit": "string",
"D1Unit": "string",
"D1ViapUnit": "string",
"D1SppdUnit": "string",
"D2Unit": "string",
"D2ViapUnit": "string",
"D2SppdUnit": "string",
"N1Unit": "string",
"N1ViapUnit": "string",
"N1SppdUnit": "string",
"VkConsumedElectricityUnit": "string",
"DdConsumedElectricityUnit": "string",

"NkConsumedElectricityUnit": "string",
"N2ConsumedElectricityUnit": "string",
"D1ConsumedElectricityUnit": "string",
"D2ConsumedElectricityUnit": "string",
"N1ConsumedElectricityUnit": "string",
"VkPayingRecoveredEnergyUnit": "string",
"DdPayingRecoveredEnergyUnit": "string",
"NkPayingRecoveredEnergyUnit": "string",
"N2PayingRecoveredEnergyUnit": "string",
"D1PayingRecoveredEnergyUnit": "string",
"D2PayingRecoveredEnergyUnit": "string",
"N1PayingRecoveredEnergyUnit": "string",
"VkPayingRecoveredPercentUnit": "string",
"DdPayingRecoveredPercentUnit": "string",
"NkPayingRecoveredPercentUnit": "string",
"N2PayingRecoveredPercentUnit": "string",
"D1PayingRecoveredPercentUnit": "string",
"D2PayingRecoveredPercentUnit": "string",
"N1PayingRecoveredPercentUnit": "string",
"VkPayingRecoveredPowerUnit": "string",
"DdPayingRecoveredPowerUnit": "string",
"NkPayingRecoveredPowerUnit": "string",
"N2PayingRecoveredPowerUnit": "string",
"D1PayingRecoveredPowerUnit": "string",
"D2PayingRecoveredPowerUnit": "string",
"N1PayingRecoveredPowerUnit": "string",
"VkPayingRecoveredMixedUnit": "string",
"DdPayingRecoveredMixedUnit": "string",
"NkPayingRecoveredMixedUnit": "string",
"N2PayingRecoveredMixedUnit": "string",
"D1PayingRecoveredMixedUnit": "string",
"D2PayingRecoveredMixedUnit": "string",
"N1PayingRecoveredMixedUnit": "string",
"VkMissingEnergyUnit": "string",
"VkMissingEnergyViapUnit": "string",
"VkMissingEnergySppdUnit": "string",
"DdMissingEnergyUnit": "string",
"DdMissingEnergyViapUnit": "string",
"DdMissingEnergySppdUnit": "string",
"NkMissingEnergyUnit": "string",
"NkMissingEnergyViapUnit": "string",
"NkMissingEnergySppdUnit": "string",

"N2MissingEnergyUnit": "string",
"N2MissingEnergyViapUnit": "string",
"N2MissingEnergySppdUnit": "string",
"D1MissingEnergyUnit": "string",
"D1MissingEnergyViapUnit": "string",
"D1MissingEnergySppdUnit": "string",
"D2MissingEnergyUnit": "string",
"D2MissingEnergyViapUnit": "string",
"D2MissingEnergySppdUnit": "string",
"N1MissingEnergyUnit": "string",
"N1MissingEnergyViapUnit": "string",
"N1MissingEnergySppdUnit": "string",
"VkReadingsFrom": 0,
"DdReadingsFrom": 0,
"NkReadingsFrom": 0,
"N2ReadingsFrom": 0,
"D1ReadingsFrom": 0,
"D2ReadingsFrom": 0,
"N1ReadingsFrom": 0,
"VkConsumedElectricityReadingsFrom": 0,
"DdConsumedElectricityReadingsFrom": 0,
"NkConsumedElectricityReadingsFrom": 0,
"N2ConsumedElectricityReadingsFrom": 0,
"D1ConsumedElectricityReadingsFrom": 0,
"D2ConsumedElectricityReadingsFrom": 0,
"N1ConsumedElectricityReadingsFrom": 0,
"GridSuppliedReadingsFrom": 0,
"VkReadingsTo": 0,
"DdReadingsTo": 0,
"NkReadingsTo": 0,
"N2ReadingsTo": 0,
"D1ReadingsTo": 0,
"D2ReadingsTo": 0,
"N1ReadingsTo": 0,
"VkConsumedElectricityReadingsTo": 0,
"DdConsumedElectricityReadingsTo": 0,
"NkConsumedElectricityReadingsTo": 0,
"N2ConsumedElectricityReadingsTo": 0,
"D1ConsumedElectricityReadingsTo": 0,
"D2ConsumedElectricityReadingsTo": 0,
"N1ConsumedElectricityReadingsTo": 0,
"GridSuppliedReadingsTo": 0,

"VkPriceEur": 0,
"VkViapPriceEur": 0,
"VkSppdPriceEur": 0,
"DdPriceEur": 0,
"DdViapPriceEur": 0,
"DdSppdPriceEur": 0,
"NkPriceEur": 0,
"NkViapPriceEur": 0,
"NkSppdPriceEur": 0,
"N2PriceEur": 0,
"N2ViapPriceEur": 0,
"N2SppdPriceEur": 0,
"D1PriceEur": 0,
"D1ViapPriceEur": 0,
"D1SppdPriceEur": 0,
"D2PriceEur": 0,
"D2ViapPriceEur": 0,
"D2SppdPriceEur": 0,
"N1PriceEur": 0,
"N1ViapPriceEur": 0,
"N1SppdPriceEur": 0,
"VkPayingRecoveredEnergyPriceEur": 0,
"DdPayingRecoveredEnergyPriceEur": 0,
"NkPayingRecoveredEnergyPriceEur": 0,
"N2PayingRecoveredEnergyPriceEur": 0,
"D1PayingRecoveredEnergyPriceEur": 0,
"D2PayingRecoveredEnergyPriceEur": 0,
"N1PayingRecoveredEnergyPriceEur": 0,
"VkPayingRecoveredMixedPriceEur": 0,
"DdPayingRecoveredMixedPriceEur": 0,
"NkPayingRecoveredMixedPriceEur": 0,
"N2PayingRecoveredMixedPriceEur": 0,
"D1PayingRecoveredMixedPriceEur": 0,
"D2PayingRecoveredMixedPriceEur": 0,
"N1PayingRecoveredMixedPriceEur": 0,
"VkMissingEnergyPriceEur": 0,
"VkMissingEnergyViapPriceEur": 0,
"VkMissingEnergySppdPriceEur": 0,
"DdMissingEnergyPriceEur": 0,
"DdMissingEnergyViapPriceEur": 0,
"DdMissingEnergySppdPriceEur": 0,
"NkMissingEnergyPriceEur": 0,

"NkMissingEnergyViapPriceEur": 0,
"NkMissingEnergySppdPriceEur": 0,
"N2MissingEnergyPriceEur": 0,
"N2MissingEnergyViapPriceEur": 0,
"N2MissingEnergySppdPriceEur": 0,
"D1MissingEnergyPriceEur": 0,
"D1MissingEnergyViapPriceEur": 0,
"D1MissingEnergySppdPriceEur": 0,
"D2MissingEnergyPriceEur": 0,
"D2MissingEnergyViapPriceEur": 0,
"D2MissingEnergySppdPriceEur": 0,
"N1MissingEnergyPriceEur": 0,
"N1MissingEnergyViapPriceEur": 0,
"N1MissingEnergySppdPriceEur": 0,
"PowerPlantCapacityPriceEur": 0,
"VkPriceEurVAT": 0,
"VkViapPriceEurVAT": 0,
"VkSppdPriceEurVAT": 0,
"DdPriceEurVAT": 0,
"DdViapPriceEurVAT": 0,
"DdSppdPriceEurVAT": 0,
"NkPriceEurVAT": 0,
"NkViapPriceEurVAT": 0,
"NkSppdPriceEurVAT": 0,
"N2PriceEurVAT": 0,
"N2ViapPriceEurVAT": 0,
"N2SppdPriceEurVAT": 0,
"D1PriceEurVAT": 0,
"D1ViapPriceEurVAT": 0,
"D1SppdPriceEurVAT": 0,
"D2PriceEurVAT": 0,
"D2ViapPriceEurVAT": 0,
"D2SppdPriceEurVAT": 0,
"N1PriceEurVAT": 0,
"N1ViapPriceEurVAT": 0,
"N1SppdPriceEurVAT": 0,
"VkPayingRecoveredEnergyPriceEurVAT": 0,
"DdPayingRecoveredEnergyPriceEurVAT": 0,
"NkPayingRecoveredEnergyPriceEurVAT": 0,
"N2PayingRecoveredEnergyPriceEurVAT": 0,
"D1PayingRecoveredEnergyPriceEurVAT": 0,
"D2PayingRecoveredEnergyPriceEurVAT": 0,

"N1PayingRecoveredEnergyPriceEurVAT": 0,
"VkPayingRecoveredMixedPriceEurVAT": 0,
"DdPayingRecoveredMixedPriceEurVAT": 0,
"NkPayingRecoveredMixedPriceEurVAT": 0,
"N2PayingRecoveredMixedPriceEurVAT": 0,
"D1PayingRecoveredMixedPriceEurVAT": 0,
"D2PayingRecoveredMixedPriceEurVAT": 0,
"N1PayingRecoveredMixedPriceEurVAT": 0,
"VkMissingEnergyPriceEurVAT": 0,
"VkMissingEnergyViapPriceEurVAT": 0,
"VkMissingEnergySppdPriceEurVAT": 0,
"DdMissingEnergyPriceEurVAT": 0,
"DdMissingEnergyViapPriceEurVAT": 0,
"DdMissingEnergySppdPriceEurVAT": 0,
"NkMissingEnergyPriceEurVAT": 0,
"NkMissingEnergyViapPriceEurVAT": 0,
"NkMissingEnergySppdPriceEurVAT": 0,
"N2MissingEnergyPriceEurVAT": 0,
"N2MissingEnergyViapPriceEurVAT": 0,
"N2MissingEnergySppdPriceEurVAT": 0,
"D1MissingEnergyPriceEurVAT": 0,
"D1MissingEnergyViapPriceEurVAT": 0,
"D1MissingEnergySppdPriceEurVAT": 0,
"D2MissingEnergyPriceEurVAT": 0,
"D2MissingEnergyViapPriceEurVAT": 0,
"D2MissingEnergySppdPriceEurVAT": 0,
"N1MissingEnergyPriceEurVAT": 0,
"N1MissingEnergyViapPriceEurVAT": 0,
"N1MissingEnergySppdPriceEurVAT": 0,
"PowerPlantCapacityPriceEurVAT": 0,
"VkDiscount": 0,
"VkViapDiscount": 0,
"VkSppdDiscount": 0,
"DdDiscount": 0,
"DdViapDiscount": 0,
"DdSppdDiscount": 0,
"NkDiscount": 0,
"NkViapDiscount": 0,
"NkSppdDiscount": 0,
"N2Discount": 0,
"N2ViapDiscount": 0,
"N2SppdDiscount": 0,

"D1Discount": 0,
"D1ViapDiscount": 0,
"D1SppdDiscount": 0,
"D2Discount": 0,
"D2ViapDiscount": 0,
"D2SppdDiscount": 0,
"N1Discount": 0,
"N1ViapDiscount": 0,
"N1SppdDiscount": 0,
"VkPayingRecoveredEnergyDiscount": 0,
"VkPayingRecoveredMixedDiscount": 0,
"VkMissingEnergyDiscount": 0,
"VkMissingEnergyViapDiscount": 0,
"VkMissingEnergySppdDiscount": 0,
"FixedFeeAmountNoVAT": 0,
"VkAmountNoVAT": 0,
"VkViapAmountNoVAT": 0,
"VkSppdAmountNoVAT": 0,
"DdAmountNoVAT": 0,
"DdViapAmountNoVAT": 0,
"DdSppdAmountNoVAT": 0,
"NkAmountNoVAT": 0,
"NkViapAmountNoVAT": 0,
"NkSppdAmountNoVAT": 0,
"N2AmountNoVAT": 0,
"N2ViapAmountNoVAT": 0,
"N2SppdAmountNoVAT": 0,
"D1AmountNoVAT": 0,
"D1ViapAmountNoVAT": 0,
"D1SppdAmountNoVAT": 0,
"D2AmountNoVAT": 0,
"D2ViapAmountNoVAT": 0,
"D2SppdAmountNoVAT": 0,
"N1AmountNoVAT": 0,
"N1ViapAmountNoVAT": 0,
"N1SppdAmountNoVAT": 0,
"VkPayingRecoveredEnergyAmountNoVAT": 0,
"DdPayingRecoveredEnergyAmountNoVAT": 0,
"NkPayingRecoveredEnergyAmountNoVAT": 0,
"N2PayingRecoveredEnergyAmountNoVAT": 0,
"D1PayingRecoveredEnergyAmountNoVAT": 0,
"D2PayingRecoveredEnergyAmountNoVAT": 0,

"N1PayingRecoveredEnergyAmountNoVAT": 0,
"VkPayingRecoveredMixedAmountNoVAT": 0,
"DdPayingRecoveredMixedAmountNoVAT": 0,
"NkPayingRecoveredMixedAmountNoVAT": 0,
"N2PayingRecoveredMixedAmountNoVAT": 0,
"D1PayingRecoveredMixedAmountNoVAT": 0,
"D2PayingRecoveredMixedAmountNoVAT": 0,
"N1PayingRecoveredMixedAmountNoVAT": 0,
"VkMissingEnergyAmountNoVAT": 0,
"VkMissingEnergyViapAmountNoVAT": 0,
"VkMissingEnergySppdAmountNoVAT": 0,
"DdMissingEnergyAmountNoVAT": 0,
"DdMissingEnergyViapAmountNoVAT": 0,
"DdMissingEnergySppdAmountNoVAT": 0,
"NkMissingEnergyAmountNoVAT": 0,
"NkMissingEnergyViapAmountNoVAT": 0,
"NkMissingEnergySppdAmountNoVAT": 0,
"N2MissingEnergyAmountNoVAT": 0,
"N2MissingEnergyViapAmountNoVAT": 0,
"N2MissingEnergySppdAmountNoVAT": 0,
"D1MissingEnergyAmountNoVAT": 0,
"D1MissingEnergyViapAmountNoVAT": 0,
"D1MissingEnergySppdAmountNoVAT": 0,
"D2MissingEnergyAmountNoVAT": 0,
"D2MissingEnergyViapAmountNoVAT": 0,
"D2MissingEnergySppdAmountNoVAT": 0,
"N1MissingEnergyAmountNoVAT": 0,
"N1MissingEnergyViapAmountNoVAT": 0,
"N1MissingEnergySppdAmountNoVAT": 0,
"PowerPlantCapacityAmountNoVAT": 0,
"FixedFeeAmount": 0,
"VkAmount": 0,
"VkViapAmount": 0,
"VkSppdAmount": 0,
"DdAmount": 0,
"DdViapAmount": 0,
"DdSppdAmount": 0,
"NkAmount": 0,
"NkViapAmount": 0,
"NkSppdAmount": 0,
"N2Amount": 0,
"N2ViapAmount": 0,

"N2SppdAmount": 0,
"D1Amount": 0,
"D1ViapAmount": 0,
"D1SppdAmount": 0,
"D2Amount": 0,
"D2ViapAmount": 0,
"D2SppdAmount": 0,
"N1Amount": 0,
"N1ViapAmount": 0,
"N1SppdAmount": 0,
"VkPayingRecoveredEnergyAmount": 0,
"DdPayingRecoveredEnergyAmount": 0,
"NkPayingRecoveredEnergyAmount": 0,
"N2PayingRecoveredEnergyAmount": 0,
"D1PayingRecoveredEnergyAmount": 0,
"D2PayingRecoveredEnergyAmount": 0,
"N1PayingRecoveredEnergyAmount": 0,
"VkPayingRecoveredMixedAmount": 0,
"DdPayingRecoveredMixedAmount": 0,
"NkPayingRecoveredMixedAmount": 0,
"N2PayingRecoveredMixedAmount": 0,
"D1PayingRecoveredMixedAmount": 0,
"D2PayingRecoveredMixedAmount": 0,
"N1PayingRecoveredMixedAmount": 0,
"VkMissingEnergyAmount": 0,
"VkMissingEnergyViapAmount": 0,
"VkMissingEnergySppdAmount": 0,
"DdMissingEnergyAmount": 0,
"DdMissingEnergyViapAmount": 0,
"DdMissingEnergySppdAmount": 0,
"NkMissingEnergyAmount": 0,
"NkMissingEnergyViapAmount": 0,
"NkMissingEnergySppdAmount": 0,
"N2MissingEnergyAmount": 0,
"N2MissingEnergyViapAmount": 0,
"N2MissingEnergySppdAmount": 0,
"D1MissingEnergyAmount": 0,
"D1MissingEnergyViapAmount": 0,
"D1MissingEnergySppdAmount": 0,
"D2MissingEnergyAmount": 0,
"D2MissingEnergyViapAmount": 0,
"D2MissingEnergySppdAmount": 0,

"N1MissingEnergyAmount": 0,
"N1MissingEnergyViapAmount": 0,
"N1MissingEnergySppdAmount": 0,
"PowerPlantCapacityAmount": 0,
"FixedFeeIncludedVAT": "string",
"VkIncludedVAT": "string",
"VkViapIncludedVAT": "string",
"VkSppdIncludedVAT": "string",
"DdIncludedVAT": "string",
"DdViapIncludedVAT": "string",
"DdSppdIncludedVAT": "string",
"NkIncludedVAT": "string",
"NkViapIncludedVAT": "string",
"NkSppdIncludedVAT": "string",
"N2IncludedVAT": "string",
"N2ViapIncludedVAT": "string",
"N2SppdIncludedVAT": "string",
"D1IncludedVAT": "string",
"D1ViapIncludedVAT": "string",
"D1SppdIncludedVAT": "string",
"D2IncludedVAT": "string",
"D2ViapIncludedVAT": "string",
"D2SppdIncludedVAT": "string",
"N1IncludedVAT": "string",
"N1ViapIncludedVAT": "string",
"N1SppdIncludedVAT": "string",
"VkPayingRecoveredEnergyIncludedVAT": "string",
"DdPayingRecoveredEnergyIncludedVAT": "string",
"NkPayingRecoveredEnergyIncludedVAT": "string",
"N2PayingRecoveredEnergyIncludedVAT": "string",
"D1PayingRecoveredEnergyIncludedVAT": "string",
"D2PayingRecoveredEnergyIncludedVAT": "string",
"N1PayingRecoveredEnergyIncludedVAT": "string",
"VkPayingRecoveredMixedIncludedVAT": "string",
"DdPayingRecoveredMixedIncludedVAT": "string",
"NkPayingRecoveredMixedIncludedVAT": "string",
"N2PayingRecoveredMixedIncludedVAT": "string",
"D1PayingRecoveredMixedIncludedVAT": "string",
"D2PayingRecoveredMixedIncludedVAT": "string",
"N1PayingRecoveredMixedIncludedVAT": "string",
"VkMissingEnergyIncludedVAT": "string",
"VkMissingEnergyViapIncludedVAT": "string",

```

"VkMissingEnergySppdIncludedVAT": "string",
"DdMissingEnergyIncludedVAT": "string",
"DdMissingEnergyViapIncludedVAT": "string",
"DdMissingEnergySppdIncludedVAT": "string",
"NkMissingEnergyIncludedVAT": "string",
"NkMissingEnergyViapIncludedVAT": "string",
"NkMissingEnergySppdIncludedVAT": "string",
"N2MissingEnergyIncludedVAT": "string",
"N2MissingEnergyViapIncludedVAT": "string",
"N2MissingEnergySppdIncludedVAT": "string",
"D1MissingEnergyIncludedVAT": "string",
"D1MissingEnergyViapIncludedVAT": "string",
"D1MissingEnergySppdIncludedVAT": "string",
"D2MissingEnergyIncludedVAT": "string",
"D2MissingEnergyViapIncludedVAT": "string",
"D2MissingEnergySppdIncludedVAT": "string",
"N1MissingEnergyIncludedVAT": "string",
"N1MissingEnergyViapIncludedVAT": "string",
"N1MissingEnergySppdIncludedVAT": "string",
"PowerPlantCapacityIncludedVAT": "string",
"PowerPlantCapacityUnit": "string"
}
]

```

| Attribute | type | obligation | description |
|-----------|------|------------|---|
| - | - | - | Response description are provided in additional documentation . In next document version, all fields description will be provided here. |

Below are the error codes and messages. Response codes and response content in case of error:

7.11.1.3 Response Error codes

| Code | Message | Explanation |
|------|--|--|
| 1. | Currently accounting data are not complete and it will be generated within 5 working days. You will be informed separately as soon as data will be complete and ready for a use. | - |
| 1004 | The value of the count parameter must be less or equal to 10 000. | The value of the count parameter cannot be above 10 000. |

7.11.2 POST /reports/accounting-data-pack-b2c-count

| | | | |
|---------------------|---|-------------------------|---|
| URI | POST /reports/accounting-data-pack-b2c-count | | |
| Description | Method which will return count (number), how many items Supplier will get in „POST /reports/accounting-data-pack-b2c“ report (reports could have more than 1 item, so it is List). It should be used when supplier need to split data in few portions. This response should be used in „POST /reports/accounting-data-pack-b2c“ method request, where Supplier can provide method parameters information. | | |
| Parameters | none | | |
| Request Body | Data order must be submitted in HTTP request body in a form of JSON | | |
| Response | HTTP status code | Reason | Response description |
| | 201 | Created | Request completed successfully |
| | 400 | Bad Request | Request error. The HTTP response body provides a list of errors in JSON format. |
| | 401 | Unauthorized | An attempt was made to connect to a non-public method that requires authentication, but no user credentials were provided. |
| | 403 | Forbidden | According to the access control policy, the current user does not have access to perform the requested action. |
| | 404 | Not Found | Either there is no API method associated with the request URL path, or the request contains one or more parameters that did not return the data. |
| | 423 | Locked | The source or destination resource of a method is locked. This response SHOULD contain an appropriate precondition or postcondition code, such as 'lock-token-submitted' or 'no-conflicting-lock'. |
| Rules | No. | Rule description | Attributes |

| | | | |
|--|----|---|---------------------------------------|
| | 0. | If an attribute has defined possible values, the value index can be specified by specifying the value of the attribute in the request. Indices of all possible values start from 0. | All attributes with specified values. |
| | 1. | Counts report list items and return SUM of all report lines | - |
| | 2. | The operator does not provide interim data. The operator provides only final / complete data. | - |

7.11.2.1 JSON Request structure

| JSON Request structure | | | |
|---|------------|--------------|---|
| <pre>{ "customerCode": "string", "dateFrom": "date", "dateTo": "date", "objectNo": "string" }</pre> | | | |
| Attribute | type | obligation | description |
| customerCode | String(32) | not required | User code of contracted customer |
| dateFrom | Date | required | Date from which data from DSO Billing system should be included into report |
| dateTo | Date | required | Date to which data from DSO Billing system should be included into report |
| objectNo | String(20) | not required | Object Number of the object for the supply of electricity in which the contract is concluded. |

7.11.2.2 JSON Response structure

| JSON Response structure | | | |
|----------------------------------|------|------------|-------------|
| <pre>{ "count": "number" }</pre> | | | |
| Attribute | type | obligation | description |

| | | | |
|-------|------------|----------|--|
| count | number(10) | required | Returns number, how many items are in report items list. This response can be used in accounting-data-pack-b2c report parameters to split data in few response portions (if need pagination) |
|-------|------------|----------|--|

Below are the error codes and messages. Response codes and response content in case of error:

7.11.2.3 Response Error codes

| Code | Message | Explanation |
|------|--|-------------|
| 1. | Currently accounting data are not complete and it will be generated within 5 working days. You will be informed separately as soon as data will be complete and ready for a use. | - |

7.11.3 POST /reports/accounting-data-pack-b2b-meters-level?first={integer}&count={integer}

| | | | |
|---------------------|--|---------------|---|
| URI | POST /reports/accounting-data-pack-b2b-meters-level?first={integer}&count={integer} | | |
| Description | Report which will return accounting data in meter level for Business clients. If business client object has two meters, this method will return list of two items. | | |
| Parameters | URL parameters: first - the index of the report line, which must be the first in the return list (starting from 0). Optional. The default value is 0. count - the number of report rows in the return list. Optional. The default value is 30. | | |
| Request Body | Data order must be submitted in HTTP request body in a form of JSON | | |
| Response | HTTP status code | Reason | Response description |
| | 201 | Created | Request completed successfully |
| | 400 | Bad Request | Request error. The HTTP response body provides a list of errors in JSON format. |

| | | | |
|--------------|------------|--|---|
| | 401 | Unauthorized | An attempt was made to connect to a non-public method that requires authentication, but no user credentials were provided. |
| | 403 | Forbidden | According to the access control policy, the current user does not have access to perform the requested action. |
| | 404 | Not Found | Either there is no API method associated with the request URL path, or the request contains one or more parameters that did not return the data. |
| | 423 | Locked | The source or destination resource of a method is locked. This response SHOULD contain an appropriate precondition or postcondition code, such as 'lock-token-submitted' or 'no-conflicting-lock'. |
| Rules | No. | Rule description | Attributes |
| | 0. | If an attribute has defined possible values, the value index can be specified by specifying the value of the attribute in the request. Indices of all possible values start from 0. | All attributes with specified values. |
| | 1. | The value of the count parameter cannot be above 10 000. If the error occurs the error message 1004 will be displayed. | count |
| | 2. | Depending on the dateFrom and dateTo fields specified in the request, the request is executed and the report data is selected and submitted. If only date fields are specified, then the report returns information about all objects in all customer contracts. | dateFrom, dateTo |
| | 3. | Depending on the dateFrom and dateTo fields specified in the request, the request is executed and the report data is selected and submitted. If date fields and customerCode are specified, then the report returns information about all objects in provided customer contract. | dateFrom, dateTo, customerCode |
| | 4. | Depending on the dateFrom and dateTo fields specified in the request, the request is executed and the report data is selected and submitted. If date fields, | dateFrom, dateTo, customerCode, objectNo |

| | | | |
|--|----|---|---|
| | | customerCode and objectNo are specified, then the report returns information about provided object in provided customer contract. | |
| | 5. | The operator does not provide interim data. The operator provides only final / complete data. | - |

7.11.3.1 JSON Request structure

JSON Request structure

```
{
  "customerCode": "string",
  "dateFrom": "date",
  "dateTo": "date",
  "objectNo": "string"
}
```

| Attribute | type | obligation | description |
|--------------|------------|--------------|---|
| customerCode | String(32) | not required | User code of contracted customer |
| dateFrom | Date | required | Date from which data from DSO Billing system should be included into report |
| dateTo | Date | required | Date to which data from DSO Billing system should be included into report |
| objectNo | String(20) | not required | Object Number of the object for the supply of electricity in which the contract is concluded. |

The table below describes URL request attributes:

| Attribute | type | obligation | description |
|-----------|---------|--------------|--|
| first | integer | not required | Index (starting from 0) of the object that must be presented first in the return list. |
| count | integer | not required | Number of objects in the return list. |

7.11.3.2 JSON Response structure

JSON Response structure

```
[
{
"CustomerID": 0,
"ClientID": "string",
"ClientName": "string",
"ClientAddress": "string",
"ObjectID": 0,
"ObjectNumber": "string",
"ObjectName": "string",
"ObjectType": "string",
"GeneratingCustomer": true,
"ObjectAddress": "string",
"AgreementType": "string",
"AgreementModel": "string",
"AgreementFrom": 0,
"AgreementTo": 0,
"PermittablePowerConsumption": 0,
"PermittablePowerGeneration": 0,
"InstalledGeneratingPower": 0,
"InstalledConsumptionPower": 0,
"MetersAmount": 0,
"AutoMetersAmount": 0,
"ReportingPeriod": "2020-09-02",
"BillingPeriod": "2020-09-02",
"SupplyState": "string",
"SupplyStateFrom": "2020-09-02",
"SupplyStateTo": "2020-09-02",
"MetersNumber": "string",
"ReadingsSource": "string",
"ReadingsReceiveDate": "2020-09-02",
"PaymentType": "string",
"DeclarationReferenceType": "string",
"Service": "string",
"ReferenceSubmitDate": "2020-09-02",
"ReadingsSubmitDate": "2020-09-02",
"DeclarationReferenceNumber": 0,
"UnaccountedConsumptionActNumber": 0,
"UnaccountedConsumptionActCreateDate": "2020-09-02",
"UnaccountedConsumptionActFrom": "2020-09-02",
"UnaccountedConsumptionActTo": "2020-09-02",
"ConsumptionConversionActNumber": "string",
"ConsumptionConversionActCreateDate": "2020-09-02",
```

"ConsumptionConversionActFrom": "2020-09-02",
"ConsumptionConversionActTo": "2020-09-02",
"ConsumptionState": "string",
"ConsumptionStateFrom": "2020-09-02",
"ConsumptionStateTo": "2020-09-02",
"TariffPlan": "string",
"PowerPlantCapacityDateFrom": "2020-09-02",
"EnergyObtainedDateFrom": "2020-09-02",
"PowerPlantCapacityDateTo": "2020-09-02",
"PowerPlantCapacitySource": "string",
"PowerPlantCapacitySourceDateFrom": "2020-09-02",
"PowerPlantCapacitySourceDateTo": "2020-09-02",
"EnergyObtainedDateTo": "2020-09-02",
"EnergyObtainedPowerKw": 0,
"TariffPlanChangeDate": "2020-09-02",
"ConsumptionConversionAct": true,
"UnaccountedAct": true,
"ConversionAct": true,
"OperatorGridElectricityPercent": 0,
"ClientGridElectricityPercent": 0,
"GaConsumptionAmount": 0,
"VkConsumptionAmount": 0,
"VkViapConsumptionAmount": 0,
"VkSppdConsumptionAmount": 0,
"VkDiscountConsumptionAmount": 0,
"DdConsumptionAmount": 0,
"DdViapConsumptionAmount": 0,
"DdSppdConsumptionAmount": 0,
"DdDiscountConsumptionAmount": 0,
"NkConsumptionAmount": 0,
"NkViapConsumptionAmount": 0,
"NkSppdConsumptionAmount": 0,
"NkDiscountConsumptionAmount": 0,
"MaConsumptionAmount": 0,
"MaViapConsumptionAmount": 0,
"VdConsumptionAmount": 0,
"VdViapConsumptionAmount": 0,
"SvConsumptionAmount": 0,
"SvViapConsumptionAmount": 0,
"MiConsumptionAmount": 0,
"MiViapConsumptionAmount": 0,
"RvConsumptionAmount": 0,

"RgConsumptionAmount": 0,
"VgConsumptionAmount": 0,
"Reliability1ConsumptionAmount": 0,
"Reliability2ConsumptionAmount": 0,
"Reliability3ConsumptionAmount": 0,
"TechnologicalCostsViapConsumptionAmount": 0,
"TechnologicalCostsConsumptionAmount": 0,
"GeneralInterestConsumptionAmount": 0,
"VkConsumedElectricityConsumptionAmount": 0,
"DdConsumedElectricityConsumptionAmount": 0,
"NkConsumedElectricityConsumptionAmount": 0,
"MaConsumedElectricityConsumptionAmount": 0,
"VdConsumedElectricityConsumptionAmount": 0,
"SvConsumedElectricityConsumptionAmount": 0,
"MiConsumedElectricityConsumptionAmount": 0,
"VkPayingRecoveredEnergyConsumptionAmount": 0,
"DdPayingRecoveredEnergyConsumptionAmount": 0,
"NkPayingRecoveredEnergyConsumptionAmount": 0,
"MaPayingRecoveredEnergyConsumptionAmount": 0,
"VdPayingRecoveredEnergyConsumptionAmount": 0,
"SvPayingRecoveredEnergyConsumptionAmount": 0,
"MiPayingRecoveredEnergyConsumptionAmount": 0,
"VkPayingRecoveredPercentConsumptionAmount": 0,
"DdPayingRecoveredPercentConsumptionAmount": 0,
"NkPayingRecoveredPercentConsumptionAmount": 0,
"MaPayingRecoveredPercentConsumptionAmount": 0,
"VdPayingRecoveredPercentConsumptionAmount": 0,
"SvPayingRecoveredPercentConsumptionAmount": 0,
"MiPayingRecoveredPercentConsumptionAmount": 0,
"VkPayingRecoveredPowerConsumptionAmount": 0,
"DdPayingRecoveredPowerConsumptionAmount": 0,
"NkPayingRecoveredPowerConsumptionAmount": 0,
"MaPayingRecoveredPowerConsumptionAmount": 0,
"VdPayingRecoveredPowerConsumptionAmount": 0,
"SvPayingRecoveredPowerConsumptionAmount": 0,
"MiPayingRecoveredPowerConsumptionAmount": 0,
"VkPayingRecoveredMixedConsumptionAmount": 0,
"DdPayingRecoveredMixedConsumptionAmount": 0,
"NkPayingRecoveredMixedConsumptionAmount": 0,
"MaPayingRecoveredMixedConsumptionAmount": 0,
"VdPayingRecoveredMixedConsumptionAmount": 0,
"SvPayingRecoveredMixedConsumptionAmount": 0,

"MiPayingRecoveredMixedConsumptionAmount": 0,
"VkMissingEnergyConsumptionAmount": 0,
"VkMissingEnergyViapConsumptionAmount": 0,
"VkMissingEnergySppdConsumptionAmount": 0,
"DdMissingEnergyConsumptionAmount": 0,
"DdMissingEnergyViapConsumptionAmount": 0,
"DdMissingEnergySppdConsumptionAmount": 0,
"NkMissingEnergyConsumptionAmount": 0,
"NkMissingEnergyViapConsumptionAmount": 0,
"NkMissingEnergySppdConsumptionAmount": 0,
"MaMissingEnergyConsumptionAmount": 0,
"MaMissingEnergyViapConsumptionAmount": 0,
"VdMissingEnergyConsumptionAmount": 0,
"VdMissingEnergyViapConsumptionAmount": 0,
"SvMissingEnergyConsumptionAmount": 0,
"SvMissingEnergyViapConsumptionAmount": 0,
"MiMissingEnergyConsumptionAmount": 0,
"MiMissingEnergyViapConsumptionAmount": 0,
"VkMissingEnergyDiscountConsumptionAmount": 0,
"DdMissingEnergyDiscountConsumptionAmount": 0,
"NkMissingEnergyDiscountConsumptionAmount": 0,
"GridSuppliedConsumptionAmount": 0,
"AccumulatedBeginningConsumptionAmount": 0,
"AccumulatedEndConsumptionAmount": 0,
"AccumulatedUploadedConsumptionAmount": 0,
"AccumulatedRaisedConsumptionAmount": 0,
"CompensatedConsumptionAmount": 0,
"OldIndependentSupplier": "string",
"PowerPlantCapacityConsumptionAmount": 0,
"EnergyObtainedConsumptionAmount": 0,
"OperatorGridElectricityConsumptionAmount": 0,
"ClientGridElectricityConsumptionAmount": 0,
"PowerPlantCapacityUnit": "string",
"GaUnit": "string",
"VkUnit": "string",
"VkViapUnit": "string",
"VkSppdUnit": "string",
"VkDiscountUnit": "string",
"DdUnit": "string",
"DdViapUnit": "string",
"DdSppdUnit": "string",
"DdDiscountUnit": "string",

"NkUnit": "string",
"NkViapUnit": "string",
"NkSppdUnit": "string",
"NkDiscountUnit": "string",
"MaUnit": "string",
"MaViapUnit": "string",
"VdUnit": "string",
"VdViapUnit": "string",
"SvUnit": "string",
"SvViapUnit": "string",
"MiUnit": "string",
"MiViapUnit": "string",
"RvUnit": "string",
"RgUnit": "string",
"VgUnit": "string",
"Reliability1Unit": "string",
"Reliability2Unit": "string",
"Reliability3Unit": "string",
"TechnologicalCostsViapUnit": "string",
"TechnologicalCostsUnit": "string",
"GeneralInterestUnit": "string",
"VkConsumedElectricityUnit": "string",
"DdConsumedElectricityUnit": "string",
"NkConsumedElectricityUnit": "string",
"MaConsumedElectricityUnit": "string",
"VdConsumedElectricityUnit": "string",
"SvConsumedElectricityUnit": "string",
"MiConsumedElectricityUnit": "string",
"VkPayingRecoveredEnergyUnit": "string",
"DdPayingRecoveredEnergyUnit": "string",
"NkPayingRecoveredEnergyUnit": "string",
"MaPayingRecoveredEnergyUnit": "string",
"VdPayingRecoveredEnergyUnit": "string",
"SvPayingRecoveredEnergyUnit": "string",
"MiPayingRecoveredEnergyUnit": "string",
"VkPayingRecoveredPercentUnit": "string",
"DdPayingRecoveredPercentUnit": "string",
"NkPayingRecoveredPercentUnit": "string",
"MaPayingRecoveredPercentUnit": "string",
"VdPayingRecoveredPercentUnit": "string",
"SvPayingRecoveredPercentUnit": "string",
"MiPayingRecoveredPercentUnit": "string",

"VkPayingRecoveredPowerUnit": "string",
"DdPayingRecoveredPowerUnit": "string",
"NkPayingRecoveredPowerUnit": "string",
"MaPayingRecoveredPowerUnit": "string",
"VdPayingRecoveredPowerUnit": "string",
"SvPayingRecoveredPowerUnit": "string",
"MiPayingRecoveredPowerUnit": "string",
"VkPayingRecoveredMixedUnit": "string",
"DdPayingRecoveredMixedUnit": "string",
"NkPayingRecoveredMixedUnit": "string",
"MaPayingRecoveredMixedUnit": "string",
"VdPayingRecoveredMixedUnit": "string",
"SvPayingRecoveredMixedUnit": "string",
"MiPayingRecoveredMixedUnit": "string",
"VkMissingEnergyUnit": "string",
"VkMissingEnergyViapUnit": "string",
"VkMissingEnergySppdUnit": "string",
"DdMissingEnergyUnit": "string",
"DdMissingEnergyViapUnit": "string",
"DdMissingEnergySppdUnit": "string",
"NkMissingEnergyUnit": "string",
"NkMissingEnergyViapUnit": "string",
"NkMissingEnergySppdUnit": "string",
"MaMissingEnergyUnit": "string",
"MaMissingEnergyViapUnit": "string",
"VdMissingEnergyUnit": "string",
"VdMissingEnergyViapUnit": "string",
"SvMissingEnergyUnit": "string",
"SvMissingEnergyViapUnit": "string",
"MiMissingEnergyUnit": "string",
"MiMissingEnergyViapUnit": "string",
"VkMissingEnergyDiscountUnit": "string",
"DdMissingEnergyDiscountUnit": "string",
"NkMissingEnergyDiscountUnit": "string",
"VkReadingsFrom": 0,
"DdReadingsFrom": 0,
"NkReadingsFrom": 0,
"MaReadingsFrom": 0,
"VdReadingsFrom": 0,
"SvReadingsFrom": 0,
"MiReadingsFrom": 0,
"RvReadingsFrom": 0,

"RgReadingsFrom": 0,
"VkConsumedElectricityReadingsFrom": 0,
"DdConsumedElectricityReadingsFrom": 0,
"NkConsumedElectricityReadingsFrom": 0,
"MaConsumedElectricityReadingsFrom": 0,
"VdConsumedElectricityReadingsFrom": 0,
"SvConsumedElectricityReadingsFrom": 0,
"MiConsumedElectricityReadingsFrom": 0,
"GridSuppliedReadingsFrom": 0,
"VkReadingsTo": 0,
"DdReadingsTo": 0,
"NkReadingsTo": 0,
"MaReadingsTo": 0,
"VdReadingsTo": 0,
"SvReadingsTo": 0,
"MiReadingsTo": 0,
"RvReadingsTo": 0,
"RgReadingsTo": 0,
"VkConsumedElectricityReadingsTo": 0,
"DdConsumedElectricityReadingsTo": 0,
"NkConsumedElectricityReadingsTo": 0,
"MaConsumedElectricityReadingsTo": 0,
"VdConsumedElectricityReadingsTo": 0,
"SvConsumedElectricityReadingsTo": 0,
"MiConsumedElectricityReadingsTo": 0,
"GridSuppliedReadingsTo": 0,
"GaPriceEur": 0,
"VkPriceEur": 0,
"VkViapPriceEur": 0,
"VkSppdPriceEur": 0,
"VkDiscountPriceEur": 0,
"DdPriceEur": 0,
"DdViapPriceEur": 0,
"DdSppdPriceEur": 0,
"DdDiscountPriceEur": 0,
"NkPriceEur": 0,
"NkViapPriceEur": 0,
"NkSppdPriceEur": 0,
"NkDiscountPriceEur": 0,
"MaPriceEur": 0,
"MaViapPriceEur": 0,
"VdPriceEur": 0,

"VdViapPriceEur": 0,
"SvPriceEur": 0,
"SvViapPriceEur": 0,
"MiPriceEur": 0,
"MiViapPriceEur": 0,
"RvPriceEur": 0,
"RgPriceEur": 0,
"VgPriceEur": 0,
"Reliability1PriceEur": 0,
"Reliability2PriceEur": 0,
"Reliability3PriceEur": 0,
"TechnologicalCostsViapPriceEur": 0,
"TechnologicalCostsPriceEur": 0,
"GeneralInterestPriceEur": 0,
"VkPayingRecoveredEnergyPriceEur": 0,
"DdPayingRecoveredEnergyPriceEur": 0,
"NkPayingRecoveredEnergyPriceEur": 0,
"MaPayingRecoveredEnergyPriceEur": 0,
"VdPayingRecoveredEnergyPriceEur": 0,
"SvPayingRecoveredEnergyPriceEur": 0,
"MiPayingRecoveredEnergyPriceEur": 0,
"VkPayingRecoveredMixedPriceEur": 0,
"DdPayingRecoveredMixedPriceEur": 0,
"NkPayingRecoveredMixedPriceEur": 0,
"MaPayingRecoveredMixedPriceEur": 0,
"VdPayingRecoveredMixedPriceEur": 0,
"SvPayingRecoveredMixedPriceEur": 0,
"MiPayingRecoveredMixedPriceEur": 0,
"VkMissingEnergyPriceEur": 0,
"VkMissingEnergyViapPriceEur": 0,
"VkMissingEnergySppdPriceEur": 0,
"DdMissingEnergyPriceEur": 0,
"DdMissingEnergyViapPriceEur": 0,
"DdMissingEnergySppdPriceEur": 0,
"NkMissingEnergyPriceEur": 0,
"NkMissingEnergyViapPriceEur": 0,
"NkMissingEnergySppdPriceEur": 0,
"MaMissingEnergyPriceEur": 0,
"MaMissingEnergyViapPriceEur": 0,
"VdMissingEnergyPriceEur": 0,
"VdMissingEnergyViapPriceEur": 0,
"SvMissingEnergyPriceEur": 0,

"SvMissingEnergyViapPriceEur": 0,
"MiMissingEnergyPriceEur": 0,
"MiMissingEnergyViapPriceEur": 0,
"VkMissingEnergyDiscountPriceEur": 0,
"DdMissingEnergyDiscountPriceEur": 0,
"NkMissingEnergyDiscountPriceEur": 0,
"PowerPlantCapacityPriceEur": 0,
"GaDiscount": 0,
"VkDiscount": 0,
"VkViapDiscount": 0,
"VkSppdDiscount": 0,
"VkDiscountDiscount": 0,
"DdDiscount": 0,
"DdViapDiscount": 0,
"DdSppdDiscount": 0,
"DdDiscountDiscount": 0,
"NkDiscount": 0,
"NkViapDiscount": 0,
"NkSppdDiscount": 0,
"NkDiscountDiscount": 0,
"MaDiscount": 0,
"MaViapDiscount": 0,
"VdDiscount": 0,
"VdViapDiscount": 0,
"SvDiscount": 0,
"SvViapDiscount": 0,
"MiDiscount": 0,
"MiViapDiscount": 0,
"RvDiscount": 0,
"RgDiscount": 0,
"VgDiscount": 0,
"Reliability1Discount": 0,
"Reliability2Discount": 0,
"Reliability3Discount": 0,
"TechnologicalCostsViapDiscount": 0,
"TechnologicalCostsDiscount": 0,
"GeneralInterestDiscount": 0,
"VkPayingRecoveredEnergyDiscount": 0,
"VkPayingRecoveredMixedDiscount": 0,
"VkMissingEnergyDiscount": 0,
"VkMissingEnergyViapDiscount": 0,
"VkMissingEnergySppdDiscount": 0,

"VkMissingEnergyDiscountDiscount": 0,
"GaAmountNoVAT": 0,
"VkAmountNoVAT": 0,
"VkViapAmountNoVAT": 0,
"VkSppdAmountNoVAT": 0,
"VkDiscountAmountNoVAT": 0,
"DdAmountNoVAT": 0,
"DdViapAmountNoVAT": 0,
"DdSppdAmountNoVAT": 0,
"DdDiscountAmountNoVAT": 0,
"NkAmountNoVAT": 0,
"NkViapAmountNoVAT": 0,
"NkSppdAmountNoVAT": 0,
"NkDiscountAmountNoVAT": 0,
"MaAmountNoVAT": 0,
"MaViapAmountNoVAT": 0,
"VdAmountNoVAT": 0,
"VdViapAmountNoVAT": 0,
"SvAmountNoVAT": 0,
"SvViapAmountNoVAT": 0,
"MiAmountNoVAT": 0,
"MiViapAmountNoVAT": 0,
"RvAmountNoVAT": 0,
"RgAmountNoVAT": 0,
"VgAmountNoVAT": 0,
"Reliability1AmountNoVAT": 0,
"Reliability2AmountNoVAT": 0,
"Reliability3AmountNoVAT": 0,
"TechnologicalCostsViapAmountNoVAT": 0,
"TechnologicalCostsAmountNoVAT": 0,
"GeneralInterestAmountNoVAT": 0,
"VkPayingRecoveredEnergyAmountNoVAT": 0,
"DdPayingRecoveredEnergyAmountNoVAT": 0,
"NkPayingRecoveredEnergyAmountNoVAT": 0,
"MaPayingRecoveredEnergyAmountNoVAT": 0,
"VdPayingRecoveredEnergyAmountNoVAT": 0,
"SvPayingRecoveredEnergyAmountNoVAT": 0,
"MiPayingRecoveredEnergyAmountNoVAT": 0,
"VkPayingRecoveredMixedAmountNoVAT": 0,
"DdPayingRecoveredMixedAmountNoVAT": 0,
"NkPayingRecoveredMixedAmountNoVAT": 0,
"MaPayingRecoveredMixedAmountNoVAT": 0,

```

"VdPayingRecoveredMixedAmountNoVAT": 0,
"SvPayingRecoveredMixedAmountNoVAT": 0,
"MiPayingRecoveredMixedAmountNoVAT": 0,
"VkMissingEnergyAmountNoVAT": 0,
"VkMissingEnergyViapAmountNoVAT": 0,
"VkMissingEnergySppdAmountNoVAT": 0,
"DdMissingEnergyAmountNoVAT": 0,
"DdMissingEnergyViapAmountNoVAT": 0,
"DdMissingEnergySppdAmountNoVAT": 0,
"NkMissingEnergyAmountNoVAT": 0,
"NkMissingEnergyViapAmountNoVAT": 0,
"NkMissingEnergySppdAmountNoVAT": 0,
"MaMissingEnergyAmountNoVAT": 0,
"MaMissingEnergyViapAmountNoVAT": 0,
"VdMissingEnergyAmountNoVAT": 0,
"VdMissingEnergyViapAmountNoVAT": 0,
"SvMissingEnergyAmountNoVAT": 0,
"SvMissingEnergyViapAmountNoVAT": 0,
"MiMissingEnergyAmountNoVAT": 0,
"MiMissingEnergyViapAmountNoVAT": 0,
"VkMissingEnergyDiscountAmountNoVAT": 0,
"DdMissingEnergyDiscountAmountNoVAT": 0,
"NkMissingEnergyDiscountAmountNoVAT": 0,
"PowerPlantCapacityAmountNoVAT": 0,
"PermanentHomePlusAmountNoVAT": 0,
"PermanentHomeAmountNoVAT": 0
}
]

```

| Attribute | type | obligation | description |
|-----------|------|------------|--|
| - | - | - | Response description are provided in https://datahub.eso.lt/dokumentacija . In next document version, all fields description will be provided here. |

Below are the error codes and messages. Response codes and response content in case of error:

7.11.3.3 Response Error codes

| Code | Message | Explanation |
|------|--|--|
| 1. | Currently accounting data are not complete and it will be generated within 5 working days. You will be informed separately as soon as data will be complete and ready for a use. | - |
| 1004 | The value of the count parameter must be less or equal to 10 000. | The value of the count parameter cannot be above 10 000. |

7.11.4 POST /reports/accounting-data-pack-b2b-meters-level-count

| | | | |
|---------------------|---|---------------|--|
| URI | POST /reports/accounting-data-pack-b2b-meters-level-count | | |
| Description | Method which will return count (number), how many items Supplier will get in „POST /reports/accounting-data-pack-b2b-meters-level“ report (reports could have more than 1 item, so it is List). It should be used when supplier need to split data in few portions. This response should be used in „POST /reports/accounting-data-pack-b2b-meters-level“ method request, where Supplier can provide method parameters information. | | |
| Parameters | none | | |
| Request Body | Data order must be submitted in HTTP request body in a form of JSON | | |
| Response | HTTP status code | Reason | Response description |
| | 201 | Created | Request completed successfully |
| | 400 | Bad Request | Request error. The HTTP response body provides a list of errors in JSON format. |
| | 401 | Unauthorized | An attempt was made to connect to a non-public method that requires authentication, but no user credentials were provided. |
| | 403 | Forbidden | According to the access control policy, the current user does not have access to perform the requested action. |

| | | | |
|--------------|------------|---|--|
| | 404 | Not Found | Either there is no API method associated with the request URL path, or the request contains one or more parameters that did not return the data. |
| | 423 | Locked | The source or destination resource of a method is locked. This response SHOULD contain an appropriate precondition or postcondition code, such as 'lock-token-submitted' or 'no-conflicting-lock'. |
| Rules | No. | Rule description | Attributes |
| | 0. | If an attribute has defined possible values, the value index can be specified by specifying the value of the attribute in the request. Indices of all possible values start from 0. | All attributes with specified values. |
| | 1. | Counts report list items and return SUM of all report lines | - |
| | 2. | The operator does not provide interim data. The operator provides only final / complete data. | |

7.11.4.1 JSON Request structure

| JSON Request structure | | | |
|---|------------|--------------|---|
| <pre>{ "customerCode": "string", "dateFrom": "date", "dateTo": "date", "objectNo": "string" }</pre> | | | |
| Attribute | type | obligation | description |
| customerCode | String(32) | not required | User code of contracted customer |
| dateFrom | Date | required | Date from which data from DSO Billing system should be included into report |
| dateTo | Date | required | Date to which data from DSO Billing system should be included into report |

| | | | |
|----------|------------|--------------|---|
| objectNo | String(20) | not required | Object Number of the object for the supply of electricity in which the contract is concluded. |
|----------|------------|--------------|---|

7.11.4.2 JSON Response structure

| JSON Response structure | | | |
|----------------------------------|------------|------------|---|
| <pre>{ "count": "number" }</pre> | | | |
| Attribute | type | obligation | description |
| count | number(10) | required | Returns number, how many items are in report items list. This response can be used in accounting-data-pack-b2b-meters-level report parameters to split data in few response portions (if need pagination) |

Below are the error codes and messages. Response codes and response content in case of error:

7.11.4.3 Response Error codes

| Code | Message | Explanation |
|------|--|-------------|
| 1. | Currently accounting data are not complete and it will be generated within 5 working days. You will be informed separately as soon as data will be complete and ready for a use. | - |

7.12 Access rights controller – *will be deprecated in the future, preliminary date – 2023-05-23*

Using this API method, the vendor grants itself the right to access the historical data of the client objects on behalf of the customer. Once the rights have been granted, the supplier can download the customer's historical data for a certain period of time and, on that basis, offer the customer a contract.

7.12.1 POST /access-rights/client/data-access-rights

| | |
|--------------------|---|
| URI | POST /access-rights/client/data-access-rights |
| Description | The supplier can grant rights by his self to access clients historical data if has client agreement |
| Parameters | none |

| | | | |
|---------------------|---|--|--|
| Request Body | POST request structure provided in BODY | | |
| Response | HTTP status code | Reason | Response description |
| | 201 | Created | Request completed successfully |
| | 400 | Bad Request | Request error. The HTTP response body provides a list of errors in JSON format. |
| | 401 | Unauthorized | An attempt was made to connect to a non-public method that requires authentication, but no user credentials were provided. |
| | 403 | Forbidden | According to the access control policy, the current user does not have access to perform the requested action. |
| | 404 | Not Found | Either there is no API method associated with the request URL path, or the request contains one or more parameters that did not return the data. |
| Rules | No. | Rule description | Attributes |
| | 0. | If an attribute has defined possible values, the value index can be specified by specifying the value of the attribute in the request. Indices of all possible values start from 0. | All attributes with specified values. |
| | 1. | If the object belongs to a household consumer, the term of validity of the right may be a maximum of only 1 year | expires |
| | 2. | If the object belongs to a legal person, the term of validity of the right may be unlimited.  In this software version, expiration time for legal customers is 1 year. | expires |
| | 3. | "clientPermission" field is required and it has only one possible value which is provided in Your agreement/documentation." | clientPermission |

7.12.1.1 JSON Request structure

The table below describes the JSON structure and elements of the data access rights request:

| JSON Request structure | | | |
|--|--------------|--------------|---|
| <pre>[{ "objectNumber": "string", "customerId": "string", "expires": "date", "contactEmail": "contactEmail", "contactPhone": "contactPhone", "contactNotes": "contactNotes", "clientPermission": "string" }]</pre> | | | |
| Attribute | type | obligation | description |
| objectNumber | String(20) | required | Object number |
| customerId | string(32) | required | Customer ID which access right is granted |
| expires | date | required | The date that determines how long the rights are valid. It is possible to provide a date (in the case of private customer), or "null" (in the case of a legal entity). ⚠ In this software version, expiration time for legal customers is 1 year. |
| contactEmail | String(128) | not required | The contact email address of the user who owns the objects. |
| contactPhone | String(128) | not required | The phone number of the user who owns the items. |
| contactNotes | String(4000) | not required | Field allowing general type (adjustment) information to be entered. |
| clientPermission | String(4000) | required | Required value: "I confirm that the consent of the specified person / company to receive and process personal / company data has been obtained (person's name, surname / company name, person / company code, address, contact details, facility and electricity consumption data)." |

7.12.1.2 JSON Response structure

If the data access rights request is successful, method will not return any data model, but HTTP 201 Created status.

| JSON Response structure | | | |
|--|------|------------|-------------|
| If the request is successful, an HTTP 201 Created message is returned | | | |
| Attribute | type | obligation | description |
| - | - | - | - |

7.12.1.3 Response Error codes

Below are the error codes and messages. Response codes and response content in case of error:

| Code | Message | Explanation |
|------|--|---|
| 1 | "Object number and customer id combination was not found". | Object number and customer id combination not match any data in DataHub DataBase |
| 2 | "Incorrect access right expires date value" | Household customers can have only max 365 days value starting from sysdate when method is calling . |
| 6 | " clientPermission field is required and it has only one possible value which is provided in Your agreement/documentation." | The string content in the clientPermission query field does not match the required string content. |

Response example in case of error

```
{
  "errorMessages": [
    {
      "code": 0,
      "text": "string"
    }
  ]
}
```

7.12.2 GET /access-rights/client/granted-objects?first={integer}&count={integer}&sort={ASC/DSC}

| | | | |
|---------------------|--|---|--|
| URI | GET /access-rights/client/granted-objects?first={integer}&count={integer}&sort={ASC/DSC} | | |
| Description | The supplier can get a list of all customers who have granted the rights to the objects. | | |
| Parameters | <p>URL parameters:</p> <p>first - index (starting from 0) of the object that must be presented first in the return list. Optional. The default value is 0.</p> <p>count - number of objects in the return list. Optional. The default value is 30.</p> <p>sort - sorting by date of grant. Possible values ASC, DSC. The default is ASC.</p> | | |
| Request Body | none | | |
| Response | HTTP status code | Reason | Response description |
| | 204 | No Content | Request completed successfully |
| | 400 | Bad Request | Request error. The HTTP response body provides a list of errors in JSON format. |
| | 401 | Unauthorized | An attempt was made to connect to a non-public method that requires authentication, but no user credentials were provided. |
| | 403 | Forbidden | According to the access control policy, the current user does not have access to perform the requested action. |
| | 404 | Not Found | Either there is no API method associated with the request URL path, or the request contains one or more parameters that did not return the data. |
| Rules | No. | Rule description | Attributes |
| | 1. | The vendor authentication key identifies the vendor ID and selects only the rights assigned to that vendor. | Authentication key |

| | | | |
|--|----|---|---|
| | 2. | By default, if first, count, sort values are not specified, then the first 30 values of the list of objects and contacts not expired rights are returned according to the most recently granted date. | URL parameters- first, count, sort |
|--|----|---|---|

7.12.2.1 JSON Request structure

The table below describes URL request attributes:

| JSON Request structure | | | |
|--|-----------|--------------|--|
| This method has no request data structure. | | | |
| Attribute | type | obligation | description |
| first | integer | not required | Index (starting from 0) of the object that must be presented first in the return list. |
| count | integer | not required | Number of objects in the return list. |
| sort | string(3) | not required | Sorting by date of grant. Possible values ASC, DSC. The default is ASC. |

7.12.2.2 JSON Response structure

The table below describes the JSON structure and elements of client object information response:

| JSON Response structure |
|---|
| <pre>[{ "customerId": "string", "objectNumber": "string", "objectAddress": "string", "automationLevel": "string", "clientName": "string", "expires": "date", "contactPhone": "contactPhone", "contactEmail": "contactEmail", "contactNotes": "contactNotes", "downloadDate": "date", "source": "string", "issueDate": "datetime" }]</pre> |

| Attribute | type | obligation | description |
|------------------------|--------------|--------------|--|
| customerId | string(32) | required | User code of the customer |
| objectNumber | string(20) | required | Object Number |
| objectAddress | string(4000) | required | Address of the object |
| automationLevel | string(7) | not required | Object accounting automation level. |
| clientName | string(200) | required | Client name: Name Surname - if household customer Company name - if a legal entity |
| expires | date | required | The date by which the rights are valid. |
| contactEmail | string(128) | not required | The contact email address of the user who owns the objects. |
| contactPhone | string(128) | not required | The phone number of the user who owns the items. |
| contactNotes | string(4000) | not required | Field allowing general type (adjustment) information to be entered. |
| downloadDate | datetime | not required | The date and time that tells you when the historical consumption data was last downloaded. |
| source | string(5) | required | A field describing who granted the rights. Possible values: "ESO-S" - provided by the customer "NT" - provided by the supplier |
| issueDate | datetime | required | Date indicating when the right was granted. |

7.12.3 POST /access-rights/client/data-access-rights/delete

| | |
|--------------------|--|
| URI | POST /access-rights/client/data-access-rights/delete |
| Description | The supplier may remove the rights granted to him. He granted the rights himself with the client's permission, or the rights were granted to him by the client through ESO-S. The supplier can remove remove on rights which was granted by himself. |
| Parameters | none |

| | | | |
|---------------------|--|--|--|
| Request Body | POST request structure provided in BODY | | |
| Response | HTTP status code | Reason | Response description |
| | 204 | No Content | Request completed successfully |
| | 400 | Bad Request | Request error. The HTTP response body provides a list of errors in JSON format. |
| | 401 | Unauthorized | An attempt was made to connect to a non-public method that requires authentication, but no user credentials were provided. |
| | 403 | Forbidden | According to the access control policy, the current user does not have access to perform the requested action. |
| | 404 | Not Found | Either there is no API method associated with the request URL path, or the request contains one or more parameters that did not return the data. |
| Rules | No. | Rule description | Attributes |
| | 0. | If an attribute has defined possible values, the value index can be specified by specifying the value of the attribute in the request. Indices of all possible values start from 0. | All attributes with specified values. |
| | 1. | The supplier authentication key determines the supplier ID and selects only the rights assigned to that supplier, selects only those objects for which the rights were granted by the supplier. | Authentication key, source |
| | 2. | The values of customerId and objectNumber are specified. Only the objects for which the rights have been granted by the supplier are selected according to the source field with the value "NT". It is checked whether the specified codes belong to the connected supplier and whether the objects belong to the customer codes and if there is a dependency, the rights are removed from the list. | customerId , objectNumber, supplierId, source |
| 3. | At least one of the list items (customers or objects) is required to provide to delete rights from DataHub Database rights list. | customers, objects | |

7.12.3.1 JSON Request structure

JSON Request structure

```
{
  "customerId":"string",
  "objectNumber":"string"
}
```

| Attribute | type | obligation | description |
|--------------|------------|--------------|---------------|
| customerId | string(32) | not required | customer code |
| objectNumber | String(20) | not required | Object Number |

7.12.3.2 Response Error codes

Below are the error codes and messages. Response codes and response content in case of error:

| Code | Message | Explanation |
|------|---|--|
| 1 | "customerId and objectNumber" do not match. Please check request data. | Could not select matches by specified ID and object codes. |
| 2 | "You can not revoke client provided permissions. We can not complete Your request, because access right for customerId or objectNumber was provided from client side." | The supplier specified objects or codes provided by the client that correspond to the ESO-S value in the source field. The supplier cannot remove the customer's consents. |

Response example in case of error

```
{
  "errorMessages": [
    {
      "code": 0,
      "text": "string"
    }
  ]
}
```

7.13 Data order controller – *will be deprecated in the future, preliminary date – 2023-05-23*

7.13.1 POST /v2/data/data-orders

| | | | |
|---------------------|---|---------------|--|
| URI | POST /v2/data/data-orders | | |
| Description | The supplier can request the customer's historical object consumption data, which can consist of 4 files (objektai<...>.csv, suminiai<...>.csv, valandiniai<...>.csv ir sutikimai<...>.csv) | | |
| Parameters | none | | |
| Request Body | Data order must be submitted in HTTP request body in a form of JSON | | |
| Response | HTTP status code | Reason | Response description |
| | 201 | Created | Request completed successfully |
| | 400 | Bad Request | Request error. The HTTP response body provides a list of errors in JSON format. |
| | 401 | Unauthorized | An attempt was made to connect to a non-public method that requires authentication, but no user credentials were provided. |
| | 403 | Forbidden | According to the access control policy, the current user does not have access to perform the requested action. |
| | 404 | Not Found | Either there is no API method associated with the request URL path, or the request contains one or more parameters that did not return the data. |

| Rules | No. | Rule description | Attributes |
|-------|-----|---|---------------------------------------|
| | 0. | If an attribute has defined possible values, the value index can be specified by specifying the value of the attribute in the request. Indices of all possible values start from 0. | All attributes with specified values. |
| | 1. | Supplier can get historical client information, only if has client permission and the object of the client has a valid contract in the DSO Billing system. | - |
| | 2. | Historical client information cannot be older than 36 months old. | periodStart |
| | 3. | The supplier may not adduce the same object code more than once when ordering historical data. | object code |
| | 4. | A supplier can include all objects into the data orders but only those objects which were not included in the previous data orders and no more than 100 objects per data order. If all suppliers' objects were included in the previous data orders the error message 11 will be displayed. | includeAllObjects |

7.13.1.1 JSON Request structure

| JSON Request structure | | | |
|--|---------|------------|--|
| <pre>{ "includeAllObjects": true, "includeHourlyReadings": true, "includeSummaryReadings": true, "objects": [{ "code": "string", "consumerCode": "string" }], "periodEnd": "2020-02-05", "periodStart": "2020-02-05" }</pre> | | | |
| Attribute | type | obligation | description |
| includeAllObjects | boolean | required | All objects data processing indicator: |

| | | | |
|-------------------------------|------------|----------|--|
| | | | <p>value true means that all objects which were not included in previous data orders and that were granted to the supplier at the moment of submission of order should be involved in data order processing;</p> <p>value false means that only objects that are explicitly listed in data order (see element Objects, below) should be involved in data order processing.</p> |
| includeHourlyReadings | boolean | required | Hourly readings indicator: value true means that hourly readings should be included in resulting data set; value false means that hourly readings should be omitted. Default value is false . |
| includeSummaryReadings | boolean | required | Summary (monthly) readings indicator: value true means that summary (monthly) readings should be included in resulting data set; value false means that summary (monthly) readings should be omitted. Default value is true . |
| objects[] | List | required | <p>A list of objects that should be involved in data order processing.</p> <p>Note: supplier should have a valid permission to retrieve specified object data at the moment of data order submission. Otherwise DataHub Gateway will reject data order and issue an appropriate error message.</p> <p>Required only in case allObjectsInd attribute (see above) value is false. The element must contain one or more Object elements</p> |
| objects[].code | string(20) | required | ESO issued object code. |
| objects[].consumerCode | string(32) | required | ESO issued consumer code of the client owning an object. |
| periodEnd | date | required | <p>The end date of the period for which electricity consumption data needs to be collected in a format YYYY-MM-DD, where YYYY – year, MM – month, DD – day (i.e. 2020-12-01, 2021-01-01).</p> <p>Note: during data order processing, the period end date specified is always adjusted to the last day of month.</p> |
| periodStart | date | required | <p>The start date of the period for which electricity consumption data needs to be collected in a format YYYY-MM-DD, where YYYY – year, MM – month, DD – day (i.e. 2019-12-01, 2020-01-01).</p> <p>Note: during data order processing, the period start date is always truncated to the first day of month.</p> |

7.13.1.2 JSON Response structure

JSON Response structure

```
{
  "completed": "2022-02-22T07:09:46.910Z",
  "id": 0,
  "inclHourlyReadings": true,
  "inclSummaryReadings": true,
  "periodEnd": "2022-02-22T07:09:46.910Z",
  "periodStart": "2022-02-22T07:09:46.910Z",
  "submitted": "2022-02-22T07:09:46.910Z"
}
```

| Attribute | type | obligation | description |
|------------------------|-----------|------------|---|
| completed | timestamp | required | Date and time when the data order was completed |
| id | number | required | Data order identification number |
| inclHourlyReadings | boolean | required | Hourly readings indicator: value true means that hourly readings is included in resulting data set; value false means that hourly readings is omitted. Default value is false . |
| includeSummaryReadings | boolean | required | Summary (monthly) readings indicator: value true means that summary (monthly) readings is included in resulting data set; value false means that summary (monthly) readings is omitted. Default value is true. |
| periodEnd | date | required | The end date of the period for which electricity consumption data will be collected in a format YYYY-MM-DD, where YYYY – year, MM – month, DD – day (i.e. 2020-12-01, 2021-01-01). Note: during data order processing, the period end date specified is always adjusted to the last day of month. |
| periodStart | date | required | The start date of the period for which electricity consumption data will be collected in a format YYYY-MM-DD, where YYYY – year, MM – month, DD – day (i.e. 2019-12-01, 2020-01-01). Note: during data order processing, the period start date is always truncated to the first day of month. |
| submitted | timestamp | required | The date and time when the data order was submitted |

7.13.1.3 Response Error codes

Below are the error codes and messages. Response codes and response content in case of error:

| Code | Message | Explanation |
|------|--|--|
| 1 | Required parameter includeAllObjects not specified. | Required parameter includeAllObjects must be included in request. |

| Code | Message | Explanation |
|------|---|--|
| 2 | Required parameter includeHourlyReadings not specified. | Required parameter includeHourlyReadings must be included in request. |
| 3 | Required parameter includeSummaryReadings not specified. | Required parameter includeSummaryReadings must be included in request. |
| 4 | Required parameters object code and consumer code not specified. | When includeAllObjects is false, then object code and user code must be specified |
| 5 | Object not found by object code and customer code or object does not have a valid DSO contract and access rights. | Object was not found in the DataHub or you do not have rights to this object, or the object does not have a valid contract in the Billing system. Please check provided information. |
| 6 | PeriodStart date must be less than periodEnd date. | Period date range is incorrectly specified. |
| 7 | PeriodStart date must be less than today. | PeriodStart date is incorrectly specified. |
| 8 | The maximum number of objects in one request is 100. | Request can contain a maximum of 100 objects. |
| 9 | PeriodStart date cannot be older than 36 months old. | PeriodStart date is too old. |
| 10 | The object code cannot be repeated in the same historical data order. | The object code cannot be repeated multiple times in the same historical data order. |
| 11 | All objects were included in the previous data orders. | If includeAllObjects is True and the all supplier objects were included in the previous data orders. There are no objects to include. |

7.13.2 GET /data/data-orders/{orderId}/data

| | |
|---------------------|--|
| URI | GET /data/data-orders/{orderId}/data |
| Description | When calling POST /v2/data/data-orders method, supplier get response with <i>orderId</i> which is used calling GET /data/data-orders/{orderId}/data method to download historical clients consumption data, objects information and consents in ZIP file format. |
| Parameters | orderId - unique data order identifier which is provided calling POST /v2/data/data-orders method. |
| Request Body | none |

| Response | HTTP status code | Reason | Response description |
|----------|------------------|--|--|
| | 200 | Created | request successfully processed. HTTP response body contains ZIP format file containing collected data (see Contents of ZIP archive, below). |
| | 204 | No Content | No data found according to the given parameters. |
| | 400 | Bad Request | Request error. The HTTP response body provides a list of errors in JSON format. |
| | 401 | Unauthorized | An attempt was made to connect to a non-public method that requires authentication, but no user credentials were provided. |
| | 403 | Forbidden | According to the access control policy, the current user does not have access to perform the requested action. |
| | 404 | Not Found | Either there is no API method associated with the request URL path, or the request contains one or more parameters that did not return the data. |
| Rules | No. | Rule description | Attributes |
| | 1. | before calling this method, Supplier has to be already called POST /v2/data/data-orders method, which returns orderId. | orderId |

7.13.2.1 JSON Request structure

| JSON Request structure | | | |
|------------------------|------|------------|-------------|
| BODY - none | | | |
| URL - orderId | | | |
| Attribute | type | obligation | description |

| orderId (URL) | number(10) | required | URL attribute which is required. (info)This attribute value supplier gets calling POST /v2/data/data-orders method. |
|---|------------|------------|--|
| 7.13.2.2 JSON Response structure | | | |
| HTTP response body contains ZIP format file containing collected data (see <i>Contents of ZIP archive</i> , below). | | | |
| Attribute | type | obligation | description |
| - | - | - | - |

7.13.2.3 Contents of ZIP archive

- **Objektai <order id> [<period start> - <period end>] <timestamp>.csv** – general information on objects listed in data order and referenced in files **Suminiai <...>.csv** ir **Valandiniai <...>.csv** (see below), in CSV format.
- **Suminiai <order id> [<period start> - <period end>] <timestamp>.csv** – summary (monthly) electricity consumption data, in CSV format. File is provided only in case summary (monthly) electricity consumption data is requested when submitting data order (see description of **inclSummaryReadings** data order attribute).
- **Valandiniai <order number> [<period start> - <period end>] <timestamp>.csv** – hourly electricity consumption data, in CSV format. File is provided only in case hourly electricity consumption data is requested when submitting data order (see description of **inclHourlyReadings** data order attribute).
- **Sutikimai <order number> [<period start> - <period end>] <timestamp>.csv** - file containing clients' consents giving supplier a limited right to process clients' data and conduct direct marketing – submit to clients commercial proposals on electricity supply. Consents are provided only in case the client is household person on one line per client basis.

The flowing is a list of markups used in above mentioned file names:

- **<order id>** – unique data order identifier (i.e., 1234569, 984785, etc.)
- **<period start>** – the start date of the period for which the electricity consumption data must be collected, truncated to months (i.e. 2018-09, 2018-10, etc.)
- **<period end>** – the end date of the period for which the electricity consumption data must be collected, truncated to months (i.e. 2019-11, 2019-12, etc.)
- **<timestamp>** – date and data time data order processing started (i.e., 2019-10-30 22:55:45, 2020-01-01 23:15:01, etc.)

The first field (**Objekto Numeris**) in each CSV file contains unique ESO issued object number which should be used to establish relationships between data rows in CSV files (see figure below):

All CSV files included in ZIP archive adheres the following rules:

1. The very first line of the file provides data record field headers. Data records follow header line.
2. In order to ensure compatibility with Microsoft Excel, both field headers and field values are separated by semicolons (ASCII decimal code 59).

3. Comma symbol (ASCII decimal code 44) is used as decimal point separator in number values.
4. The contents of CSV files are provided in UTF-8. The first three bytes of the file are reserved for Byte Order Mark.

7.13.2.3.1 File Objektai <...>.csv

The following table describes the structure of Objektai <...>.csv file:

| No | Field Name | ANSI SQL Data Type | Description |
|----|--|--------------------|--|
| 1 | Objekto numeris / Object Number | VARCHAR(20) | ESO issued unique object number. |
| 2 | Kliento įmonės kodas / Client Company Code | VARCHAR(20) | The registry code of client company owning the object. |
| 3 | Kliento pavadinimas . Client Name | VARCHAR(200) | The name of client company or, in case client is natural person, – client’s first and last names (space separated). |
| 4 | Objekto pavadinimas / Object Name | VARCHAR(200) | Object name. |
| 5 | Objekto tipas / Object Type | VARCHAR(200) | Object type. |
| 6 | Objekto adresas / Object Address | VARCHAR(4000) | Object address. |
| 7 | Leistinoji galia (kW) / Permitted Power (kW) | DECIMAL(10,3) | Permitted electrical power on object site, kW. |
| 8 | Viso skaitiklių / Total Number of Meters | DECIMAL(3) | Total number of electricity meters installed on object site. |
| 9 | Automatizuotų skaitiklių / Total Number of Smart Meters | DECIMAL(3) | Total number of smart electricity meters installed on object site. |
| 10 | Automatizacijos lygmuo / Automation Level | VARCHAR(7) | Electricity consumption accounting automation level on object site. Allowable field values are as follows: Nėra (none) – object site has no smart meters installed. Dalinis (partial) – part of meters installed on object site are smart meters. Pilnas (full) – all meters installed on object site are smart meters. |
| 11 | Tarifo planas / Tariff plan | VARCHAR(255) | Tariff plan which is used at this moment by client |
| 12 | Galima tarifo plano keitimo data / Possible date of tariff plan change | TIMESTAMP | Date which describes when client can change his tariff plan at ESO |

| No | Field Name | ANSI SQL Data Type | Description |
|----|--|--------------------|--|
| 13 | Įtampa / Voltage | FLOAT8 | Voltage in client's object |
| 14 | Telefonas / Phone | VARCHAR(128) | Client contact phone number for communicating the details of commercial proposal. |
| 15 | El. pašto adresas / Email Address | VARCHAR(128) | Client contact email address for communicating the details of commercial proposal. |
| 16 | Pastabos / Notes | VARCHAR(4000) | Additional client information the supplier should consider while preparing the commercial proposal. |
| 17 | Teisė galioja iki / Access Rights Valid To | DATE | Date the permission to access object site's consumption data expires. Field value format: YYYY-MM-DD, where: YYYY– year, MM – month, DD – day (i.e., 2019-10-30, 2020-01-01, etc.). |
| 18 | Paskutinį kartą duomenys gauti / Last Time Data Downloaded | TIMESTAMP | Last date and time the supplier downloaded object site's consumption data. Field value format: YYYY-MM-DD HH:MI:SS, where: YYYY– year, MM – month, DD – day, HH – hour (in 24 hours system), MI – minutes, SS – seconds (i.e. 2019-10-30 23:59:01, 2020-01-01 11:05:59, etc.). |

7.13.2.3.2 File Suminiai <...>.csv

The following table describes the structure of **Suminiai <...>.csv** file:

| No | Field Name | ANSI SQL Data Type | Description |
|----|--|--------------------|--|
| 1 | Objekto numeris / Object Number | VARCHAR(20) | ESO issued unique object number. |
| 2 | Priskaitymo periodas / Accounting Period | DATE | Accounting month the amount of consumed electricity is allocated to. Field value format: YYYY-MM , where: YYYY – year, MM – month. |
| 3 | VK | DECIMAL(12,2) | Amount of consumed single-priced electricity, kWh. |
| 4 | DD | DECIMAL(12,2) | Amount of consumed day-time electricity, kWh. |
| 5 | NK | DECIMAL(12,2) | Amount of consumed night-time and weekend electricity, kWh. |
| 6 | MA | DECIMAL(12,2) | Amount of consumed peak-load electricity, kWh. |
| 7 | VD | DECIMAL(12,2) | Amount of consumed average-load electricity, kWh. |
| 8 | SV | DECIMAL(12,2) | Amount of electricity consumed during holidays and day offs, kWh. |
| 9 | MI | DECIMAL(12,2) | Amount of consumed minimum-load electricity, kWh. |
| 12 | D1 | DECIMAL(12,2) | Amount of consumed day electricity, kWh. |
| 13 | N1 | DECIMAL(12,2) | Amount of consumed night electricity, kWh. |
| 14 | D2 | DECIMAL(12,2) | Amount of consumed evening electricity, kWh. |
| 15 | N2 | DECIMAL(12,2) | Amount of consumed morning electricity, kWh. |
| 10 | RV | DECIMAL(12,2) | Amount of consumed reactive electricity, kWh. |
| 11 | RG | DECIMAL(12,2) | Amount of generated reactive electricity, kWh. |
| 16 | Aktyvioji vartojama energija kiekis, kWh/ Amount of active energy consumed, kWh | DECIMAL(12,2) | Total amount of consumed electricity, kWh. |

7.13.2.3.3 File Valandiniai <...>.csv

The following table describes the structure of **Valandiniai <...>.csv** file:

| No | Field Name | ANSI SQL Data Type | Description |
|----|---------------------------------|--------------------|---|
| 1 | Objekto numeris / Object Number | VARCHAR(20) | ESO issued unique object number. |
| 2 | Data, valanda / Date, Hour | VARCHAR(13) | Date and hour the readings were taken. Field value format: YYYY-MM-DD HH , where: YYYY – year, MM – month, DD – day, HH – hour (in 24-hour system) (i.e. 2019-10-30 13, 2020-01-01 23, etc.). |
| 3 | Energijos tipas / Energy Type | VARCHAR(2) | Type of electricity consumed / generated. Allowable field values are as follows: P+ – active P+ energy P- – active P- energy Q+ – reactive Q+ energy Q- – reactive Q- energy Note: this software version provides active P+ and P- energy consumption data. |
| 4 | Kiekis, kWh / Amount, kWh | DECIMAL(13,3) | Amount of electricity consumed, or generated kWh. |

7.13.2.3.4 File Sutikimai <...>.csv

The following table describes the structure of **Valandiniai <...>.csv** file:

| No | Field Name | ANSI SQL Data Type | Description |
|----|-------------------------------------|--------------------|---|
| 1 | KLIENTO_PAVADINIMAS/ CLIENT_NAME | VARCHAR(200) | Client name and surname (if household client), company name (if legal client) who gives consent |
| 2 | DATA/ DATE | VARCHAR(10) | Date when consent was given Field value format: YYYY-MM-DD , where: |

| No | Field Name | ANSI SQL Data Type | Description |
|----|---------------------|--------------------|---|
| | | | YYYY – year, MM – month, DD – day, (i.e. 2019-10-30, 2020-01-01, etc.). |
| 3 | SUTIKIMAS / CONSENT | VARCHAR(5000) | Consent content Note: earlier consent was in PDF format (one PDF per client), now all consent data will be provided in Sutikimai<...>.csv file (one line per client). |

Below are the error codes and messages. Response codes and response content in case of error:

7.13.2.4 Response Error codes

| Code | Message | Explanation |
|------|--------------------------------|---|
| 1 | OrderId must be number. | Incorrect parameter data types. |
| 2 | Order could not be found. | Order was not found in the DataHub or the order belongs to another supplier. Please check provided information. |
| 3 | Request is being processed. | Data is still being prepared. |

Response example in case of error

```
{
  "errorMessages": [
    {
      "code": 0,
      "text": "string"
    }
  ],
  "orderId": null
}
```