

## Content

1. Documentation version history .....	4
2. Preface .....	67
3. Definitions and abbreviations .....	68
4. Environments .....	68
5. Suppliers' digital certificates .....	69
6. Recommendation for API client.....	69
6.1 SYNC.....	69
7. DataHub Gateway API documentation .....	72
7.1 Declaration controller.....	72
7.1.1 GET /gateway/supplier/v3/get-declaration-data?first={integer}&count={integer}&customerId={string}&objectNumber={string}.....	72
7.1.2 POST /gateway/declaration/reading/list .....	78
7.1.3 POST /gateway/supplier/send-declaration-data.....	86
7.2 Supplier change notification controller .....	93
7.2.1 POST /supplier/v2/supplier-change-notifications (new) .....	93
7.2.2 POST /supplier/cancel-supplier-change-notification .....	99
7.2.3 POST /supplier/client/client-objects-information (new) .....	101
7.3 Access right controller – new (will be deployed in the future, preliminary date – 12.01) .....	106
7.3.1 POST/gateway/access-right/list .....	106
7.3.2 POST /gateway/access-right.....	114
7.3.3 POST /gateway/access-right/{accessRightUuid}/cancel.....	121
7.4 Data order controller.....	123
7.4.1 POST /v2/data/data-orders .....	123
7.4.2 GET /data/data-orders/{orderId}/data.....	128
7.5 Report controller.....	135
Old methods of the reports.....	135
7.5.1 POST /reports/accounting-data-pack-b2c?first={integer}&count={integer}.....	136
7.5.2 POST /reports/accounting-data-pack-b2c-count.....	152

7.5.3	POST /reports/accounting-data-pack-b2b-meters-level?first={integer}&count={integer}	155
7.5.4	POST /reports/accounting-data-pack-b2b-meters-level-count	169
7.5.5	POST /reports/objects-data-pack?first={integer}&count={integer}	171
7.5.6	POST /reports/objects-data-pack-count	175
7.6	Object controller	178
7.6.1	POST /gateway/object/my/active/list?first={integer}&count={integer}&sortKey={string}&sortOrder={ASC/DSC}	178
7.6.2	POST /gateway/object/all/active/list?first={integer}&count={integer}&sortKey={string}&sortOrder={ASC/DSC}	190
7.7	Contract controller	198
7.7.1	POST/gateway/contract/list?first={integer}&count={integer}&sortKey={string}&sortOrder={ASC/DSC}	198
7.8	Notification contract controller - new	205
7.8.1	POST /gateway/notification/contract/list?first={integer}&count={integer}&sortOrder={ASC/DSC}	205
7.8.2	POST /gateway/notification/contract	217
7.8.3	POST /gateway/notification/{notificationId}/contract/cancel	242
7.9	Notification contract termination controller	244
7.9.1	POST /gateway/notification/contract/termination/list?first={integer}&count={integer}&sortOrder={ASC/DSC}	244
7.9.2	POST /gateway/notification/contract/termination	252
7.9.3	POST /gateway/notification/{notificationId}/contract/termination/cancel	262
7.10	Notification contract tariff plan controller (will be deployed in the future)	264
7.10.1	POST /gateway/notification/contract/tarif-plan/list?first={integer}&count={integer}&sortKey={string}&sortOrder={ASC/DSC}	264
7.10.2	POST /gateway/notification/contract/tariff-plan	271
7.10.3	POST /gateway/notification/{notificationId}/contract/tariff-plan/cancel	279
7.11	Notification contract contact controller (will be deployed in the future)	282
7.11.1	POST /gateway/notification/contract/contact/list?first={integer}&count={integer}&sortKey={string}&sortOrder={ASC/DSC}	282
7.11.2	POST /gateway/notification/contract/contact	290
7.11.3	POST /gateway/notification/{notificationId}/contract/contact/cancel	298
7.12	Order controller	300
7.12.1	POST/gateway/order/list?first={integer}&count={integer}&sortKey={string}&sortOrder={ASC/DSC}	300

7.12.2	POST/gateway/order/{hr15OrderShortName}.....	305
7.12.3	POST/gateway/order/{orderShortName}.....	309
7.12.4	GET/gateway/order/{orderId}/data-hr-15min-obj-lvl.....	313
7.12.5	GET/gateway/order/{orderId}/data-hr-15min-mtr-lvl.....	316
7.12.6	GET/gateway/order/{orderId}/bill-2s2s-b2b.....	320
7.12.7	GET/gateway/order/{orderId}/report-obj.....	325
7.12.8	GET/gateway/order/{orderId}/bill-bss-b2c.....	328
7.12.9	GET/gateway/order/{orderId}/bill-bss-b2b.....	343
7.12.10	GET/gateway/order/{orderId}/count.....	356
7.12.11	POST/gateway/order/data-hr-15min-mtr-lvl-acr.....	359
	POST/gateway/order/data-hr-15min-mtr-lvl-acr.....	359
7.12.12	POST/gateway/order/data-hr-15min-obj-lvl-acr.....	362
	POST/gateway/order/data-hr-15min-obj-lvl-acr.....	363
7.12.13	POST/gateway/order/data-sum-obj-lvl-acr.....	366
	POST/gateway/order/data-sum-obj-lvl-acr.....	366
7.12.14	POST/gateway/order/report-obj-acr.....	369
	POST /gateway/order/report-obj-acr.....	369
7.12.15	GET /gateway/order/{orderId}/data-hr-15min-obj-lvl-acr?first={integer}&count={integer}.....	371
	GET /gateway/order/{orderId}/data-hr-15min-obj-lvl-acr?first={integer}&count={integer}.....	371
7.12.16	GET /gateway/order/{orderId}/data-hr-15min-mtr-lvl-acr?first={integer}&count={integer}.....	375
	GET /gateway/order/{orderId}/data-hr-15min-mtr-lvl-acr?first={integer}&count={integer}.....	375
7.12.17	GET /gateway/order/{orderId}/report-obj-acr?first={integer}&count={integer}.....	379
	GET /gateway/order/{orderId}/report-obj-acr?first={integer}&count={integer}.....	379
7.12.18	GET /gateway/order/{orderId}/data-sum-obj-lvl-acr?first={integer}&count={integer}.....	383
	GET /gateway/order/{orderId}/data-sum-obj-lvl-acr?first={integer}&count={integer}.....	383
7.13.....	Notification cancellation – new	
	387	
7.13.1	POST /gateway/notification/cancellation/list?first={integer}&count={integer}&sortOrder={ASC/DSC}.....	387
	POST /gateway/notification/cancellation/list?first={integer}&count={integer}&sortOrder={ASC/DSC}.....	387

7.13.2	POST /gateway/notification/cancellation .....	393
	POST /gateway/notification/cancellation .....	393
7.13.3	POST /gateway/notification/{notificationId}/cancellation/cancel .....	399
	POST /gateway/notification/{notificationId}/cancellation/cancel .....	399
7.14	.....Notification contract object supply state controller (will be deployed in the future, preliminary date – 10.11)	
401		
7.14.1	POST /gateway/notification/contract/object/supply-state/list?first={integer}&count={integer}&sortOrder={ASC/DSC} .....	401
7.14.2	POST /gateway/notification/contract/object/supply-state .....	409
7.14.3	POST /gateway/notification/{notificationId}/contract/object/supply-state/cancel .....	415
7.15	..... Access rights controller - old	
418		
7.15.1	POST /access-rights/client/data-access-rights .....	418
7.15.2	GET /access-rights/client/granted-objects?first={integer}&count={integer}&sort={ASC/DSC} .....	421
7.15.3	POST /access-rights/client/data-access-rights/delete .....	424

## 1. Documentation version history

The table below provides information on document version history:

Version	Date	Description
0.1	2019-11-15	Initial document version.
0.2	2019-11-18	Updated bdHorder Gateway component internet addresses by adding ports.
0.3	2019-11-18	DataHub Sandbox and Production manual.
0.4	2020-01-04	API changes from XML to JSON.
0.5	2020-09-07	Existing documentation changed by adding information about request/response parameters, added fields types and description, explanations, etc.
0.6	2020-09-21	New methods added, existing methods changed by adding personal and company code parameters, customerCode and objectCode fields renamed, other changes.
0.6.1	2020-09-22	<ul style="list-style-type: none"> <li>• Existing Supplier change notification method will remain and new method (/supplier/v2/supplier-change-notifications) deployed as version v2; <ul style="list-style-type: none"> <li>○ response JSON model added to both Supplier change notification methods (v1 and v2);</li> <li>○ new rules explanation added;</li> <li>○ Some error messages changed;</li> </ul> </li> </ul>

		<ul style="list-style-type: none"> <li>• /client/client-objects-information method: <ul style="list-style-type: none"> <li>○ success response code changed from to 201 to 200;</li> <li>○ changes in method rules table;</li> <li>○ changes in method error messages table;</li> </ul> </li> <li>• /client/client-objects-information (new) method : <ul style="list-style-type: none"> <li>○ method was moved to supplier-change-notification controller;</li> <li>○ response model contractType field will return <i>null</i> till next DataHub API version update;</li> </ul> </li> <li>• POST /client/data-access-rights (new) <ul style="list-style-type: none"> <li>○ Request structure was changed (object list was removed)</li> <li>○ Some error messages changed;</li> </ul> </li> <li>• GET /client/granted-objects (new) <ul style="list-style-type: none"> <li>○ Header count parameter value can be only numbers;</li> <li>○ Response structure was changed (objects list was removed)</li> <li>○ Some error messages changed;</li> </ul> </li> <li>• POST /client/data-access-rights/delete (new) <ul style="list-style-type: none"> <li>○ Request structure was changed (object list and customers list were removed)</li> <li>○ Some error messages changed;</li> </ul> </li> <li>• Reports controller: <ul style="list-style-type: none"> <li>○ POST /reports/accounting-data-pack-b2c and POST /reports/objects-data-pack response models changed;</li> </ul> </li> <li>• GET /data/data-orders/{orderId}/data method response changes: <ul style="list-style-type: none"> <li>○ File Valandiniai &lt;...&gt;.csv - P- field added;</li> <li>○ File Suminiai &lt;...&gt;.csv - D1, D2, N1, N2 fields added;</li> <li>○ File Objektai &lt;...&gt;.csv - automation Level field will return new values;</li> </ul> </li> </ul>
0.6.2	2020-10-07	<p>Added information about Declaration process:</p> <ul style="list-style-type: none"> <li>• Supplier-change-notification v2 <ul style="list-style-type: none"> <li>○ One Error code was removed (error code 4 in previous documentation).</li> </ul> </li> <li>• Declaration controller section was created <ul style="list-style-type: none"> <li>○ Technical description was added: <ul style="list-style-type: none"> <li>▪ GET /supplier/get-declaration-data - method to get all required data about client to implement declaration process;</li> <li>▪ POST /supplier/send-declaration-data - method to send clients' declaration data to DSO;</li> </ul> </li> </ul> </li> </ul>
0.6.3	2020-10-16	<p>Added additional information in Declaration GET /supplier/get-declaration-data method data model:</p> <ul style="list-style-type: none"> <li>○ clientId and scaleType information;</li> </ul>
0.6.4	2020-11-06	<ul style="list-style-type: none"> <li>• Added response error codes in POST /data/data-orders and GET /data/data-orders/{orderId}/data methods.</li> </ul>

		<ul style="list-style-type: none"> <li>• GET /supplier/get-declaration-data <ul style="list-style-type: none"> <li>○ readings[].conversionPoss - changed data type from string to boolean</li> <li>○ readings[].scales[].readingFromDate - date format specified to YYYY-MM-DDThh:mm:ss</li> </ul> </li> <li>• POST /supplier/send-declaration-data <ul style="list-style-type: none"> <li>○ conversion - changed data type from string to boolean</li> <li>○ dataWriteDate - date format specified to YYYY-MM-DDThh:mm:ss</li> </ul> </li> </ul>
0.6.5	2020-11-23	<p>Method supplier-change-notifications: added new error (202 Object number "{objectNumber}" repeats.)</p> <p>Changed URL parameters in methods: added first and count.</p> <ul style="list-style-type: none"> <li>• GET supplier/get-declaration-data</li> <li>• GET client/granted-objects</li> <li>• GET reports/accounting-data-pack-b2b</li> <li>• GET reports/accounting-data-pack-b2b-meters-level</li> <li>• GET reports/accounting-data-pack-b2c</li> <li>• GET reports/objects-data-pack</li> </ul>
0.6.6	2020-12-08	New method version POST /reports/accounting-data-pack-b2c added new fields for "Additional component of distribution service" (Sppd).
0.6.7	2020-12-08	<p>In methods POST /reports/accounting-data-pack-b2c, POST /reports/accounting-data-pack-b2b and POST /reports/accounting-data-pack-b2b-meters-level added new fields:</p> <ul style="list-style-type: none"> <li>• AccumulatedUploadedConsumptionAmount;</li> <li>• AccumulatedRaisedConsumptionAmount.</li> </ul> <p>Old field AccumulatedTransferredConsumptionAmount will be deleted after the transition period (about 1 month).</p>
0.6.8	2021-01-29	<p>Updated JSON specification of POST /reports/accounting-data-pack-b2b-meters-level method. Added new fields:</p> <ul style="list-style-type: none"> <li>• AccumulatedBeginningConsumptionAmount</li> <li>• AccumulatedEndConsumptionAmount</li> <li>• ConsumedElectricityConsumptionAmount</li> <li>• ConsumedElectricityReadingsFrom</li> <li>• ConsumedElectricityReadingsTo</li> <li>• ConsumptionConversionActCreateDate</li> <li>• ConsumptionConversionActFrom</li> <li>• ConsumptionConversionActNumber</li> </ul>

- ConsumptionConversionActTo
- ConsumptionState
- ConsumptionStateFrom
- ConsumptionStateTo
- EnergyObtainedConsumptionAmount
- EnergyObtainedDateFrom
- EnergyObtainedDateTo
- EnergyObtainedPowerKw
- GridSuppliedConsumptionAmount
- GridSuppliedReadingsFrom
- GridSuppliedReadingsTo
- InstalledConsumptionPower
- InstalledGeneratingPower
- PaymentType
- PowerPlantCapacityAmountNoVAT
- PowerPlantCapacityConsumptionAmount
- PowerPlantCapacityDateFrom
- PowerPlantCapacityDateTo
- PowerPlantCapacityPriceEur
- PowerPlantCapacitySource
- PowerPlantCapacitySourceDateFrom
- PowerPlantCapacitySourceDateTo
- PowerPlantCapacityUnit
- ReportingPeriod
- Service

Renamed fields:

- ReadingsSourceTypeCodeDatahub to ReadingsSource
- PermanentHomePlusAmountNoVAT to PermanentHomePlusAmountNoVAT

Removed fields:

- MetersMalfunctionActCreateDate
- MetersMalfunctionActFrom
- MetersMalfunctionActNumber
- MetersMalfunctionActTo
- NotConsumeFrom
- NotConsumeTo
- TechnologicalCostsReadingsFrom

		<ul style="list-style-type: none"> <li>• TechnologicalCostsReadingsTo</li> </ul>
0.6.9	2021-02-10	<p>Updated JSON specification of POST /reports/accounting-data-pack-b2b-meters-level method. Added new fields:</p> <ul style="list-style-type: none"> <li>• DdSppdAmountNoVAT</li> <li>• DdSppdConsumptionAmount</li> <li>• DdSppdDiscount</li> <li>• DdSppdPriceEur</li> <li>• DdSppdUnit</li> <li>• MissingEnergySppdAmountNoVAT</li> <li>• MissingEnergySppdConsumptionAmount</li> <li>• MissingEnergySppdDiscount</li> <li>• MissingEnergySppdPriceEur</li> <li>• MissingEnergySppdUnit</li> <li>• NkSppdAmountNoVAT</li> <li>• NkSppdConsumptionAmount</li> <li>• NkSppdDiscount</li> <li>• NkSppdPriceEur</li> <li>• NkSppdUnit</li> <li>• VkSppdAmountNoVAT</li> <li>• VkSppdConsumptionAmount</li> <li>• VkSppdDiscount</li> <li>• VkSppdPriceEur</li> <li>• VkSppdUnit</li> </ul>
0.6.10	2020-02-15	<p>Updated JSON specification of POST /reports/accounting-data-pack-b2b-meters-level method. Added new fields:</p> <ul style="list-style-type: none"> <li>• DdDiscountAmountNoVAT</li> <li>• DdDiscountConsumptionAmount</li> <li>• DdDiscountDiscount</li> <li>• DdDiscountPriceEur</li> <li>• DdDiscountUnit</li> <li>• MissingEnergyDiscountAmountNoVAT</li> <li>• MissingEnergyDiscountConsumptionAmount</li> <li>• MissingEnergyDiscountDiscount</li> <li>• MissingEnergyDiscountPriceEur</li> <li>• MissingEnergyDiscountUnit</li> <li>• NkDiscountAmountNoVAT</li> </ul>



		<ul style="list-style-type: none"> <li>• NkDiscountConsumptionAmount</li> <li>• NkDiscountDiscount</li> <li>• NkDiscountPriceEur</li> <li>• NkDiscountUnit</li> <li>• VkDiscountAmountNoVAT</li> <li>• VkDiscountConsumptionAmount</li> <li>• VkDiscountDiscount</li> <li>• VkDiscountPriceEur</li> <li>• VkDiscountUnit</li> </ul>
0.6.11	2021-02-17	<p>Added additional rules and response errors in:</p> <ul style="list-style-type: none"> <li>▪ POST /reports/accounting-data-pack-b2c</li> <li>▪ POST /reports/accounting-data-pack-b2c-count</li> <li>▪ POST /reports/accounting-data-pack-b2b-meters-level</li> <li>▪ POST /reports/accounting-data-pack-b2b-meters-level-count</li> <li>▪ POST /reports/objects-data-pack</li> <li>▪ POST /reports/objects-data-pack-count</li> <li>▪ POST /reports/accounting-data-pack-b2b?first={integer}&amp;count={integer}</li> <li>▪ POST /reports/accounting-data-pack-b2b-count</li> </ul>
0.6.12	2021-03-03	<p>Added an additional response error No 13 in:</p> <ul style="list-style-type: none"> <li>▪ POST /gateway/supplier/send-declaration-data</li> </ul>
0.6.13	2021-03-05	<p>Edited the error message rule 8 of the notification creation and the 108 error message text in:</p> <ul style="list-style-type: none"> <li>• POST /supplier/v2/supplier-change-notifications (new)</li> </ul>
0.6.14	2021-03-12	<p>Edited the description of the 108 error message</p> <ul style="list-style-type: none"> <li>• POST /supplier/v2/supplier-change-notifications (new)</li> </ul>
0.6.15	2021-03-15	<p>Updated JSON specification of POST /reports/accounting-data-pack-b2c method. Added new fields:</p> <ul style="list-style-type: none"> <li>• D1ConsumedElectricityConsumptionAmount</li> <li>• D1ConsumedElectricityReadingsFrom</li> <li>• D1ConsumedElectricityReadingsTo</li> <li>• D1ConsumedElectricityUnit</li> </ul>

- D1MissingEnergyAmount
- D1MissingEnergyAmountNoVAT
- D1MissingEnergyConsumptionAmount
- D1MissingEnergyIncludedVAT
- D1MissingEnergyPriceEur
- D1MissingEnergyPriceEurVAT
- D1MissingEnergySppdAmount
- D1MissingEnergySppdAmountNoVAT
- D1MissingEnergySppdConsumptionAmount
- D1MissingEnergySppdIncludedVAT
- D1MissingEnergySppdPriceEur
- D1MissingEnergySppdPriceEurVAT
- D1MissingEnergySppdUnit
- D1MissingEnergyUnit
- D1MissingEnergyViapAmount
- D1MissingEnergyViapAmountNoVAT
- D1MissingEnergyViapConsumptionAmount
- D1MissingEnergyViapIncludedVAT
- D1MissingEnergyViapPriceEur
- D1MissingEnergyViapPriceEurVAT
- D1MissingEnergyViapUnit
- D1PayingRecoveredEnergyAmount
- D1PayingRecoveredEnergyAmountNoVAT
- D1PayingRecoveredEnergyConsumptionAmount
- D1PayingRecoveredEnergyIncludedVAT
- D1PayingRecoveredEnergyPriceEur
- D1PayingRecoveredEnergyPriceEurVAT
- D1PayingRecoveredEnergyUnit
- D1PayingRecoveredMixedAmount
- D1PayingRecoveredMixedAmountNoVAT
- D1PayingRecoveredMixedConsumptionAmount
- D1PayingRecoveredMixedIncludedVAT
- D1PayingRecoveredMixedPriceEur
- D1PayingRecoveredMixedPriceEurVAT
- D1PayingRecoveredMixedUnit
- D1PayingRecoveredPercentConsumptionAmount
- D1PayingRecoveredPercentUnit
- D1PayingRecoveredPowerConsumptionAmount
- D1PayingRecoveredPowerUnit
- D2ConsumedElectricityConsumptionAmount
- D2ConsumedElectricityReadingsFrom

- D2ConsumedElectricityReadingsTo
- D2ConsumedElectricityUnit
- D2MissingEnergyAmount
- D2MissingEnergyAmountNoVAT
- D2MissingEnergyConsumptionAmount
- D2MissingEnergyIncludedVAT
- D2MissingEnergyPriceEur
- D2MissingEnergyPriceEurVAT
- D2MissingEnergySppdAmount
- D2MissingEnergySppdAmountNoVAT
- D2MissingEnergySppdConsumptionAmount
- D2MissingEnergySppdIncludedVAT
- D2MissingEnergySppdPriceEur
- D2MissingEnergySppdPriceEurVAT
- D2MissingEnergySppdUnit
- D2MissingEnergyUnit
- D2MissingEnergyViapAmount
- D2MissingEnergyViapAmountNoVAT
- D2MissingEnergyViapConsumptionAmount
- D2MissingEnergyViapIncludedVAT
- D2MissingEnergyViapPriceEur
- D2MissingEnergyViapPriceEurVAT
- D2MissingEnergyViapUnit
- D2PayingRecoveredEnergyAmount
- D2PayingRecoveredEnergyAmountNoVAT
- D2PayingRecoveredEnergyConsumptionAmount
- D2PayingRecoveredEnergyIncludedVAT
- D2PayingRecoveredEnergyPriceEur
- D2PayingRecoveredEnergyPriceEurVAT
- D2PayingRecoveredEnergyUnit
- D2PayingRecoveredMixedAmount
- D2PayingRecoveredMixedAmountNoVAT
- D2PayingRecoveredMixedConsumptionAmount
- D2PayingRecoveredMixedIncludedVAT
- D2PayingRecoveredMixedPriceEur
- D2PayingRecoveredMixedPriceEurVAT
- D2PayingRecoveredMixedUnit
- D2PayingRecoveredPercentConsumptionAmount
- D2PayingRecoveredPercentUnit
- D2PayingRecoveredPowerConsumptionAmount
- D2PayingRecoveredPowerUnit

- DdConsumedElectricityConsumptionAmount
- DdConsumedElectricityReadingsFrom
- DdConsumedElectricityReadingsTo
- DdConsumedElectricityUnit
- DdMissingEnergyAmount
- DdMissingEnergyAmountNoVAT
- DdMissingEnergyConsumptionAmount
- DdMissingEnergyIncludedVAT
- DdMissingEnergyPriceEur
- DdMissingEnergyPriceEurVAT
- DdMissingEnergySppdAmount
- DdMissingEnergySppdAmountNoVAT
- DdMissingEnergySppdConsumptionAmount
- DdMissingEnergySppdIncludedVAT
- DdMissingEnergySppdPriceEur
- DdMissingEnergySppdPriceEurVAT
- DdMissingEnergySppdUnit
- DdMissingEnergyUnit
- DdMissingEnergyViapAmount
- DdMissingEnergyViapAmountNoVAT
- DdMissingEnergyViapConsumptionAmount
- DdMissingEnergyViapIncludedVAT
- DdMissingEnergyViapPriceEur
- DdMissingEnergyViapPriceEurVAT
- DdMissingEnergyViapUnit
- DdPayingRecoveredEnergyAmount
- DdPayingRecoveredEnergyAmountNoVAT
- DdPayingRecoveredEnergyConsumptionAmount
- DdPayingRecoveredEnergyIncludedVAT
- DdPayingRecoveredEnergyPriceEur
- DdPayingRecoveredEnergyPriceEurVAT
- DdPayingRecoveredEnergyUnit
- DdPayingRecoveredMixedAmount
- DdPayingRecoveredMixedAmountNoVAT
- DdPayingRecoveredMixedConsumptionAmount
- DdPayingRecoveredMixedIncludedVAT
- DdPayingRecoveredMixedPriceEur
- DdPayingRecoveredMixedPriceEurVAT
- DdPayingRecoveredMixedUnit
- DdPayingRecoveredPercentConsumptionAmount
- DdPayingRecoveredPercentUnit

- DdPayingRecoveredPowerConsumptionAmount
- DdPayingRecoveredPowerUnit
- N1ConsumedElectricityConsumptionAmount
- N1ConsumedElectricityReadingsFrom
- N1ConsumedElectricityReadingsTo
- N1ConsumedElectricityUnit
- N1MissingEnergyAmount
- N1MissingEnergyAmountNoVAT
- N1MissingEnergyConsumptionAmount
- N1MissingEnergyIncludedVAT
- N1MissingEnergyPriceEur
- N1MissingEnergyPriceEurVAT
- N1MissingEnergySppdAmount
- N1MissingEnergySppdAmountNoVAT
- N1MissingEnergySppdConsumptionAmount
- N1MissingEnergySppdIncludedVAT
- N1MissingEnergySppdPriceEur
- N1MissingEnergySppdPriceEurVAT
- N1MissingEnergySppdUnit
- N1MissingEnergyUnit
- N1MissingEnergyViapAmount
- N1MissingEnergyViapAmountNoVAT
- N1MissingEnergyViapConsumptionAmount
- N1MissingEnergyViapIncludedVAT
- N1MissingEnergyViapPriceEur
- N1MissingEnergyViapPriceEurVAT
- N1MissingEnergyViapUnit
- N1PayingRecoveredEnergyAmount
- N1PayingRecoveredEnergyAmountNoVAT
- N1PayingRecoveredEnergyConsumptionAmount
- N1PayingRecoveredEnergyIncludedVAT
- N1PayingRecoveredEnergyPriceEur
- N1PayingRecoveredEnergyPriceEurVAT
- N1PayingRecoveredEnergyUnit
- N1PayingRecoveredMixedAmount
- N1PayingRecoveredMixedAmountNoVAT
- N1PayingRecoveredMixedConsumptionAmount
- N1PayingRecoveredMixedIncludedVAT
- N1PayingRecoveredMixedPriceEur
- N1PayingRecoveredMixedPriceEurVAT
- N1PayingRecoveredMixedUnit

- N1PayingRecoveredPercentConsumptionAmount
- N1PayingRecoveredPercentUnit
- N1PayingRecoveredPowerConsumptionAmount
- N1PayingRecoveredPowerUnit
- N2ConsumedElectricityConsumptionAmount
- N2ConsumedElectricityReadingsFrom
- N2ConsumedElectricityReadingsTo
- N2ConsumedElectricityUnit
- N2MissingEnergyAmount
- N2MissingEnergyAmountNoVAT
- N2MissingEnergyConsumptionAmount
- N2MissingEnergyIncludedVAT
- N2MissingEnergyPriceEur
- N2MissingEnergyPriceEurVAT
- N2MissingEnergySppdAmount
- N2MissingEnergySppdAmountNoVAT
- N2MissingEnergySppdConsumptionAmount
- N2MissingEnergySppdIncludedVAT
- N2MissingEnergySppdPriceEur
- N2MissingEnergySppdPriceEurVAT
- N2MissingEnergySppdUnit
- N2MissingEnergyUnit
- N2MissingEnergyViapAmount
- N2MissingEnergyViapAmountNoVAT
- N2MissingEnergyViapConsumptionAmount
- N2MissingEnergyViapIncludedVAT
- N2MissingEnergyViapPriceEur
- N2MissingEnergyViapPriceEurVAT
- N2MissingEnergyViapUnit
- N2PayingRecoveredEnergyAmount
- N2PayingRecoveredEnergyAmountNoVAT
- N2PayingRecoveredEnergyConsumptionAmount
- N2PayingRecoveredEnergyIncludedVAT
- N2PayingRecoveredEnergyPriceEur
- N2PayingRecoveredEnergyPriceEurVAT
- N2PayingRecoveredEnergyUnit
- N2PayingRecoveredMixedAmount
- N2PayingRecoveredMixedAmountNoVAT
- N2PayingRecoveredMixedConsumptionAmount
- N2PayingRecoveredMixedIncludedVAT
- N2PayingRecoveredMixedPriceEur

- N2PayingRecoveredMixedPriceEurVAT
- N2PayingRecoveredMixedUnit
- N2PayingRecoveredPercentConsumptionAmount
- N2PayingRecoveredPercentUnit
- N2PayingRecoveredPowerConsumptionAmount
- N2PayingRecoveredPowerUnit
- NkConsumedElectricityConsumptionAmount
- NkConsumedElectricityReadingsFrom
- NkConsumedElectricityReadingsTo
- NkConsumedElectricityUnit
- NkMissingEnergyAmount
- NkMissingEnergyAmountNoVAT
- NkMissingEnergyConsumptionAmount
- NkMissingEnergyIncludedVAT
- NkMissingEnergyPriceEur
- NkMissingEnergyPriceEurVAT
- NkMissingEnergySppdAmount
- NkMissingEnergySppdAmountNoVAT
- NkMissingEnergySppdConsumptionAmount
- NkMissingEnergySppdIncludedVAT
- NkMissingEnergySppdPriceEur
- NkMissingEnergySppdPriceEurVAT
- NkMissingEnergySppdUnit
- NkMissingEnergyUnit
- NkMissingEnergyViapAmount
- NkMissingEnergyViapAmountNoVAT
- NkMissingEnergyViapConsumptionAmount
- NkMissingEnergyViapIncludedVAT
- NkMissingEnergyViapPriceEur
- NkMissingEnergyViapPriceEurVAT
- NkMissingEnergyViapUnit
- NkPayingRecoveredEnergyAmount
- NkPayingRecoveredEnergyAmountNoVAT
- NkPayingRecoveredEnergyConsumptionAmount
- NkPayingRecoveredEnergyIncludedVAT
- NkPayingRecoveredEnergyPriceEur
- NkPayingRecoveredEnergyPriceEurVAT
- NkPayingRecoveredEnergyUnit
- NkPayingRecoveredMixedAmount
- NkPayingRecoveredMixedAmountNoVAT
- NkPayingRecoveredMixedConsumptionAmount

- NkPayingRecoveredMixedIncludedVAT
- NkPayingRecoveredMixedPriceEur
- NkPayingRecoveredMixedPriceEurVAT
- NkPayingRecoveredMixedUnit
- NkPayingRecoveredPercentConsumptionAmount
- NkPayingRecoveredPercentUnit
- NkPayingRecoveredPowerConsumptionAmount
- NkPayingRecoveredPowerUnit

Renamed fields (added Vk prefix):

- VkConsumedElectricityConsumptionAmount
- VkConsumedElectricityReadingsFrom
- VkConsumedElectricityReadingsTo
- VkConsumedElectricityUnit
- VkMissingEnergyAmount
- VkMissingEnergyAmountNoVAT
- VkMissingEnergyConsumptionAmount
- VkMissingEnergyDiscount
- VkMissingEnergyIncludedVAT
- VkMissingEnergyPriceEur
- VkMissingEnergyPriceEurVAT
- VkMissingEnergySppdAmount
- VkMissingEnergySppdAmountNoVAT
- VkMissingEnergySppdConsumptionAmount
- VkMissingEnergySppdDiscount
- VkMissingEnergySppdIncludedVAT
- VkMissingEnergySppdPriceEur
- VkMissingEnergySppdPriceEurVAT
- VkMissingEnergySppdUnit
- VkMissingEnergyUnit
- VkMissingEnergyViapAmount
- VkMissingEnergyViapAmountNoVAT
- VkMissingEnergyViapConsumptionAmount
- VkMissingEnergyViapDiscount
- VkMissingEnergyViapIncludedVAT
- VkMissingEnergyViapPriceEur
- VkMissingEnergyViapPriceEurVAT
- VkMissingEnergyViapUnit
- VkPayingRecoveredEnergyAmount



		<ul style="list-style-type: none"> <li>• VkPayingRecoveredEnergyAmountNoVAT</li> <li>• VkPayingRecoveredEnergyConsumptionAmount</li> <li>• VkPayingRecoveredEnergyDiscount</li> <li>• VkPayingRecoveredEnergyIncludedVAT</li> <li>• VkPayingRecoveredEnergyPriceEur</li> <li>• VkPayingRecoveredEnergyPriceEurVAT</li> <li>• VkPayingRecoveredEnergyUnit</li> <li>• VkPayingRecoveredMixedAmount</li> <li>• VkPayingRecoveredMixedAmountNoVAT</li> <li>• VkPayingRecoveredMixedConsumptionAmount</li> <li>• VkPayingRecoveredMixedDiscount</li> <li>• VkPayingRecoveredMixedIncludedVAT</li> <li>• VkPayingRecoveredMixedPriceEur</li> <li>• VkPayingRecoveredMixedPriceEurVAT</li> <li>• VkPayingRecoveredMixedUnit</li> <li>• VkPayingRecoveredPercentConsumptionAmount</li> <li>• VkPayingRecoveredPercentUnit</li> <li>• VkPayingRecoveredPowerConsumptionAmount</li> <li>• VkPayingRecoveredPowerUnit</li> </ul>
0.6.16	2021-03-16	<p>Updated JSON specification of POST /reports/accounting-data-pack-b2b-meters-level method. Added new fields:</p> <ul style="list-style-type: none"> <li>• DdConsumedElectricityConsumptionAmount</li> <li>• DdConsumedElectricityUnit</li> <li>• DdConsumedElectricityReadingsFrom</li> <li>• DdConsumedElectricityReadingsTo</li> <li>• NkConsumedElectricityConsumptionAmount</li> <li>• NkConsumedElectricityUnit</li> <li>• NkConsumedElectricityReadingsFrom</li> <li>• NkConsumedElectricityReadingsTo</li> <li>• MaConsumedElectricityConsumptionAmount</li> <li>• MaConsumedElectricityUnit</li> <li>• MaConsumedElectricityReadingsFrom</li> <li>• MaConsumedElectricityReadingsTo</li> <li>• VdConsumedElectricityConsumptionAmount</li> <li>• VdConsumedElectricityUnit</li> <li>• VdConsumedElectricityReadingsFrom</li> <li>• VdConsumedElectricityReadingsTo</li> <li>• SvConsumedElectricityConsumptionAmount</li> <li>• SvConsumedElectricityUnit</li> </ul>

- SvConsumedElectricityReadingsFrom
- SvConsumedElectricityReadingsTo
- MiConsumedElectricityConsumptionAmount
- MiConsumedElectricityUnit
- MiConsumedElectricityReadingsFrom
- MiConsumedElectricityReadingsTo
- DdPayingRecoveredEnergyConsumptionAmount
- DdPayingRecoveredEnergyUnit
- DdPayingRecoveredEnergyPriceEur
- DdPayingRecoveredEnergyAmountNoVAT
- NkPayingRecoveredEnergyConsumptionAmount
- NkPayingRecoveredEnergyUnit
- NkPayingRecoveredEnergyPriceEur
- NkPayingRecoveredEnergyAmountNoVAT
- MaPayingRecoveredEnergyConsumptionAmount
- MaPayingRecoveredEnergyUnit
- MaPayingRecoveredEnergyPriceEur
- MaPayingRecoveredEnergyAmountNoVAT
- VdPayingRecoveredEnergyConsumptionAmount
- VdPayingRecoveredEnergyUnit
- VdPayingRecoveredEnergyPriceEur
- VdPayingRecoveredEnergyAmountNoVAT
- SvPayingRecoveredEnergyConsumptionAmount
- SvPayingRecoveredEnergyUnit
- SvPayingRecoveredEnergyPriceEur
- SvPayingRecoveredEnergyAmountNoVAT
- MiPayingRecoveredEnergyConsumptionAmount
- MiPayingRecoveredEnergyUnit
- MiPayingRecoveredEnergyPriceEur
- MiPayingRecoveredEnergyAmountNoVAT
- DdPayingRecoveredPercentConsumptionAmount
- DdPayingRecoveredPercentUnit
- NkPayingRecoveredPercentConsumptionAmount
- NkPayingRecoveredPercentUnit
- MaPayingRecoveredPercentConsumptionAmount
- MaPayingRecoveredPercentUnit
- VdPayingRecoveredPercentConsumptionAmount
- VdPayingRecoveredPercentUnit
- SvPayingRecoveredPercentConsumptionAmount
- SvPayingRecoveredPercentUnit
- MiPayingRecoveredPercentConsumptionAmount

- MiPayingRecoveredPercentUnit
- DdPayingRecoveredPowerConsumptionAmount
- DdPayingRecoveredPowerUnit
- NkPayingRecoveredPowerConsumptionAmount
- NkPayingRecoveredPowerUnit
- MaPayingRecoveredPowerConsumptionAmount
- MaPayingRecoveredPowerUnit
- VdPayingRecoveredPowerConsumptionAmount
- VdPayingRecoveredPowerUnit
- SvPayingRecoveredPowerConsumptionAmount
- SvPayingRecoveredPowerUnit
- MiPayingRecoveredPowerConsumptionAmount
- MiPayingRecoveredPowerUnit
- DdPayingRecoveredMixedConsumptionAmount
- DdPayingRecoveredMixedUnit
- DdPayingRecoveredMixedPriceEur
- DdPayingRecoveredMixedAmountNoVAT
- NkPayingRecoveredMixedConsumptionAmount
- NkPayingRecoveredMixedUnit
- NkPayingRecoveredMixedPriceEur
- NkPayingRecoveredMixedAmountNoVAT
- MaPayingRecoveredMixedConsumptionAmount
- MaPayingRecoveredMixedUnit
- MaPayingRecoveredMixedPriceEur
- MaPayingRecoveredMixedAmountNoVAT
- VdPayingRecoveredMixedConsumptionAmount
- VdPayingRecoveredMixedUnit
- VdPayingRecoveredMixedPriceEur
- VdPayingRecoveredMixedAmountNoVAT
- SvPayingRecoveredMixedConsumptionAmount
- SvPayingRecoveredMixedUnit
- SvPayingRecoveredMixedPriceEur
- SvPayingRecoveredMixedAmountNoVAT
- MiPayingRecoveredMixedConsumptionAmount
- MiPayingRecoveredMixedUnit
- MiPayingRecoveredMixedPriceEur
- MiPayingRecoveredMixedAmountNoVAT
- DdMissingEnergyConsumptionAmount
- DdMissingEnergyUnit
- DdMissingEnergyPriceEur
- DdMissingEnergyAmountNoVAT

- NkMissingEnergyConsumptionAmount
- NkMissingEnergyUnit
- NkMissingEnergyPriceEur
- NkMissingEnergyAmountNoVAT
- MaMissingEnergyConsumptionAmount
- MaMissingEnergyUnit
- MaMissingEnergyPriceEur
- MaMissingEnergyAmountNoVAT
- VdMissingEnergyConsumptionAmount
- VdMissingEnergyUnit
- VdMissingEnergyPriceEur
- VdMissingEnergyAmountNoVAT
- SvMissingEnergyConsumptionAmount
- SvMissingEnergyUnit
- SvMissingEnergyPriceEur
- SvMissingEnergyAmountNoVAT
- MiMissingEnergyConsumptionAmount
- MiMissingEnergyUnit
- MiMissingEnergyPriceEur
- MiMissingEnergyAmountNoVAT
- DdMissingEnergyViapConsumptionAmount
- DdMissingEnergyViapUnit
- DdMissingEnergyViapPriceEur
- DdMissingEnergyViapAmountNoVAT
- NkMissingEnergyViapConsumptionAmount
- NkMissingEnergyViapUnit
- NkMissingEnergyViapPriceEur
- NkMissingEnergyViapAmountNoVAT
- MaMissingEnergyViapConsumptionAmount
- MaMissingEnergyViapUnit
- MaMissingEnergyViapPriceEur
- MaMissingEnergyViapAmountNoVAT
- VdMissingEnergyViapConsumptionAmount
- VdMissingEnergyViapUnit
- VdMissingEnergyViapPriceEur
- VdMissingEnergyViapAmountNoVAT
- SvMissingEnergyViapConsumptionAmount
- SvMissingEnergyViapUnit
- SvMissingEnergyViapPriceEur
- SvMissingEnergyViapAmountNoVAT
- MiMissingEnergyViapConsumptionAmount

- MiMissingEnergyViapUnit
- MiMissingEnergyViapPriceEur
- MiMissingEnergyViapAmountNoVAT
- DdMissingEnergySppdConsumptionAmount
- DdMissingEnergySppdUnit
- DdMissingEnergySppdPriceEur
- DdMissingEnergySppdAmountNoVAT
- NkMissingEnergySppdConsumptionAmount
- NkMissingEnergySppdUnit
- NkMissingEnergySppdPriceEur
- NkMissingEnergySppdAmountNoVAT
- DdMissingEnergyDiscountConsumptionAmount
- DdMissingEnergyDiscountUnit
- DdMissingEnergyDiscountPriceEur
- DdMissingEnergyDiscountAmountNoVAT
- NkMissingEnergyDiscountConsumptionAmount
- NkMissingEnergyDiscountUnit
- NkMissingEnergyDiscountPriceEur
- NkMissingEnergyDiscountAmountNoVAT

Renamed fields (added Vk prefix):

- VkConsumedElectricityConsumptionAmount
- VkConsumedElectricityUnit
- VkConsumedElectricityReadingsFrom
- VkConsumedElectricityReadingsTo
- VkPayingRecoveredEnergyConsumptionAmount
- VkPayingRecoveredEnergyUnit
- VkPayingRecoveredEnergyPriceEur
- VkPayingRecoveredEnergyDiscount
- VkPayingRecoveredEnergyAmountNoVAT
- VkPayingRecoveredPercentConsumptionAmount
- VkPayingRecoveredPercentUnit
- VkPayingRecoveredPowerConsumptionAmount
- VkPayingRecoveredPowerUnit
- VkPayingRecoveredMixedConsumptionAmount
- VkPayingRecoveredMixedUnit
- VkPayingRecoveredMixedPriceEur
- VkPayingRecoveredMixedDiscount
- VkPayingRecoveredMixedAmountNoVAT

		<ul style="list-style-type: none"> <li>• VkMissingEnergyConsumptionAmount</li> <li>• VkMissingEnergyUnit</li> <li>• VkMissingEnergyPriceEur</li> <li>• VkMissingEnergyDiscount</li> <li>• VkMissingEnergyAmountNoVAT</li> <li>• VkMissingEnergyViapConsumptionAmount</li> <li>• VkMissingEnergyViapUnit</li> <li>• VkMissingEnergyViapPriceEur</li> <li>• VkMissingEnergyViapDiscount</li> <li>• VkMissingEnergyViapAmountNoVAT</li> <li>• VkMissingEnergySppdConsumptionAmount</li> <li>• VkMissingEnergySppdUnit</li> <li>• VkMissingEnergySppdPriceEur</li> <li>• VkMissingEnergySppdDiscount</li> <li>• VkMissingEnergySppdAmountNoVAT</li> <li>• VkMissingEnergyDiscountConsumptionAmount</li> <li>• VkMissingEnergyDiscountUnit</li> <li>• VkMissingEnergyDiscountPriceEur</li> <li>• VkMissingEnergyDiscountDiscount</li> <li>• VkMissingEnergyDiscountAmountNoVAT</li> </ul>
0.6.17	2021-03-17	<p>Supplemented 11 rule and 9 response error in:</p> <ul style="list-style-type: none"> <li>▪ POST /gateway/supplier/send-declaration-data</li> </ul>
0.6.18	2021-03-22	<p>Added new method:</p> <ul style="list-style-type: none"> <li>▪ GET /gateway/supplier/v3/get-declaration-data?first={integer}&amp;count={integer}&amp;customerId={string}&amp;objectNumber={string}</li> </ul>
0.6.19	2021-03-23	<p>Added the new error message 44 and edited rule description 4</p> <ul style="list-style-type: none"> <li>• POST /supplier/v2/supplier-change-notifications (new)</li> </ul>
0.6.20	2021-03-25	<p>Added the new 9 error message and a new 2 rule description</p> <ul style="list-style-type: none"> <li>• POST /data/data-orders</li> </ul>
0.6.21	2021-04-06	<p>Added 423 rule and description in:</p>

		<ul style="list-style-type: none"> <li>• POST /reports/accounting-data-pack-b2c</li> <li>• POST /reports/accounting-data-pack-b2c-count</li> <li>• POST /reports/accounting-data-pack-b2b-meters-level</li> <li>• POST /reports/accounting-data-pack-b2b-meters-level-count</li> <li>• POST /reports/objects-data-pack</li> <li>• POST /reports/objects-data-pack-count</li> <li>• POST /reports/accounting-data-pack-b2b?first={integer}&amp;count={integer}</li> <li>• POST /reports/accounting-data-pack-b2b-count</li> </ul>
0.6.22	2021-04-06	<p>(will be deployed in next sprint) Added the description of the first rule.</p> <ul style="list-style-type: none"> <li>• POST /gateway/supplier/send-declaration-data</li> </ul>
0.6.23	2021-04-13	<p>Updated JSON specification of POST /reports/accounting-data-pack-b2c method and POST /reports/accounting-data-pack-b2b-meters-level method. Added new fields:</p> <ul style="list-style-type: none"> <li>▪ CompensatedConsumptionAmount</li> <li>▪ OldIndependentSupplier</li> </ul>
0.6.24	2021-04-21	<p>Updated JSON specification of POST /reports/accounting-data-pack-b2c method.</p> <p>Changed json fields ordering:</p> <ul style="list-style-type: none"> <li>• CustomerID</li> <li>• ClientID</li> <li>• ClientName</li> <li>• ClientAddress</li> <li>• ObjectID</li> <li>• ObjectNumber</li> <li>• ObjectName</li> <li>• ObjectType</li> <li>• ObjectAddress</li> <li>• AgreementType</li> <li>• AgreementModel</li> <li>• AgreementFrom</li> <li>• AgreementTo</li> <li>• PermissiblePowerConsumption</li> <li>• PermissiblePowerGeneration</li> <li>• InstalledGeneratingPower</li> </ul>

- InstalledConsumptionPower
- MetersAmount
- AutoMetersAmount
- ReportingPeriod
- BillingPeriod
- SupplyState
- SupplyStateFrom
- SupplyStateTo
- MetersNumber
- ReadingsSource
- ReadingsReceiveDate
- PaymentType
- Service
- DeclarationReferenceType
- ReferenceSubmitDate
- ReadingsSubmitDate
- DeclarationReferenceNumber
- UnaccountedConsumptionActNumber
- UnaccountedConsumptionActCreateDate
- UnaccountedConsumptionActFrom
- UnaccountedConsumptionActTo
- ConsumptionConversionActNumber
- ConsumptionConversionActCreateDate
- ConsumptionConversionActFrom
- ConsumptionConversionActTo
- ConsumptionState
- ConsumptionStateFrom
- ConsumptionStateTo
- TariffPlan
- TariffPlanChangeDate
- ConsumptionConversionAct
- PowerPlantCapacityDateFrom
- EnergyObtainedDateFrom
- PowerPlantCapacityDateTo
- EnergyObtainedDateTo
- EnergyObtainedPowerKw
- OperatorGridElectricityPercent
- ClientGridElectricityPercent
- VkConsumptionAmount
- VkViapConsumptionAmount
- VkSppdConsumptionAmount



- DdConsumptionAmount
- DdViapConsumptionAmount
- DdSppdConsumptionAmount
- NkConsumptionAmount
- NkViapConsumptionAmount
- NkSppdConsumptionAmount
- N2ConsumptionAmount
- N2ViapConsumptionAmount
- N2SppdConsumptionAmount
- D1ConsumptionAmount
- D1ViapConsumptionAmount
- D1SppdConsumptionAmount
- D2ConsumptionAmount
- D2ViapConsumptionAmount
- D2SppdConsumptionAmount
- N1ConsumptionAmount
- N1ViapConsumptionAmount
- N1SppdConsumptionAmount
- VkConsumedElectricityConsumptionAmount
- DdConsumedElectricityConsumptionAmount
- NkConsumedElectricityConsumptionAmount
- N2ConsumedElectricityConsumptionAmount
- D1ConsumedElectricityConsumptionAmount
- D2ConsumedElectricityConsumptionAmount
- N1ConsumedElectricityConsumptionAmount
- VkPayingRecoveredEnergyConsumptionAmount
- DdPayingRecoveredEnergyConsumptionAmount
- NkPayingRecoveredEnergyConsumptionAmount
- N2PayingRecoveredEnergyConsumptionAmount
- D1PayingRecoveredEnergyConsumptionAmount
- D2PayingRecoveredEnergyConsumptionAmount
- N1PayingRecoveredEnergyConsumptionAmount
- VkPayingRecoveredPercentConsumptionAmount
- DdPayingRecoveredPercentConsumptionAmount
- NkPayingRecoveredPercentConsumptionAmount
- N2PayingRecoveredPercentConsumptionAmount
- D1PayingRecoveredPercentConsumptionAmount
- D2PayingRecoveredPercentConsumptionAmount
- N1PayingRecoveredPercentConsumptionAmount
- VkPayingRecoveredPowerConsumptionAmount
- DdPayingRecoveredPowerConsumptionAmount

- NkPayingRecoveredPowerConsumptionAmount
- N2PayingRecoveredPowerConsumptionAmount
- D1PayingRecoveredPowerConsumptionAmount
- D2PayingRecoveredPowerConsumptionAmount
- N1PayingRecoveredPowerConsumptionAmount
- VkPayingRecoveredMixedConsumptionAmount
- DdPayingRecoveredMixedConsumptionAmount
- NkPayingRecoveredMixedConsumptionAmount
- N2PayingRecoveredMixedConsumptionAmount
- D1PayingRecoveredMixedConsumptionAmount
- D2PayingRecoveredMixedConsumptionAmount
- N1PayingRecoveredMixedConsumptionAmount
- VkMissingEnergyConsumptionAmount
- VkMissingEnergyViapConsumptionAmount
- VkMissingEnergySppdConsumptionAmount
- DdMissingEnergyConsumptionAmount
- DdMissingEnergyViapConsumptionAmount
- DdMissingEnergySppdConsumptionAmount
- NkMissingEnergyConsumptionAmount
- NkMissingEnergyViapConsumptionAmount
- NkMissingEnergySppdConsumptionAmount
- N2MissingEnergyConsumptionAmount
- N2MissingEnergyViapConsumptionAmount
- N2MissingEnergySppdConsumptionAmount
- D1MissingEnergyConsumptionAmount
- D1MissingEnergyViapConsumptionAmount
- D1MissingEnergySppdConsumptionAmount
- D2MissingEnergyConsumptionAmount
- D2MissingEnergyViapConsumptionAmount
- D2MissingEnergySppdConsumptionAmount
- N1MissingEnergyConsumptionAmount
- N1MissingEnergyViapConsumptionAmount
- N1MissingEnergySppdConsumptionAmount
- GridSuppliedConsumptionAmount
- AccumulatedBeginningConsumptionAmount
- AccumulatedEndConsumptionAmount
- AccumulatedTransferredConsumptionAmount
- AccumulatedUploadedConsumptionAmount
- AccumulatedRaisedConsumptionAmount
- CompensatedConsumptionAmount
- OldIndependentSupplier

- PowerPlantCapacityConsumptionAmount
- EnergyObtainedConsumptionAmount
- OperatorGridElectricityConsumptionAmount
- ClientGridElectricityConsumptionAmount
- VkUnit
- VkViapUnit
- VkSppdUnit
- DdUnit
- DdViapUnit
- DdSppdUnit
- NkUnit
- NkViapUnit
- NkSppdUnit
- N2Unit
- N2ViapUnit
- N2SppdUnit
- D1Unit
- D1ViapUnit
- D1SppdUnit
- D2Unit
- D2ViapUnit
- D2SppdUnit
- N1Unit
- N1ViapUnit
- N1SppdUnit
- VkConsumedElectricityUnit
- DdConsumedElectricityUnit
- NkConsumedElectricityUnit
- N2ConsumedElectricityUnit
- D1ConsumedElectricityUnit
- D2ConsumedElectricityUnit
- N1ConsumedElectricityUnit
- VkPayingRecoveredEnergyUnit
- DdPayingRecoveredEnergyUnit
- NkPayingRecoveredEnergyUnit
- N2PayingRecoveredEnergyUnit
- D1PayingRecoveredEnergyUnit
- D2PayingRecoveredEnergyUnit
- N1PayingRecoveredEnergyUnit
- VkPayingRecoveredPercentUnit
- DdPayingRecoveredPercentUnit

- NkPayingRecoveredPercentUnit
- N2PayingRecoveredPercentUnit
- D1PayingRecoveredPercentUnit
- D2PayingRecoveredPercentUnit
- N1PayingRecoveredPercentUnit
- VkPayingRecoveredPowerUnit
- DdPayingRecoveredPowerUnit
- NkPayingRecoveredPowerUnit
- N2PayingRecoveredPowerUnit
- D1PayingRecoveredPowerUnit
- D2PayingRecoveredPowerUnit
- N1PayingRecoveredPowerUnit
- VkPayingRecoveredMixedUnit
- DdPayingRecoveredMixedUnit
- NkPayingRecoveredMixedUnit
- N2PayingRecoveredMixedUnit
- D1PayingRecoveredMixedUnit
- D2PayingRecoveredMixedUnit
- N1PayingRecoveredMixedUnit
- VkMissingEnergyUnit
- VkMissingEnergyViapUnit
- VkMissingEnergySppdUnit
- DdMissingEnergyUnit
- DdMissingEnergyViapUnit
- DdMissingEnergySppdUnit
- NkMissingEnergyUnit
- NkMissingEnergyViapUnit
- NkMissingEnergySppdUnit
- N2MissingEnergyUnit
- N2MissingEnergyViapUnit
- N2MissingEnergySppdUnit
- D1MissingEnergyUnit
- D1MissingEnergyViapUnit
- D1MissingEnergySppdUnit
- D2MissingEnergyUnit
- D2MissingEnergyViapUnit
- D2MissingEnergySppdUnit
- N1MissingEnergyUnit
- N1MissingEnergyViapUnit
- N1MissingEnergySppdUnit
- VkReadingsFrom

- DdReadingsFrom
- NkReadingsFrom
- N2ReadingsFrom
- D1ReadingsFrom
- D2ReadingsFrom
- N1ReadingsFrom
- VkConsumedElectricityReadingsFrom
- DdConsumedElectricityReadingsFrom
- NkConsumedElectricityReadingsFrom
- N2ConsumedElectricityReadingsFrom
- D1ConsumedElectricityReadingsFrom
- D2ConsumedElectricityReadingsFrom
- N1ConsumedElectricityReadingsFrom
- GridSuppliedReadingsFrom
- VkReadingsTo
- DdReadingsTo
- NkReadingsTo
- N2ReadingsTo
- D1ReadingsTo
- D2ReadingsTo
- N1ReadingsTo
- VkConsumedElectricityReadingsTo
- DdConsumedElectricityReadingsTo
- NkConsumedElectricityReadingsTo
- N2ConsumedElectricityReadingsTo
- D1ConsumedElectricityReadingsTo
- D2ConsumedElectricityReadingsTo
- N1ConsumedElectricityReadingsTo
- GridSuppliedReadingsTo
- VkPriceEur
- VkViapPriceEur
- VkSppdPriceEur
- DdPriceEur
- DdViapPriceEur
- DdSppdPriceEur
- NkPriceEur
- NkViapPriceEur
- NkSppdPriceEur
- N2PriceEur
- N2ViapPriceEur
- N2SppdPriceEur

- D1PriceEur
- D1ViapPriceEur
- D1SppdPriceEur
- D2PriceEur
- D2ViapPriceEur
- D2SppdPriceEur
- N1PriceEur
- N1ViapPriceEur
- N1SppdPriceEur
- VkPayingRecoveredEnergyPriceEur
- DdPayingRecoveredEnergyPriceEur
- NkPayingRecoveredEnergyPriceEur
- N2PayingRecoveredEnergyPriceEur
- D1PayingRecoveredEnergyPriceEur
- D2PayingRecoveredEnergyPriceEur
- N1PayingRecoveredEnergyPriceEur
- VkPayingRecoveredMixedPriceEur
- DdPayingRecoveredMixedPriceEur
- NkPayingRecoveredMixedPriceEur
- N2PayingRecoveredMixedPriceEur
- D1PayingRecoveredMixedPriceEur
- D2PayingRecoveredMixedPriceEur
- N1PayingRecoveredMixedPriceEur
- VkMissingEnergyPriceEur
- VkMissingEnergyViapPriceEur
- VkMissingEnergySppdPriceEur
- DdMissingEnergyPriceEur
- DdMissingEnergyViapPriceEur
- DdMissingEnergySppdPriceEur
- NkMissingEnergyPriceEur
- NkMissingEnergyViapPriceEur
- NkMissingEnergySppdPriceEur
- N2MissingEnergyPriceEur
- N2MissingEnergyViapPriceEur
- N2MissingEnergySppdPriceEur
- D1MissingEnergyPriceEur
- D1MissingEnergyViapPriceEur
- D1MissingEnergySppdPriceEur
- D2MissingEnergyPriceEur
- D2MissingEnergyViapPriceEur
- D2MissingEnergySppdPriceEur

- N1MissingEnergyPriceEur
- N1MissingEnergyViapPriceEur
- N1MissingEnergySppdPriceEur
- PowerPlantCapacityPriceEur
- VkPriceEurVAT
- VkViapPriceEurVAT
- VkSppdPriceEurVAT
- DdPriceEurVAT
- DdViapPriceEurVAT
- DdSppdPriceEurVAT
- NkPriceEurVAT
- NkViapPriceEurVAT
- NkSppdPriceEurVAT
- N2PriceEurVAT
- N2ViapPriceEurVAT
- N2SppdPriceEurVAT
- D1PriceEurVAT
- D1ViapPriceEurVAT
- D1SppdPriceEurVAT
- D2PriceEurVAT
- D2ViapPriceEurVAT
- D2SppdPriceEurVAT
- N1PriceEurVAT
- N1ViapPriceEurVAT
- N1SppdPriceEurVAT
- VkPayingRecoveredEnergyPriceEurVAT
- DdPayingRecoveredEnergyPriceEurVAT
- NkPayingRecoveredEnergyPriceEurVAT
- N2PayingRecoveredEnergyPriceEurVAT
- D1PayingRecoveredEnergyPriceEurVAT
- D2PayingRecoveredEnergyPriceEurVAT
- N1PayingRecoveredEnergyPriceEurVAT
- VkPayingRecoveredMixedPriceEurVAT
- DdPayingRecoveredMixedPriceEurVAT
- NkPayingRecoveredMixedPriceEurVAT
- N2PayingRecoveredMixedPriceEurVAT
- D1PayingRecoveredMixedPriceEurVAT
- D2PayingRecoveredMixedPriceEurVAT
- N1PayingRecoveredMixedPriceEurVAT
- VkMissingEnergyPriceEurVAT
- VkMissingEnergyViapPriceEurVAT

- VkMissingEnergySppdPriceEurVAT
- DdMissingEnergyPriceEurVAT
- DdMissingEnergyViapPriceEurVAT
- DdMissingEnergySppdPriceEurVAT
- NkMissingEnergyPriceEurVAT
- NkMissingEnergyViapPriceEurVAT
- NkMissingEnergySppdPriceEurVAT
- N2MissingEnergyPriceEurVAT
- N2MissingEnergyViapPriceEurVAT
- N2MissingEnergySppdPriceEurVAT
- D1MissingEnergyPriceEurVAT
- D1MissingEnergyViapPriceEurVAT
- D1MissingEnergySppdPriceEurVAT
- D2MissingEnergyPriceEurVAT
- D2MissingEnergyViapPriceEurVAT
- D2MissingEnergySppdPriceEurVAT
- N1MissingEnergyPriceEurVAT
- N1MissingEnergyViapPriceEurVAT
- N1MissingEnergySppdPriceEurVAT
- PowerPlantCapacityPriceEurVat
- VkDiscount
- VkViapDiscount
- VkSppdDiscount
- DdDiscount
- DdViapDiscount
- DdSppdDiscount
- NkDiscount
- NkViapDiscount
- NkSppdDiscount
- N2Discount
- N2ViapDiscount
- N2SppdDiscount
- D1Discount
- D1ViapDiscount
- D1SppdDiscount
- D2Discount
- D2ViapDiscount
- D2SppdDiscount
- N1Discount
- N1ViapDiscount
- N1SppdDiscount



		<ul style="list-style-type: none"> <li>• VkPayingRecoveredEnergyDiscount</li> <li>• VkPayingRecoveredMixedDiscount</li> <li>• VkMissingEnergyDiscount</li> <li>• VkMissingEnergyViapDiscount</li> <li>• VkMissingEnergySppdDiscount</li> <li>• FixedFeeAmountNoVAT</li> <li>• VkAmountNoVAT</li> <li>• VkViapAmountNoVAT</li> <li>• VkSppdAmountNoVAT</li> <li>• DdAmountNoVAT</li> <li>• DdViapAmountNoVAT</li> <li>• DdSppdAmountNoVAT</li> <li>• NkAmountNoVAT</li> <li>• NkViapAmountNoVAT</li> <li>• NkSppdAmountNoVAT</li> <li>• N2AmountNoVAT</li> <li>• N2ViapAmountNoVAT</li> <li>• N2SppdAmountNoVAT</li> <li>• D1AmountNoVAT</li> <li>• D1ViapAmountNoVAT</li> <li>• D1SppdAmountNoVAT</li> <li>• D2AmountNoVAT</li> <li>• D2ViapAmountNoVAT</li> <li>• D2SppdAmountNoVAT</li> <li>• N1AmountNoVAT</li> <li>• N1ViapAmountNoVAT</li> <li>• N1SppdAmountNoVAT</li> <li>• VkPayingRecoveredEnergyAmountNoVAT</li> <li>• DdPayingRecoveredEnergyAmountNoVAT</li> <li>• NkPayingRecoveredEnergyAmountNoVAT</li> <li>• N2PayingRecoveredEnergyAmountNoVAT</li> <li>• D1PayingRecoveredEnergyAmountNoVAT</li> <li>• D2PayingRecoveredEnergyAmountNoVAT</li> <li>• N1PayingRecoveredEnergyAmountNoVAT</li> <li>• VkPayingRecoveredMixedAmountNoVAT</li> <li>• DdPayingRecoveredMixedAmountNoVAT</li> <li>• NkPayingRecoveredMixedAmountNoVAT</li> <li>• N2PayingRecoveredMixedAmountNoVAT</li> <li>• D1PayingRecoveredMixedAmountNoVAT</li> <li>• D2PayingRecoveredMixedAmountNoVAT</li> <li>• N1PayingRecoveredMixedAmountNoVAT</li> </ul>
--	--	---

- VkMissingEnergyAmountNoVAT
- VkMissingEnergyViapAmountNoVAT
- VkMissingEnergySppdAmountNoVAT
- DdMissingEnergyAmountNoVAT
- DdMissingEnergyViapAmountNoVAT
- DdMissingEnergySppdAmountNoVAT
- NkMissingEnergyAmountNoVAT
- NkMissingEnergyViapAmountNoVAT
- NkMissingEnergySppdAmountNoVAT
- N2MissingEnergyAmountNoVAT
- N2MissingEnergyViapAmountNoVAT
- N2MissingEnergySppdAmountNoVAT
- D1MissingEnergyAmountNoVAT
- D1MissingEnergyViapAmountNoVAT
- D1MissingEnergySppdAmountNoVAT
- D2MissingEnergyAmountNoVAT
- D2MissingEnergyViapAmountNoVAT
- D2MissingEnergySppdAmountNoVAT
- N1MissingEnergyAmountNoVAT
- N1MissingEnergyViapAmountNoVAT
- N1MissingEnergySppdAmountNoVAT
- PowerPlantCapacityAmountNoVAT
- FixedFeeAmount
- VkAmount
- VkViapAmount
- VkSppdAmount
- DdAmount
- DdViapAmount
- DdSppdAmount
- NkAmount
- NkViapAmount
- NkSppdAmount
- N2Amount
- N2ViapAmount
- N2SppdAmount
- D1Amount
- D1ViapAmount
- D1SppdAmount
- D2Amount
- D2ViapAmount
- D2SppdAmount

- N1Amount
- N1ViapAmount
- N1SppdAmount
- VkPayingRecoveredEnergyAmount
- DdPayingRecoveredEnergyAmount
- NkPayingRecoveredEnergyAmount
- N2PayingRecoveredEnergyAmount
- D1PayingRecoveredEnergyAmount
- D2PayingRecoveredEnergyAmount
- N1PayingRecoveredEnergyAmount
- VkPayingRecoveredMixedAmount
- DdPayingRecoveredMixedAmount
- NkPayingRecoveredMixedAmount
- N2PayingRecoveredMixedAmount
- D1PayingRecoveredMixedAmount
- D2PayingRecoveredMixedAmount
- N1PayingRecoveredMixedAmount
- VkMissingEnergyAmount
- VkMissingEnergyViapAmount
- VkMissingEnergySppdAmount
- DdMissingEnergyAmount
- DdMissingEnergyViapAmount
- DdMissingEnergySppdAmount
- NkMissingEnergyAmount
- NkMissingEnergyViapAmount
- NkMissingEnergySppdAmount
- N2MissingEnergyAmount
- N2MissingEnergyViapAmount
- N2MissingEnergySppdAmount
- D1MissingEnergyAmount
- D1MissingEnergyViapAmount
- D1MissingEnergySppdAmount
- D2MissingEnergyAmount
- D2MissingEnergyViapAmount
- D2MissingEnergySppdAmount
- N1MissingEnergyAmount
- N1MissingEnergyViapAmount
- N1MissingEnergySppdAmount
- PowerPlantCapacityAmount
- FixedFeeIncludedVAT
- VkIncludedVAT

- VkViapIncludedVAT
- VkSppdIncludedVAT
- DdIncludedVAT
- DdViapIncludedVAT
- DdSppdIncludedVAT
- NkIncludedVAT
- NkViapIncludedVAT
- NkSppdIncludedVAT
- N2IncludedVAT
- N2ViapIncludedVAT
- N2SppdIncludedVAT
- D1IncludedVAT
- D1ViapIncludedVAT
- D1SppdIncludedVAT
- D2IncludedVAT
- D2ViapIncludedVAT
- D2SppdIncludedVAT
- N1IncludedVAT
- N1ViapIncludedVAT
- N1SppdIncludedVAT
- VkPayingRecoveredEnergyIncludedVAT
- DdPayingRecoveredEnergyIncludedVAT
- NkPayingRecoveredEnergyIncludedVAT
- N2PayingRecoveredEnergyIncludedVAT
- D1PayingRecoveredEnergyIncludedVAT
- D2PayingRecoveredEnergyIncludedVAT
- N1PayingRecoveredEnergyIncludedVAT
- VkPayingRecoveredMixedIncludedVAT
- DdPayingRecoveredMixedIncludedVAT
- NkPayingRecoveredMixedIncludedVAT
- N2PayingRecoveredMixedIncludedVAT
- D1PayingRecoveredMixedIncludedVAT
- D2PayingRecoveredMixedIncludedVAT
- N1PayingRecoveredMixedIncludedVAT
- VkMissingEnergyIncludedVAT
- VkMissingEnergyViapIncludedVAT
- VkMissingEnergySppdIncludedVAT
- DdMissingEnergyIncludedVAT
- DdMissingEnergyViapIncludedVAT
- DdMissingEnergySppdIncludedVAT
- NkMissingEnergyIncludedVAT

		<ul style="list-style-type: none"> <li>• NkMissingEnergyViapIncludedVAT</li> <li>• NkMissingEnergySppdIncludedVAT</li> <li>• N2MissingEnergyIncludedVAT</li> <li>• N2MissingEnergyViapIncludedVAT</li> <li>• N2MissingEnergySppdIncludedVAT</li> <li>• D1MissingEnergyIncludedVAT</li> <li>• D1MissingEnergyViapIncludedVAT</li> <li>• D1MissingEnergySppdIncludedVAT</li> <li>• D2MissingEnergyIncludedVAT</li> <li>• D2MissingEnergyViapIncludedVAT</li> <li>• D2MissingEnergySppdIncludedVAT</li> <li>• N1MissingEnergyIncludedVAT</li> <li>• N1MissingEnergyViapIncludedVAT</li> <li>• N1MissingEnergySppdIncludedVAT</li> <li>• PowerPlantCapacityIncludedVAT</li> <li>• PowerPlantCapacityUnit</li> </ul>
0.6.25	2021-04-21	<p>Updated JSON specification of POST /reports/accounting-data-pack-b2b-meters-level method.  Changed json fields ordering:</p> <ul style="list-style-type: none"> <li>• CustomerID</li> <li>• ClientID</li> <li>• ClientName</li> <li>• ClientAddress</li> <li>• ObjectID</li> <li>• ObjectNumber</li> <li>• ObjectName</li> <li>• ObjectType</li> <li>• ObjectAddress</li> <li>• AgreementType</li> <li>• AgreementModel</li> <li>• AgreementFrom</li> <li>• AgreementTo</li> <li>• PermittablePowerConsumption</li> <li>• PermittablePowerGeneration</li> <li>• InstalledGeneratingPower</li> <li>• InstalledConsumptionPower</li> <li>• MetersAmount</li> <li>• AutoMetersAmount</li> <li>• ReportingPeriod</li> <li>• BillingPeriod</li> </ul>

- SupplyState
- SupplyStateFrom
- SupplyStateTo
- MetersNumber
- ReadingsSource
- ReadingsReceiveDate
- PaymentType
- DeclarationReferenceType
- Service
- ReferenceSubmitDate
- ReadingsSubmitDate
- DeclarationReferenceNumber
- UnaccountedConsumptionActNumber
- UnaccountedConsumptionActCreateDate
- UnaccountedConsumptionActFrom
- UnaccountedConsumptionActTo
- ConsumptionConversionActNumber
- ConsumptionConversionActCreateDate
- ConsumptionConversionActFrom
- ConsumptionConversionActTo
- ConsumptionState
- ConsumptionStateFrom
- ConsumptionStateTo
- TariffPlan
- PowerPlantCapacityDateFrom
- EnergyObtainedDateFrom
- PowerPlantCapacityDateTo
- PowerPlantCapacitySource
- PowerPlantCapacitySourceDateFrom
- PowerPlantCapacitySourceDateTo
- EnergyObtainedDateTo
- EnergyObtainedPowerKw
- TariffPlanChangeDate
- ConsumptionConversionAct
- UnaccountedAct
- ConversionAct
- OperatorGridElectricityPercent
- ClientGridElectricityPercent
- GaConsumptionAmount
- VkConsumptionAmount
- VkViapConsumptionAmount

- VkSppdConsumptionAmount
- VkDiscountConsumptionAmount
- DdConsumptionAmount
- DdViapConsumptionAmount
- DdSppdConsumptionAmount
- DdDiscountConsumptionAmount
- NkConsumptionAmount
- NkViapConsumptionAmount
- NkSppdConsumptionAmount
- NkDiscountConsumptionAmount
- MaConsumptionAmount
- MaViapConsumptionAmount
- VdConsumptionAmount
- VdViapConsumptionAmount
- SvConsumptionAmount
- SvViapConsumptionAmount
- MiConsumptionAmount
- MiViapConsumptionAmount
- RvConsumptionAmount
- RgConsumptionAmount
- VgConsumptionAmount
- Reliability1ConsumptionAmount
- Reliability2ConsumptionAmount
- Reliability3ConsumptionAmount
- TechnologicalCostsViapConsumptionAmount
- TechnologicalCostsConsumptionAmount
- GeneralInterestConsumptionAmount
- VkConsumedElectricityConsumptionAmount
- DdConsumedElectricityConsumptionAmount
- NkConsumedElectricityConsumptionAmount
- MaConsumedElectricityConsumptionAmount
- VdConsumedElectricityConsumptionAmount
- SvConsumedElectricityConsumptionAmount
- MiConsumedElectricityConsumptionAmount
- VkPayingRecoveredEnergyConsumptionAmount
- DdPayingRecoveredEnergyConsumptionAmount
- NkPayingRecoveredEnergyConsumptionAmount
- MaPayingRecoveredEnergyConsumptionAmount
- VdPayingRecoveredEnergyConsumptionAmount
- SvPayingRecoveredEnergyConsumptionAmount
- MiPayingRecoveredEnergyConsumptionAmount

- VkPayingRecoveredPercentConsumptionAmount
- DdPayingRecoveredPercentConsumptionAmount
- NkPayingRecoveredPercentConsumptionAmount
- MaPayingRecoveredPercentConsumptionAmount
- VdPayingRecoveredPercentConsumptionAmount
- SvPayingRecoveredPercentConsumptionAmount
- MiPayingRecoveredPercentConsumptionAmount
- VkPayingRecoveredPowerConsumptionAmount
- DdPayingRecoveredPowerConsumptionAmount
- NkPayingRecoveredPowerConsumptionAmount
- MaPayingRecoveredPowerConsumptionAmount
- VdPayingRecoveredPowerConsumptionAmount
- SvPayingRecoveredPowerConsumptionAmount
- MiPayingRecoveredPowerConsumptionAmount
- VkPayingRecoveredMixedConsumptionAmount
- DdPayingRecoveredMixedConsumptionAmount
- NkPayingRecoveredMixedConsumptionAmount
- MaPayingRecoveredMixedConsumptionAmount
- VdPayingRecoveredMixedConsumptionAmount
- SvPayingRecoveredMixedConsumptionAmount
- MiPayingRecoveredMixedConsumptionAmount
- VkMissingEnergyConsumptionAmount
- VkMissingEnergyViapConsumptionAmount
- VkMissingEnergySppdConsumptionAmount
- DdMissingEnergyConsumptionAmount
- DdMissingEnergyViapConsumptionAmount
- DdMissingEnergySppdConsumptionAmount
- NkMissingEnergyConsumptionAmount
- NkMissingEnergyViapConsumptionAmount
- NkMissingEnergySppdConsumptionAmount
- MaMissingEnergyConsumptionAmount
- MaMissingEnergyViapConsumptionAmount
- VdMissingEnergyConsumptionAmount
- VdMissingEnergyViapConsumptionAmount
- SvMissingEnergyConsumptionAmount
- SvMissingEnergyViapConsumptionAmount
- MiMissingEnergyConsumptionAmount
- MiMissingEnergyViapConsumptionAmount
- VkMissingEnergyDiscountConsumptionAmount
- DdMissingEnergyDiscountConsumptionAmount
- NkMissingEnergyDiscountConsumptionAmount



- GridSuppliedConsumptionAmount
- AccumulatedBeginningConsumptionAmount
- AccumulatedEndConsumptionAmount
- AccumulatedTransferredConsumptionAmount
- AccumulatedUploadedConsumptionAmount
- AccumulatedRaisedConsumptionAmount
- CompensatedConsumptionAmount
- OldIndependentSupplier
- PowerPlantCapacityConsumptionAmount
- EnergyObtainedConsumptionAmount
- OperatorGridElectricityConsumptionAmount
- ClientGridElectricityConsumptionAmount
- PowerPlantCapacityUnit
- GaUnit
- VkUnit
- VkViapUnit
- VkSppdUnit
- VkDiscountUnit
- DdUnit
- DdViapUnit
- DdSppdUnit
- DdDiscountUnit
- NkUnit
- NkViapUnit
- NkSppdUnit
- NkDiscountUnit
- MaUnit
- MaViapUnit
- VdUnit
- VdViapUnit
- SvUnit
- SvViapUnit
- MiUnit
- MiViapUnit
- RvUnit
- RgUnit
- VgUnit
- Reliability1Unit
- Reliability2Unit
- Reliability3Unit
- TechnologicalCostsViapUnit

- TechnologicalCostsUnit
- GeneralInterestUnit
- VkConsumedElectricityUnit
- DdConsumedElectricityUnit
- NkConsumedElectricityUnit
- MaConsumedElectricityUnit
- VdConsumedElectricityUnit
- SvConsumedElectricityUnit
- MiConsumedElectricityUnit
- VkPayingRecoveredEnergyUnit
- DdPayingRecoveredEnergyUnit
- NkPayingRecoveredEnergyUnit
- MaPayingRecoveredEnergyUnit
- VdPayingRecoveredEnergyUnit
- SvPayingRecoveredEnergyUnit
- MiPayingRecoveredEnergyUnit
- VkPayingRecoveredPercentUnit
- DdPayingRecoveredPercentUnit
- NkPayingRecoveredPercentUnit
- MaPayingRecoveredPercentUnit
- VdPayingRecoveredPercentUnit
- SvPayingRecoveredPercentUnit
- MiPayingRecoveredPercentUnit
- VkPayingRecoveredPowerUnit
- DdPayingRecoveredPowerUnit
- NkPayingRecoveredPowerUnit
- MaPayingRecoveredPowerUnit
- VdPayingRecoveredPowerUnit
- SvPayingRecoveredPowerUnit
- MiPayingRecoveredPowerUnit
- VkPayingRecoveredMixedUnit
- DdPayingRecoveredMixedUnit
- NkPayingRecoveredMixedUnit
- MaPayingRecoveredMixedUnit
- VdPayingRecoveredMixedUnit
- SvPayingRecoveredMixedUnit
- MiPayingRecoveredMixedUnit
- VkMissingEnergyUnit
- VkMissingEnergyViapUnit
- VkMissingEnergySppdUnit
- DdMissingEnergyUnit

- DdMissingEnergyViapUnit
- DdMissingEnergySppdUnit
- NkMissingEnergyUnit
- NkMissingEnergyViapUnit
- NkMissingEnergySppdUnit
- MaMissingEnergyUnit
- MaMissingEnergyViapUnit
- VdMissingEnergyUnit
- VdMissingEnergyViapUnit
- SvMissingEnergyUnit
- SvMissingEnergyViapUnit
- MiMissingEnergyUnit
- MiMissingEnergyViapUnit
- VkMissingEnergyDiscountUnit
- DdMissingEnergyDiscountUnit
- NkMissingEnergyDiscountUnit
- VkReadingsFrom
- DdReadingsFrom
- NkReadingsFrom
- MaReadingsFrom
- VdReadingsFrom
- SvReadingsFrom
- MiReadingsFrom
- RvReadingsFrom
- RgReadingsFrom
- VkConsumedElectricityReadingsFrom
- DdConsumedElectricityReadingsFrom
- NkConsumedElectricityReadingsFrom
- MaConsumedElectricityReadingsFrom
- VdConsumedElectricityReadingsFrom
- SvConsumedElectricityReadingsFrom
- MiConsumedElectricityReadingsFrom
- GridSuppliedReadingsFrom
- VkReadingsTo
- DdReadingsTo
- NkReadingsTo
- MaReadingsTo
- VdReadingsTo
- SvReadingsTo
- MiReadingsTo
- RvReadingsTo

- RgReadingsTo
- VkConsumedElectricityReadingsTo
- DdConsumedElectricityReadingsTo
- NkConsumedElectricityReadingsTo
- MaConsumedElectricityReadingsTo
- VdConsumedElectricityReadingsTo
- SvConsumedElectricityReadingsTo
- MiConsumedElectricityReadingsTo
- GridSuppliedReadingsTo
- GaPriceEur
- VkPriceEur
- VkViapPriceEur
- VkSppdPriceEur
- VkDiscountPriceEur
- DdPriceEur
- DdViapPriceEur
- DdSppdPriceEur
- DdDiscountPriceEur
- NkPriceEur
- NkViapPriceEur
- NkSppdPriceEur
- NkDiscountPriceEur
- MaPriceEur
- MaViapPriceEur
- VdPriceEur
- VdViapPriceEur
- SvPriceEur
- SvViapPriceEur
- MiPriceEur
- MiViapPriceEur
- RvPriceEur
- RgPriceEur
- VgPriceEur
- Reliability1PriceEur
- Reliability2PriceEur
- Reliability3PriceEur
- TechnologicalCostsViapPriceEur
- TechnologicalCostsPriceEur
- GeneralInterestPriceEur
- VkPayingRecoveredEnergyPriceEur
- DdPayingRecoveredEnergyPriceEur

- NkPayingRecoveredEnergyPriceEur
- MaPayingRecoveredEnergyPriceEur
- VdPayingRecoveredEnergyPriceEur
- SvPayingRecoveredEnergyPriceEur
- MiPayingRecoveredEnergyPriceEur
- VkPayingRecoveredMixedPriceEur
- DdPayingRecoveredMixedPriceEur
- NkPayingRecoveredMixedPriceEur
- MaPayingRecoveredMixedPriceEur
- VdPayingRecoveredMixedPriceEur
- SvPayingRecoveredMixedPriceEur
- MiPayingRecoveredMixedPriceEur
- VkMissingEnergyPriceEur
- VkMissingEnergyViapPriceEur
- VkMissingEnergySppdPriceEur
- DdMissingEnergyPriceEur
- DdMissingEnergyViapPriceEur
- DdMissingEnergySppdPriceEur
- NkMissingEnergyPriceEur
- NkMissingEnergyViapPriceEur
- NkMissingEnergySppdPriceEur
- MaMissingEnergyPriceEur
- MaMissingEnergyViapPriceEur
- VdMissingEnergyPriceEur
- VdMissingEnergyViapPriceEur
- SvMissingEnergyPriceEur
- SvMissingEnergyViapPriceEur
- MiMissingEnergyPriceEur
- MiMissingEnergyViapPriceEur
- VkMissingEnergyDiscountPriceEur
- DdMissingEnergyDiscountPriceEur
- NkMissingEnergyDiscountPriceEur
- PowerPlantCapacityPriceEur
- GaDiscount
- VkDiscount
- VkViapDiscount
- VkSppdDiscount
- VkDiscountDiscount
- DdDiscount
- DdViapDiscount
- DdSppdDiscount

- DdDiscountDiscount
- NkDiscount
- NkViapDiscount
- NkSppdDiscount
- NkDiscountDiscount
- MaDiscount
- MaViapDiscount
- VdDiscount
- VdViapDiscount
- SvDiscount
- SvViapDiscount
- MiDiscount
- MiViapDiscount
- RvDiscount
- RgDiscount
- VgDiscount
- Reliability1Discount
- Reliability2Discount
- Reliability3Discount
- TechnologicalCostsViapDiscount
- TechnologicalCostsDiscount
- GeneralInterestDiscount
- VkPayingRecoveredEnergyDiscount
- VkPayingRecoveredMixedDiscount
- VkMissingEnergyDiscount
- VkMissingEnergyViapDiscount
- VkMissingEnergySppdDiscount
- VkMissingEnergyDiscountDiscount
- GaAmountNoVAT
- VkAmountNoVAT
- VkViapAmountNoVAT
- VkSppdAmountNoVAT
- VkDiscountAmountNoVAT
- DdAmountNoVAT
- DdViapAmountNoVAT
- DdSppdAmountNoVAT
- DdDiscountAmountNoVAT
- NkAmountNoVAT
- NkViapAmountNoVAT
- NkSppdAmountNoVAT
- NkDiscountAmountNoVAT

- MaAmountNoVAT
- MaViapAmountNoVAT
- VdAmountNoVAT
- VdViapAmountNoVAT
- SvAmountNoVAT
- SvViapAmountNoVAT
- MiAmountNoVAT
- MiViapAmountNoVAT
- RvAmountNoVAT
- RgAmountNoVAT
- VgAmountNoVAT
- Reliability1AmountNoVAT
- Reliability2AmountNoVAT
- Reliability3AmountNoVAT
- TechnologicalCostsViapAmountNoVAT
- TechnologicalCostsAmountNoVAT
- GeneralInterestAmountNoVAT
- VkPayingRecoveredEnergyAmountNoVAT
- DdPayingRecoveredEnergyAmountNoVAT
- NkPayingRecoveredEnergyAmountNoVAT
- MaPayingRecoveredEnergyAmountNoVAT
- VdPayingRecoveredEnergyAmountNoVAT
- SvPayingRecoveredEnergyAmountNoVAT
- MiPayingRecoveredEnergyAmountNoVAT
- VkPayingRecoveredMixedAmountNoVAT
- DdPayingRecoveredMixedAmountNoVAT
- NkPayingRecoveredMixedAmountNoVAT
- MaPayingRecoveredMixedAmountNoVAT
- VdPayingRecoveredMixedAmountNoVAT
- SvPayingRecoveredMixedAmountNoVAT
- MiPayingRecoveredMixedAmountNoVAT
- VkMissingEnergyAmountNoVAT
- VkMissingEnergyViapAmountNoVAT
- VkMissingEnergySppdAmountNoVAT
- DdMissingEnergyAmountNoVAT
- DdMissingEnergyViapAmountNoVAT
- DdMissingEnergySppdAmountNoVAT
- NkMissingEnergyAmountNoVAT
- NkMissingEnergyViapAmountNoVAT
- NkMissingEnergySppdAmountNoVAT
- MaMissingEnergyAmountNoVAT

		<ul style="list-style-type: none"> <li>• MaMissingEnergyViapAmountNoVAT</li> <li>• VdMissingEnergyAmountNoVAT</li> <li>• VdMissingEnergyViapAmountNoVAT</li> <li>• SvMissingEnergyAmountNoVAT</li> <li>• SvMissingEnergyViapAmountNoVAT</li> <li>• MiMissingEnergyAmountNoVAT</li> <li>• MiMissingEnergyViapAmountNoVAT</li> <li>• VkMissingEnergyDiscountAmountNoVAT</li> <li>• DdMissingEnergyDiscountAmountNoVAT</li> <li>• NkMissingEnergyDiscountAmountNoVAT</li> <li>• PowerPlantCapacityAmountNoVAT</li> <li>• PermanentHomePlusAmountNoVAT</li> <li>• PermanentHomeAmountNoVAT</li> </ul>
0.6.26	2021-04-30	<p>Added error message text and 111 error code.</p> <ul style="list-style-type: none"> <li>• POST /supplier/v2/supplier-change-notifications (new)</li> </ul> <p>Added the rule 3 description and the new message ( Code 10).</p> <ul style="list-style-type: none"> <li>• POST /data/data-orders</li> </ul>
<del>0.6.27</del>	<del>2021-05-07</del>	<p><del>(will be deployed in next sprint) Added new json fields "clientName", "contractType", "currentSupplierType" and json field "contractType" rename to "contractModel", change "contractModel" possible values in:</del></p> <ul style="list-style-type: none"> <li><del>▪ POST /supplier/client/client-objects-information (new)</del></li> </ul>
0.6.28	2021-05-13	<p>Updated 9 error and 11 rule.</p> <ul style="list-style-type: none"> <li>▪ POST /gateway/supplier/send-declaration-data</li> </ul>
0.6.29	2021-06-03	<p>Updated 1 rule in:</p> <ul style="list-style-type: none"> <li>▪ POST /supplier/cancel-supplier-change-notification</li> </ul>
0.6.30	2021-06-07	Added contract data controller.
0.6.31	2021-06-08	Added new error message and rule description (4).



		<ul style="list-style-type: none"> <li>• POST /data/data-orders</li> </ul>
0.6.32	2021-06-09	<p>Edited 108 error message.</p> <ul style="list-style-type: none"> <li>• POST /supplier/v2/supplier-change-notifications (new)</li> </ul>
0.6.33	2021-06-11	<p>The rule 55 was added.</p> <ul style="list-style-type: none"> <li>• POST /contract-data/{changeType}/contract-change-notification</li> </ul>
0.6.34	2021-06-16	<p>Updated JSON specification of POST /reports/accounting-data-pack-b2c method and /reports/accounting-data-pack-b2b-meters-level method. Added new fields:</p> <ul style="list-style-type: none"> <li>▪ GeneratingCustomer</li> </ul>
0.6.35	2021-06-17	<p>Edited rule 2 description and error message 5;</p> <ul style="list-style-type: none"> <li>- POST /data/data-orders</li> </ul>
<del>0.6.36</del>	<del>2021-06-22</del>	<p><del>The new JSON field (contractType) and rule description were added;</del></p> <ul style="list-style-type: none"> <li><del>• POST /reports/objects-data-pack?first={integer}&amp;count={integer}</del></li> </ul>
0.6.37	2021-06-22	<p>Updated method (from GET to POST):</p> <ul style="list-style-type: none"> <li>• POST /gateway/contract-data/{changeType}/objects-list?first={integer}&amp;count={integer}&amp;sort={ASC/DSC}</li> <li>• POST /contract-data/contract-change-notification-details?first={integer}&amp;count={integer}&amp;sort={ASC/DSC}</li> </ul>
0.6.38	2021-07-08	<p>Updated method <b>URI</b> name:</p> <ul style="list-style-type: none"> <li>▪ POST /gateway/contract-data/{changeType}/objects-list?first={integer}&amp;count={integer}&amp;sortKey={string}&amp;sortOrder={ASC/DSC}</li> <li>▪ POST /gateway/contract-data/contract-change-notification-details?first={integer}&amp;count={integer}&amp;sortOrder={ASC/DSC}</li> <li>▪ POST /gateway/contract-data/{changeType}/contract-change-notification</li> <li>▪ POST /gateway/contract-data/cancel-contract-change-notification/{notificationId}</li> </ul> <p>Updated method 'POST /gateway/contract-data/{changeType}/contract-change-notification' error and rules numbering.</p> <p>Inserted HTTP status code '204' in method:</p> <ul style="list-style-type: none"> <li>• POST /gateway/contract-data/{changeType}/objects-list?first={integer}&amp;count={integer}&amp;sortKey={string}&amp;sortOrder={ASC/DSC}</li> </ul>

		<ul style="list-style-type: none"> <li>• POST /gateway/contract-data/contract-change-notification-details?first={integer}&amp;count={integer}&amp;sortOrder={ASC/DSC}</li> <li>• POST /gateway/contract-data/cancel-contract-change-notification/{notificationId}</li> </ul>
0.6.39	2021-07-13	<p>Updated json structure:</p> <ul style="list-style-type: none"> <li>• POST /gateway/contract-data/contract-change-notification-details?first={integer}&amp;count={integer}&amp;sortOrder={ASC/DSC}</li> <li>• POST /gateway/contract-data/{changeType}/contract-change-notification</li> </ul>
0.6.40	2021-07-14	Added contract termination notification controller.
0.6.41	2021-07-16	<p>Updated oldContractInfo segment json in:</p> <ul style="list-style-type: none"> <li>• POST /gateway/contract-data/contract-change-notification-details?first={integer}&amp;count={integer}&amp;sortOrder={ASC/DSC}</li> </ul>
0.6.42	2021-08-03	<p>Updated correspondenceAddress segment json in:</p> <ul style="list-style-type: none"> <li>• POST /gateway/contract-data/contract-change-notification-details?first={integer}&amp;count={integer}&amp;sortOrder={ASC/DSC}</li> </ul>
0.6.43	2021-08-04	Added an additional status „I - Sent“ of contract data controller.
0.6.44	2021-08-05	<p>Added the new methods for the reports' orders.</p> <ul style="list-style-type: none"> <li>• Metodas reports-orders-list <ul style="list-style-type: none"> <li>◦ POST/gateway/report-order-data/{supplierCode}/reports-orders-list?first={integer}&amp;count={integer}&amp;sortKey={string}&amp;sortOrder={ASC/DSC}</li> </ul> </li> <li>• Metodas report-order-details <ul style="list-style-type: none"> <li>◦ GET/gateway/report-order-data/{supplierCode}/report-order-details/{orderId}</li> </ul> </li> <li>• Metodas order-hourly-report-data <ul style="list-style-type: none"> <li>◦ POST/gateway/report-order-data/{supplierCode}/{reportShortName}/order-hourly-report-data</li> </ul> </li> <li>• Metodas order-report-data <ul style="list-style-type: none"> <li>◦ POST/gateway/report-order-data/{supplierCode}/{reportShortName}/order-report-data</li> </ul> </li> <li>• Metodas ordered-report-hr <ul style="list-style-type: none"> <li>◦ GET/gateway/report-order-data/{supplierCode}/ordered-report-hr/{orderId}</li> </ul> </li> </ul> <p>Added the new methods for the reports' orders. Metodas ordered-report-obj</p> <ul style="list-style-type: none"> <li>• GET/gateway/report-order-data/{supplierCode}/ordered-report-obj/{orderId}</li> </ul> <p>Added the new methods for the reports' orders.</p> <ul style="list-style-type: none"> <li>• GET/gateway/report-order-data/{supplierCode}/ordered-report-b2c/{orderId}</li> <li>• Metodas ordered-report-b2b</li> <li>• GET/gateway/report-order-data/{supplierCode}/ordered-report-b2b/{orderId}</li> </ul>

		<p>Metodas ordered-report-b2bm</p> <ul style="list-style-type: none"> <li>• GET/gateway/report-order-data/{supplierCode}/ordered-report-b2bm/{orderId}</li> </ul>
0.6.45	2021-08-09	<p>Changed 12 and 17 error messages in method:</p> <ul style="list-style-type: none"> <li>• POST /gateway/contract-data/{changeType}/contract-change-notification</li> </ul>
0.6.46	2021-08-10	<p>ContractModel moved to object level in method:</p> <ul style="list-style-type: none"> <li>• POST /gateway/contract-data/{changeType}/contract-change-notification</li> </ul>
0.6.47	2021-08-11	<p>Changed 14 error message and added 36 error message in method:</p> <ul style="list-style-type: none"> <li>• POST /gateway/contract-data/{changeType}/contract-change-notification</li> </ul>
0.6.48	2021-08-12	<p>Added 37, 38, 39, 40 error messages and 50, 51, 52, 53 rules in method:</p> <ul style="list-style-type: none"> <li>• POST /gateway/contract-data/{changeType}/contract-change-notification</li> </ul>
0.6.49	2021-08-24	<p>Added 41, 42 error messages and modified 53, 6, 54, 56 rules in method:</p> <ul style="list-style-type: none"> <li>• POST /gateway/contract-data/{changeType}/contract-change-notification</li> </ul> <p>Changed 33 error message code into 1003 in method:</p> <ul style="list-style-type: none"> <li>• POST /gateway/contract-data/{changeType}/contract-change-notification</li> </ul> <p>Added json field ,payoffMethod' in method:</p> <ul style="list-style-type: none"> <li>• POST /gateway/contract-data/{changeType}/objects-list?first={integer}&amp;count={integer}&amp;sortKey={string}&amp;sortOrder={ASC/DSC}</li> </ul> <p>Added json field ,payoffMethod' in ,oldContractInfo.object' group, in method:</p> <ul style="list-style-type: none"> <li>• POST /gateway/contract-data/contract-change-notification-details?first={integer}&amp;count={integer}&amp;sortOrder={ASC/DSC}</li> </ul> <p>Added 14 error message and rule description</p> <ul style="list-style-type: none"> <li>• POST /gateway/supplier/send-declaration-data</li> </ul> <p>Changed 1, 2 error codes into 1001 and 1002 in:</p> <ul style="list-style-type: none"> <li>• contract data controller</li> <li>• contract data controller - termination data</li> </ul> <p>Removed 4 error from:</p> <ul style="list-style-type: none"> <li>• POST /gateway/contract-data/{changeType}/objects-list?first={integer}&amp;count={integer}&amp;sortKey={string}&amp;sortOrder={ASC/DSC}</li> </ul>
0.6.50	2021-08-30	<p>Removed the field ,ownershipDocumentDate' in method:</p> <ul style="list-style-type: none"> <li>• POST /gateway/contract-data/contract-change-notification-details?first={integer}&amp;count={integer}&amp;sortOrder={ASC/DSC}</li> </ul>
0.6.51	2021-08-31	<p>Modified 23 rule and 41 error message in method:</p> <ul style="list-style-type: none"> <li>• POST /gateway/contract-data/{changeType}/contract-change-notification</li> </ul> <p>Added 54 rule and 43 error message in method:</p> <ul style="list-style-type: none"> <li>• POST /gateway/contract-data/{changeType}/contract-change-notification</li> </ul>
0.6.52	2021-09-03	<p>Added 58, 59, 60 rules and 44, 45, 46 error messages in method:</p> <ul style="list-style-type: none"> <li>• POST /gateway/contract-data/{changeType}/contract-change-notification</li> </ul>
0.6.53	2021-09-10	<p>Added the GET method of the 2SS report:</p> <ul style="list-style-type: none"> <li>• GET/gateway/report-order-data/ordered-report-data-2ss/{orderId}</li> </ul>
0.6.54	2021-09-23	<p>Added the description of the 9 error message:</p> <ul style="list-style-type: none"> <li>• POST /gateway/supplier/send-declaration-data</li> </ul>

0.6.55	2021-09-27	Added json field objectDataConsentSign and 3, 4, 5 rules in method: <ul style="list-style-type: none"> <li>• POST /gateway/contract-data/{changeType}/objects-list?first={integer}&amp;count={integer}&amp;sortKey={string}&amp;sortOrder={ASC/DSC}</li> </ul> Modified 28, 31 rules and added 61, 62 rules and 48, 49 errors in method: <ul style="list-style-type: none"> <li>• POST /gateway/contract-data/{changeType}/contract-change-notification</li> </ul>
0.6.56	2021-09-28	Added rule description 5: <ul style="list-style-type: none"> <li>• GET/gateway/report-order-data/ordered-report-data-hr/{orderId}</li> </ul>
0.6.57	2021-10-04	Value of json field „status“ was modified from „PR – Approved“ into „IV – Completed“ in controller: <ul style="list-style-type: none"> <li>• Contract data controller</li> <li>• Contract data controller – termination data</li> </ul>
0.6.58	2021-10-06	Added 19 rule and 120 error in method: <ul style="list-style-type: none"> <li>• POST /gateway/contract-data/termination-data/contract-termination-notification</li> </ul>
0.6.59	2021-10-12	Removed 5 rule in method: <ul style="list-style-type: none"> <li>• POST /gateway/contract-data/{changeType}/objects-list?first={integer}&amp;count={integer}&amp;sortKey={string}&amp;sortOrder={ASC/DSC}</li> </ul>
0.6.60	2021-10-13	Removed “JSON request”: dateFrom, dateTo. Added “JSON request”: contractSartFrom, contractStartTo, submittedDateFrom, submittedDateTo, in method: <ul style="list-style-type: none"> <li>• POST /gateway/contract-data/contract-change-notification-details?first={integer}&amp;count={integer}&amp;sortOrder={ASC/DSC}</li> </ul> Removed “JSON request”: dateFrom, dateTo. Added “JSON request”: contractTerminationDateFrom, contractTerminationDateTo, submittedDateFrom, submittedDateTo, in method: <ul style="list-style-type: none"> <li>• POST /gateway/contract-data/termination-data/contract-termination-notification-details?first={integer}&amp;count={integer}&amp;sortOrder={ASC/DSC}</li> </ul>
0.6.61	2021-10-15	Added the new supplier change notification v2 controller: -POST method: <ul style="list-style-type: none"> <li>• <del>POST /gateway/supplier-change-notification/v2/objects-list?first={integer}&amp;count={integer}&amp;sortKey={string}&amp;sortOrder={ASC/DSC}</del></li> </ul>
0.6.62	2021-10-19	Added the POST methods of supplier change notification v2 controller: <ul style="list-style-type: none"> <li>• <del>POST /gateway/supplier-change-notification/v2/list?first={integer}&amp;count={integer}&amp;sortKey={string}&amp;sortOrder={ASC/DSC}</del></li> <li>• <del>POST /gateway/supplier-change-notification/v2</del></li> <li>• <del>POST /gateway/supplier-change-notification/v2/{notificationId}/cancel</del></li> </ul>
0.6.63	2021-10-17	Added new fields noCoowner, ntGetCoownerConsent, coownerConsentDate in method: <ul style="list-style-type: none"> <li>• POST /gateway/contract-data/termination-data/contract-termination-notification-details?first={integer}&amp;count={integer}&amp;sortOrder={ASC/DSC}</li> </ul>

0.6.64	2021-10-28	<p>Added submittedDateFrom/To attribute to the JSON request:</p> <ul style="list-style-type: none"> <li>• POST/gateway/report-order-data/reports-orders-list?first={integer}&amp;count={integer}&amp;sortKey={string}&amp;sortOrder={ASC/DSC}</li> </ul> <p>Removed the error message (error code 9) from the new methods of the reports. Changed searchParameter to orderParameter. Changed auto_order to auto.</p> <p>Edited the attributes of the JSON request:</p> <ul style="list-style-type: none"> <li>• POST/gateway/report-order-data/{reportShortName}/order-report-data.</li> </ul>
0.6.65	2021-10-29	<p>Removed "JSON request": objectNumbers. Added "JSON request": objects, objectNumber, noCoowner, ntGetCoownerConsent, coownerConsentDate AND added new error messages (no. 20 – 26) in method:</p> <ul style="list-style-type: none"> <li>• POST /gateway/contract-data/termination-data/contract-termination-notification</li> </ul>
0.6.66	2021-11-03	<p>Edited <b>the structure of the JSON:</b></p> <ul style="list-style-type: none"> <li>• GET/gateway/report-order-data/ordered-report-data-2ss/{orderId}</li> </ul>
0.6.67	2021-11-05	<p>Added JSON attribute „userName“:</p> <ul style="list-style-type: none"> <li>• <del>POST /gateway/supplier-change-data/supplier-change-notification-list?first={integer}&amp;count={integer}&amp;sortKey={string}&amp;sortOrder={ASC/DSC}</del></li> <li>• POST /gateway/contract-data/termination-data/contract-termination-notification-details?first={integer}&amp;count={integer}&amp;sortOrder={ASC/DSC}</li> <li>• POST /gateway/contract-data/contract-change-notification-details?first={integer}&amp;count={integer}&amp;sortOrder={ASC/DSC}</li> </ul> <p>Added JSON parameters „userNameSearch“:</p> <ul style="list-style-type: none"> <li>• <del>POST /gateway/supplier-change-data/supplier-change-notification-list?first={integer}&amp;count={integer}&amp;sortKey={string}&amp;sortOrder={ASC/DSC}</del></li> <li>• POST /gateway/contract-data/termination-data/contract-termination-notification-details?first={integer}&amp;count={integer}&amp;sortOrder={ASC/DSC}</li> <li>• POST /gateway/contract-data/contract-change-notification-details?first={integer}&amp;count={integer}&amp;sortOrder={ASC/DSC}</li> </ul>
0.6.68	2021-11-08	<p>Added 63 rule and 51 error in method:</p> <ul style="list-style-type: none"> <li>• POST /gateway/contract-data/{changeType}/contract-change-notification</li> </ul>
0.6.69	2021-11-11	<p>Changed URL (Contract termination notification controller):</p> <ul style="list-style-type: none"> <li>• POST /gateway/contract-termination-notification/object-list?first={integer}&amp;count={integer}&amp;sortKey={string}&amp;sortOrder={ASC/DSC}</li> <li>• POST /gateway/contract-termination-notification/details?first={integer}&amp;count={integer}&amp;sortOrder={ASC/DSC}</li> <li>• POST /gateway/contract-termination-notification</li> </ul>

		<ul style="list-style-type: none"> <li>• POST /gateway/contract-termination-notification/{notificationId}/cancel</li> </ul>
0.6.70	2021-11-11	Name of Contract data controller was changed into Contract change notification controller.
0.6.71	2021-11-11	<p>Changed URL (Supplier change notification controller):</p> <ul style="list-style-type: none"> <li>• <del>POST /gateway/supplier-change-notification/v2/object-list?first={integer}&amp;count={integer}&amp;sortKey={string}&amp;sortOrder={ASC/DSC}</del></li> <li>• <del>POST /gateway/supplier-change-notification/v2/list?first={integer}&amp;count={integer}&amp;sortKey={string}&amp;sortOrder={ASC/DSC}</del></li> <li>• <del>POST /gateway/supplier-change-notification/v2</del></li> <li>• <del>POST /gateway/supplier-change-notification/v2/{notificationId}/cancel</del></li> </ul>
0.6.72	2021-11-12	<p>Changed URL (Order controller):</p> <ul style="list-style-type: none"> <li>• POST/gateway/order/list?first={integer}&amp;count={integer}&amp;sortKey={string}&amp;sortOrder={ASC/DSC}</li> <li>• GET/gateway/order/{orderId}/details</li> <li>• POST/gateway/order/{orderShortName}/hourly</li> <li>• POST/gateway/order/{orderShortName}</li> <li>• GET/gateway/order/{orderId}/hr</li> <li>• GET/gateway/order/{orderId}/2ss</li> </ul>
		<p>Changed URL (Order controller):</p> <ul style="list-style-type: none"> <li>• GET/gateway/order/{orderId}/obj</li> </ul>
		<p>Changed URL (Order controller):</p> <ul style="list-style-type: none"> <li>• GET/gateway/order/{orderId}/b2c</li> <li>• GET/gateway/order/{orderId}/b2b</li> </ul>
0.6.73	2021-11-15	<p>Error message was deleted:</p> <ul style="list-style-type: none"> <li>• POST/gateway/order/{orderShortName}</li> </ul>
		<p>Changed the JSON structure, added new attribute:</p> <ul style="list-style-type: none"> <li>• GET/gateway/order/{orderId}/obj</li> </ul>

0.6.74	2021-11-15	<p>Added the new error message 1004:</p> <ul style="list-style-type: none"> <li>• POST /reports/accounting-data-pack-b2c?first={integer}&amp;count={integer}</li> <li>• POST /reports/accounting-data-pack-b2b?first={integer}&amp;count={integer}</li> <li>• POST /reports/accounting-data-pack-b2b-meters-level?first={integer}&amp;count={integer}</li> <li>• POST /reports/objects-data-pack?first={integer}&amp;count={integer}</li> </ul>
0.6.75	2021-11-15	<p>Changed 46, 15, 16 rules and deleted 36 error in method:</p> <ul style="list-style-type: none"> <li>• POST /gateway/contract-data/{changeType}/contract-change-notification</li> </ul>
0.6.76	2021-11-17	<p>JSON attributes were changed:</p> <ul style="list-style-type: none"> <li>• POST/gateway/order/{orderShortName}</li> </ul>
		<p>JSON attributes were changed:</p> <ul style="list-style-type: none"> <li>• GET/gateway/order/{orderId}/obj</li> </ul>
0.6.77	2021-11-18	<p>(Order controller) B2B order was deleted. B2Bm was renamed to B2B. Added the new error message and deleted the attribute "statusDate"</p> <ul style="list-style-type: none"> <li>• POST/gateway/order/list?first={integer}&amp;count={integer}&amp;sortKey={string}&amp;sortOrder={ASC/DSC}</li> <li>• Order controller codes of the error messages were changed.</li> </ul>
0.6.78	2021-11-19	<p>Changed 17 error message in method:</p> <ul style="list-style-type: none"> <li>• POST /gateway/contract-data/{changeType}/contract-change-notification</li> </ul>
0.6.79	2021-11-24	<p>JSON request attributes were deleted:</p> <ul style="list-style-type: none"> <li>• POST/gateway/order/{orderShortName}</li> </ul> <p>Added the new error message:</p> <ul style="list-style-type: none"> <li>• POST/gateway/order/{orderShortName}/hourly</li> </ul>
0.6.80	2021-12-03	<p>Changed data type of the attributes (submittedDateFrom, submittedDateTo, dateFrom, dateTo)</p> <ul style="list-style-type: none"> <li>• POST/gateway/order/list?first={integer}&amp;count={integer}&amp;sortKey={string}&amp;sortOrder={ASC/DSC}</li> <li>• POST/gateway/order/{orderShortName}</li> </ul> <p>Deleted error message 2003:</p> <ul style="list-style-type: none"> <li>• POST/gateway/order/list?first={integer}&amp;count={integer}&amp;sortKey={string}&amp;sortOrder={ASC/DSC}</li> </ul> <p>Edited error message 2003:</p> <ul style="list-style-type: none"> <li>• POST/gateway/order/{orderShortName}</li> <li>• POST/gateway/order/{orderShortName}/hr</li> </ul>

0.6.81	2021-12-06	Deleted 2006 error message, changed 2001 error message <ul style="list-style-type: none"> <li>• POST/gateway/order/{orderShortName}</li> </ul>
0.6.82		Added the new error message 2015 <ul style="list-style-type: none"> <li>• POST/gateway/order/{orderShortName}</li> <li>• POST/gateway/order/{orderShortName}/hr</li> </ul>
0.6.83	2021-12-09	Changed JSON request structure, deleted 2001 error message and edited 2007 error message: <ul style="list-style-type: none"> <li>• POST/gateway/order/{orderShortName}/hr</li> </ul>
0.6.84	2021-12-10	Added the error messages and rule description 112,113: <ul style="list-style-type: none"> <li>• <del>POST /gateway/supplier-change-notification/v2</del></li> <li>• POST /supplier/v2/supplier-change-notifications</li> </ul>
0.6.85	2021-12-13	Added new controller: "Contract object". <ul style="list-style-type: none"> <li>• Added new method: POST /gateway/contract-object/list?first={integer}&amp;count={integer}&amp;sortKey={string}&amp;sortOrder={ASC/DSC} The method is designed to obtain a list of valid objects in the contract according to the selection criteria.</li> <li>• Removed method: POST /gateway/contract-termination-notification/object-list?first={integer}&amp;count={integer}&amp;sortKey={string}&amp;sortOrder={ASC/DSC}</li> </ul>
0.6.86	2021-12-14	Added the new controller and methods: <ul style="list-style-type: none"> <li>• The new controller – Tariff plan change notification controller</li> <li>• POST /gateway/tariff-plan-change-notification/list??first={integer}&amp;count={integer}&amp;sortKey={string}&amp;sortOrder={ASC/DSC}</li> <li>• POST /gateway/tariff-plan-change-notification</li> <li>• POST /gateway/tariff-plan-change-notification/{notificationId}/cancel</li> </ul>
0.6.87	2021-12-16	Removed 25 and 26 error in method: <ul style="list-style-type: none"> <li>• POST /gateway/contract-data/{changeType}/contract-change-notification</li> </ul>
0.6.88	2021-12-21	Added the contract list controller: <ul style="list-style-type: none"> <li>• POST/gateway/contract/list?first={integer}&amp;count={integer}&amp;sortKey={string}&amp;sortOrder={ASC/DSC}</li> </ul>
0.6.89	2021-12-22	Added the new controller – Contact change notification controller: <ul style="list-style-type: none"> <li>• POST /gateway/contact-change-notification/list??first={integer}&amp;count={integer}&amp;sortKey={string}&amp;sortOrder={ASC/DSC}</li> <li>• POST /gateway/contact-change-notification</li> <li>• POST /gateway/contact-change-notification/{notificationId}/cancel</li> </ul>
0.6.90	2021-12-22	Edited the 112 and 103 error messages. Added the new error 116 <ul style="list-style-type: none"> <li>• <del>POST /gateway/supplier-change-notification/v2</del></li> <li>• POST /supplier/v2/supplier-change-notifications (new)</li> </ul>



0.6.91	2021-12-23	<p>Added new json field `mobPhoneNoObject` in method:</p> <ul style="list-style-type: none"> <li>• <del>POST /gateway/contract-object/list?first={integer}&amp;count={integer}&amp;sortKey={string}&amp;sortOrder={ASC/DSC}</del></li> <li>• POST /gateway/object/my/active/list?first={integer}&amp;count={integer}&amp;sortKey={string}&amp;sortOrder={ASC/DSC}</li> </ul>
0.6.92	2021-12-23	<p>Edited JSON structure:</p> <ul style="list-style-type: none"> <li>• GET/gateway/order/{orderId}/2ss</li> </ul>
		<p>Changed attribute name:</p> <ul style="list-style-type: none"> <li>• GET/gateway/order/{orderId}/obj</li> </ul>
0.6.93	2021-12-30	<p>Added new 117 error in method:</p> <ul style="list-style-type: none"> <li>• POST /supplier/v2/supplier-change-notifications (new)</li> </ul>
0.6.94	2022-01-04	<p>Changed GET url:</p> <ul style="list-style-type: none"> <li>• GET/gateway/order/{orderId}/2s2s</li> </ul> <p>Changed orderShortName and orderName from 2ss to 2s2s:</p> <ul style="list-style-type: none"> <li>• POST/gateway/order/list?first={integer}&amp;count={integer}&amp;sortKey={string}&amp;sortOrder={ASC/DSC}</li> <li>• POST/gateway/order/{orderShortName}</li> </ul> <p>Changed username attribute to usreName:</p> <ul style="list-style-type: none"> <li>• POST/gateway/order/list?first={integer}&amp;count={integer}&amp;sortKey={string}&amp;sortOrder={ASC/DSC}</li> </ul>
0.6.95	2022-01-06	<p>Deleted POST and GET methods:</p> <ul style="list-style-type: none"> <li>• POST/gateway/order/{orderShortName}/hr</li> <li>• GET/gateway/order/{orderId}/hr</li> </ul> <p>Added new methods:</p> <ul style="list-style-type: none"> <li>• POST/gateway/order/hr-object</li> <li>• POST/gateway/order/hr-meter</li> <li>• GET/gateway/order/{orderId}/hr-object</li> <li>• GET/gateway/order/{orderId}/hr-meter</li> <li>• GET/gateway/order/{orderId}/hr-object/count</li> <li>• GET/gateway/order/{orderId}/hr-meter/count</li> </ul>
0.6.96	2022-01-11	<p>Changed the structure of the JSON Response</p> <ul style="list-style-type: none"> <li>• GET/gateway/order/{orderId}/2s2s</li> </ul>
0.9.97	2022-01-13	<p>Added new 127 error and 26 rule in method:</p> <ul style="list-style-type: none"> <li>• POST /gateway/contract-termination-notification</li> </ul>

0.9.98	2022-01-13	<p>Removed “ntGetCoownerConsent”, renamed “noCoowner” into “coowner” in methods:</p> <ul style="list-style-type: none"> <li>• POST /gateway/contract-termination-notification/details?first={integer}&amp;count={integer}&amp;sortOrder={ASC/DSC}</li> <li>• POST /gateway/contract-termination-notification</li> </ul> <p>Edited 121, 122 error, removed 124, 125 error, added 128 error in method:</p> <ul style="list-style-type: none"> <li>• POST /gateway/contract-termination-notification</li> </ul>
0.9.99	2022-01-14	<p>Deleted the methods:</p> <ul style="list-style-type: none"> <li>• POST/gateway/order/hr-object</li> <li>• POST/gateway/order/hr-meter</li> <li>• GET/gateway/order/{orderId}/hr-object/count</li> <li>• GET/gateway/order/{orderId}/hr-meter/count</li> </ul> <p>Added the method:</p> <ul style="list-style-type: none"> <li>• POST/gateway/order/{orderShortName}</li> <li>• GET/gateway/order/{orderId}/{orderShortName}/count</li> </ul> <p>Added the error message 2016 and 2017 for the GET methods.</p>
0.7.0	2022-01-17	<p>JSON attribute changed from consumerCode to personCode</p> <ul style="list-style-type: none"> <li>• GET/gateway/order/{orderId}/hr-object</li> <li>• GET/gateway/order/{orderId}/hr-meter</li> </ul> <p>Added new attribute objectBsId to JSON respons structure:</p> <ul style="list-style-type: none"> <li>• GET/gateway/order/{orderId}/hr-object</li> <li>• GET/gateway/order/{orderId}/hr-meter</li> </ul> <p>Added new attribute objectBsId to JSON respons structure:</p> <ul style="list-style-type: none"> <li>• GET/gateway/order/{orderId}/2s2s</li> </ul> <p>Added new attribute objectBsId to JSON respons structure:</p> <ul style="list-style-type: none"> <li>• GET/gateway/order/{orderId}/obj</li> </ul>
0.7.1	2022-01-24	<ul style="list-style-type: none"> <li>• “Contract object controller” renamed into “Object controller”</li> <li>• Url “POST /gateway/contract-object/list?first={integer}&amp;count={integer}&amp;sortKey={string}&amp;sortOrder={ASC/DSC}” renamed into “POST /gateway/object/my/active/list?first={integer}&amp;count={integer}&amp;sortKey={string}&amp;sortOrder={ASC/DSC}”</li> <li>• Added new field “supplyOwnership” in method: “POST /gateway/object/my/active/list?first={integer}&amp;count={integer}&amp;sortKey={string}&amp;sortOrder={ASC/DSC}”</li> <li>• A new method “POST /gateway/object/all/active/list?first={integer}&amp;count={integer}&amp;sortKey={string}&amp;sortOrder={ASC/DSC}” has been created for the method “POST /gateway/contract-data/{changeType}/objects-list?first={integer}&amp;count={integer}&amp;sortKey={string}&amp;sortOrder={ASC/DSC}”.</li> </ul>

		<p>Changes are highlighted in green in method:  “POST /gateway/object/all/active/list?first={integer}&amp;count={integer}&amp;sortKey={string}&amp;sortOrder={ASC/DSC}”</p> <ul style="list-style-type: none"> <li>• A method: “POST /gateway/contract-data/{changeType}/objects-list?first={integer}&amp;count={integer}&amp;sortKey={string}&amp;sortOrder={ASC/DSC}” will be eliminated.</li> <li>• Removed 40 error in method:  POST /gateway/contract-data/{changeType}/contract-change-notification</li> </ul>
0.7.2	2022-01-24	<p>Added the new method in the Order controller:</p> <ul style="list-style-type: none"> <li>• GET/gateway/order/list/count</li> </ul> <p>Changed parameter name from orderShortName to hrOrderShortName:</p> <ul style="list-style-type: none"> <li>• POST/gateway/order/{hrOrderShortName}</li> </ul>
0.7.3	2022-01-24	<p>“Tariff plan change notification controller” renamed into “Notification contract tariff plan controller”.  Changed URL in the “Notification contract tariff plan controller”:</p> <ul style="list-style-type: none"> <li>• POST /gateway/notification/contract/tariff-plan/list?first={integer}&amp;count={integer}&amp;sortKey={string}&amp;sortOrder={ASC/DSC}</li> <li>• POST /gateway/notification/contract/tariff-plan</li> <li>• POST /gateway/notification/{notificationId}/contract/tariff-plan/cancel</li> </ul> <p>“Contract change notification controller” renamed into “Notification contract contact controller”.  Changed URL in the “Notification contract contact controller”:</p> <ul style="list-style-type: none"> <li>• POST  /gateway/notification/contract/contact/list?first={integer}&amp;count={integer}&amp;sortKey={string}&amp;sortOrder={ASC/DSC}</li> <li>• POST /gateway/notification/contract/contact</li> <li>• POST /gateway/notification/{notificationId}/contract/contact/cancel</li> </ul>
0.7.4	2022-01-24	<p>“Contract termination notification controller” renamed into “Notification contract termination controller”.  Changed URL in the “Notification contract termination controller”:</p> <ul style="list-style-type: none"> <li>• POST /gateway/notification/contract/termination/list?first={integer}&amp;count={integer}&amp;sortOrder={ASC/DSC}</li> <li>• POST /gateway/notification/contract/termination</li> <li>• POST /gateway/notification/{notificationId}/contract/termination/cancel</li> </ul>
0.7.5	2022-01-24	<p>Added new controller “Notification contract controller”.</p> <ul style="list-style-type: none"> <li>• Methods in this controller are very similar to method in controller „Contract change notification controller“. Differences are highlighted in green.</li> <li>• Note: The controller “Contract change notification controller” and its methods will be eliminated after “Notification contract controller” implementation date + 6 months.</li> </ul>

0.7.6	2022-01-27	<p>Changed 10, 11, 17 rules and 11 error in method:</p> <ul style="list-style-type: none"> <li>• POST /gateway/contract-data/{changeType}/contract-change-notification</li> </ul> <p>Note: In the new method “POST /gateway/notification/contract/owner”, these rules and error will also be implemented.</p>
0.7.7	2022-01-27	<p>Added new attribute (statusDate) in the method: POST/gateway/order/list?first={integer}&amp;count={integer}&amp;sortKey={string}&amp;sortOrder={ASC/DSC}</p>
0.7.8	2022-01-28	<p>Removed controller and its methods “Supplier change notification v2 controller”. It has not yet been implemented, only a change in the documentation.</p>
0.7.9	2022-01-31	<p>Added errorType in method: POST /gateway/notification/contract/list?first={integer}&amp;count={integer}&amp;sortOrder={ASC/DSC}</p>
0.7.10	2022-01-31	<p>Added errorType in method: POST /gateway/notification/contract/termination/list?first={integer}&amp;count={integer}&amp;sortOrder={ASC/DSC}</p>
0.7.11	2022-02-01	<p>Edited 71 error and 10 rule in method: POST /gateway/notification/contract/termination</p>
0.7.12	2022-02-03	<p>Added the new rule 2018:</p> <ul style="list-style-type: none"> <li>• GET/gateway/order/{orderId}/hr-object</li> <li>• GET/gateway/order/{orderId}/hr-meter</li> <li>• GET/gateway/order/{orderId}/2s2s</li> </ul> <p>Added the new rule 2018:</p> <ul style="list-style-type: none"> <li>• GET/gateway/order/{orderId}/obj</li> </ul> <p>Added the new rule 2018:</p> <ul style="list-style-type: none"> <li>• GET/gateway/order/{orderId}/b2c</li> <li>• GET/gateway/order/{orderId}/b2b</li> </ul>
0.7.13	2022-02-04	<p>Deleted the error message 2007:</p> <ul style="list-style-type: none"> <li>• POST/gateway/order/{hrOrderShortName};</li> <li>• POST/gateway/order/{orderShortName}</li> </ul>
0.7.14	2022-02-07	<p>Deleted satusDate attribute:</p> <ul style="list-style-type: none"> <li>• POST/gateway/order/list</li> </ul>
0.7.15	2022-02-11	<p>Edited 24 error in method:</p> <ul style="list-style-type: none"> <li>• POST /gateway/contract-data/{changeType}/contract-change-notification</li> </ul>

0.7.16	2022-02-17	Added the attribute statusDate in JSON response structure of the method: <ul style="list-style-type: none"> <li>• POST/gateway/order/list</li> </ul>
0.7.17	2022-02-21	Changed data type from timestamp to date and attributes names were changed: <ul style="list-style-type: none"> <li>• GET/gateway/order/{orderId}/obj</li> </ul>
		consumptionCategory changed from not required to required: <ul style="list-style-type: none"> <li>• POST/gateway/order/{hrOrderShortName}</li> </ul>
0.7.18	2022-02-22	Added "meterNumbers":[string] in method: <ul style="list-style-type: none"> <li>• POST /gateway/notification/contract/list?first={integer}&amp;count={integer}&amp;sortOrder={ASC/DSC}</li> </ul>
0.7.19	2022-02-22	Added method: <ul style="list-style-type: none"> <li>• POST/v2/data/data-orders</li> </ul> This method already exists, was lost in the documentation
0.7.20	2022-02-23	Added new error message 1004: <ul style="list-style-type: none"> <li>• POST/gateway/order/{hrOrderShortName}</li> <li>• POST/gateway/order/{orderShortName}</li> </ul>
		Changed JSON attributes names: personName; personSurnaem; objectId: <ul style="list-style-type: none"> <li>• GET/gateway/order/{orderId}/2s2s</li> <li>• GET/gateway/order/{orderId}/hr-object</li> <li>• GET/gateway/order/{orderId}/hr-meter</li> </ul>
		Changed JSON attributes names: personName; personSurnaem; objectId: <ul style="list-style-type: none"> <li>• GET/gateway/order/{orderId}/obj</li> </ul>
0.7.21	2022-02-28	Added the new rule 2019 in Order controller: <ul style="list-style-type: none"> <li>• POST/gateway/order/{orderShortName}</li> </ul>
0.7.22	2022-03-02	Changed JSON response structure, generatingObjectType moved to product level: <ul style="list-style-type: none"> <li>• GET/gateway/order/{orderId}/2s2s</li> </ul>
0.7.23	2022-03-03	Removed 39 error in method: <ul style="list-style-type: none"> <li>• POST /gateway/notification/contract/owner</li> <li>• POST /gateway/contract-data/{changeType}/contract-change-notification</li> </ul>
0.7.24	2022-03-07	Added json field PayoffMethod in method: <ul style="list-style-type: none"> <li>• POST /reports/objects-data-pack?first={integer}&amp;count={integer}</li> </ul>
0.7.25	2022-03-08	Added method: <ul style="list-style-type: none"> <li>• POST /gateway/declaration/reading/list</li> </ul>
0.7.26	2022-03-21	Deleted rule description. <ul style="list-style-type: none"> <li>• POST/gateway/order/{hrOrderShortName}</li> </ul>
0.7.27	2022-03-22	Added objectPowers in method:

		<ul style="list-style-type: none"> <li>• POST /gateway/object/all/active/list?first={integer}&amp;count={integer}&amp;sortKey={string}&amp;sortOrder={ASC/DSC}</li> </ul>
0.7.28	2022-03-25	<p>Changed the JSON response attribute name from the status to latestStatus:</p> <ul style="list-style-type: none"> <li>• POST/gateway/order/list</li> </ul>
0.7.29	2022-03-28	<p>Changed attribute name from orderShortName to orderType:</p> <ul style="list-style-type: none"> <li>• POST/gateway/order/list</li> <li>• POST/gateway/order/list/count</li> </ul>
0.7.30	2022-03-28	<p>Removed json tariffPlanCategory in method:</p> <ul style="list-style-type: none"> <li>• POST /gateway/object/my/active/list?first={integer}&amp;count={integer}&amp;sortKey={string}&amp;sortOrder={ASC/DSC}</li> </ul>
0.7.31	2022-03-31	<p>Edited json request attribute from objectNumber to objectNumbers</p> <ul style="list-style-type: none"> <li>• POST/order/{hrOrderShortName}</li> </ul>
0.7.32	2022-03-31	<p>Edited json request attribute from orderType to orderTypes</p> <ul style="list-style-type: none"> <li>• POST/gateway/order/list</li> </ul>
0.7.33	2022-04-01	<p>Edited json request attribute “status”, added json request attribute “changeType” in method:</p> <ul style="list-style-type: none"> <li>• POST /gateway/notification/contract/list?first={integer}&amp;count={integer}&amp;sortOrder={ASC/DSC}</li> </ul>
0.7.34	2022-04-04	<p>Changed HTTP status from 200 to 201 in method:</p> <ul style="list-style-type: none"> <li>• POST/gateway/order/{orderShortName}</li> <li>• POST/gateway/order/{hrOrderShortName}</li> </ul>
0.7.35	2022-04-05	<p>Added “6.1.3.4 Algorithm for using DELTA solution”. Method:</p> <ul style="list-style-type: none"> <li>• POST /gateway/declaration/reading/list</li> </ul>
0.7.36	2022-04-07	<p>Changed possible meanings “orderType”. Method:</p> <ul style="list-style-type: none"> <li>• POST/gateway/order/list?first={integer}&amp;count={integer}&amp;sortKey={string}&amp;sortOrder={ASC/DSC}</li> </ul> <p>Changed a parameter “hr15OrderShortName” and url. Method:</p> <ul style="list-style-type: none"> <li>• POST/gateway/order/{hr15OrderShortName}</li> </ul> <p>Changed a parameter “orderShortName”. Method:</p> <ul style="list-style-type: none"> <li>• POST/gateway/order/{orderShortName}</li> </ul> <p>Changed url from “GET/gateway/order/{orderId}/hr-object” to “GET/gateway/order/{orderId}/data-hr-15min-obj-lvl”.</p> <p>Changed url from “GET/gateway/order/{orderId}/hr-meter” to “GET/gateway/order/{orderId}/data-hr-15min-mtr-lvl”.</p> <p>Changed url from “GET/gateway/order/{orderId}/2s2s” to “GET/gateway/order/{orderId}/bill-2s2s-b2b”.</p> <p>Changed url from “GET/gateway/order/{orderId}/obj” to “GET/gateway/order/{orderId}/report-obj”.</p>

0.7.37	2022-04-07	Added a new json attribute "smartMeterInstallationDate": "date". Method: <ul style="list-style-type: none"> <li>• GET/gateway/order/{orderId}/report-obj</li> </ul>
0.7.38	2022-04-12	Added a new request parameter "interval". Method: <ul style="list-style-type: none"> <li>• POST/gateway/order/{hr15OrderShortName}</li> </ul>
0.7.39	2022-04-15	Implemented Order controller methods: <ul style="list-style-type: none"> <li>• POST/gateway/order/list?first={integer}&amp;count={integer}&amp;sortKey={string}&amp;sortOrder={ASC/DSC}</li> <li>• POST/gateway/order/{hr15OrderShortName}</li> <li>• POST/gateway/order/{orderShortName}</li> </ul> except: bill-bss-b2b - Billing report for BSS model B2B; bill-bss-b2c - Billing report for BSS model B2C; <ul style="list-style-type: none"> <li>• GET/gateway/order/{orderId}/data-hr-15min-obj-lvl</li> <li>• GET/gateway/order/{orderId}/data-hr-15min-mtr-lvl</li> <li>• GET/gateway/order/{orderId}/bill-2s2s-b2b</li> <li>• GET/gateway/order/{orderId}/report-obj</li> <li>• GET/gateway/order/{orderId}/count</li> </ul>
0.7.40	2022-04-22	Deleted methods: <ul style="list-style-type: none"> <li>• POST /data/data-orders</li> <li>• POST /reports/accounting-data-pack-b2b?first={integer}&amp;count={integer}</li> <li>• POST /reports/accounting-data-pack-b2b-count</li> </ul>
0.7.41	2022-04-22	Changed methods: <ul style="list-style-type: none"> <li>• POST /gateway/notification/contract/list?first={integer}&amp;count={integer}&amp;sortOrder={ASC/DSC}</li> <li>• POST /gateway/notification/contract</li> <li>• POST /gateway/notification/{notificationId}/contract/cancel</li> </ul> <p>These methods are adapted to the NTK (change of supplier) process. All changes in SK and STK processes, also new rules for NTK process are highlighted <a href="#">in blue</a>.</p>
0.7.42	2022-04-27	Edited 38, 52 rules and 42 error in method: <ul style="list-style-type: none"> <li>• POST /gateway/notification/contract</li> </ul>
0.7.43	2022-05-03	Edited 4 rule, 2003 error in the method: <ul style="list-style-type: none"> <li>• POST/gateway/order/{orderShortName}</li> </ul>
0.7.44	2022-05-03	Edited 6 rule, 12 error in the method: <ul style="list-style-type: none"> <li>• POST /gateway/declaration/reading/list</li> </ul>
0.7.45	2022-05-04	Edited 10 rule in the method: POST /gateway/supplier/send-declaration-data

0.7.46	2022-05-04	<ul style="list-style-type: none"> <li>Changed url from POST /gateway/declaration/reading/list to POST /gateway/declaration/reading/list?first={integer}&amp;count={integer}&amp;sortKey={string}&amp;sortOrder={ASC/DSC}</li> <li>Added sort and sortOrder parameters.</li> </ul>
0.7.47	2022-05-05	<p>Added 68 rule and 134 error in method:</p> <ul style="list-style-type: none"> <li>POST /gateway/notification/contract</li> </ul>
0.7.48	2022-05-05	<p>Edited count default value for these methods:</p> <ul style="list-style-type: none"> <li>GET/gateway/order/{orderId}/bill-2s2s-b2b</li> <li>GET/gateway/order/{orderId}/data-hr-15min-mtr-lvl</li> <li>GET/gateway/order/{orderId}/data-hr-15min-obj-lvl</li> <li>GET/gateway/order/{orderId}/report-obj</li> <li>POST/gateway/order/list?first={integer}&amp;count={integer}&amp;sortKey={string}&amp;sortOrder={ASC/DSC}</li> </ul>
0.7.49	2022-05-09	<p>Edited 26, 27 rules and 20, 21 errors in method:</p> <ul style="list-style-type: none"> <li>POST /gateway/notification/contract</li> </ul>
0.7.50	2022-06-06	<p>Added new 141, 147, 148 errors in the method:</p> <ul style="list-style-type: none"> <li>POST /gateway/notification/contract</li> </ul> <p>Added new fields representativeName, representativeSurname, representativeDuty in the method:</p> <ul style="list-style-type: none"> <li>POST /gateway/notification/contract/list?first={integer}&amp;count={integer}&amp;sortOrder={ASC/DSC}</li> </ul> <p>Changes are highlighted in <a href="#">blue</a></p>
0.7.51	2022-06-16	<p>Changed date format of consumptionTime in method:</p> <ul style="list-style-type: none"> <li>GET/gateway/order/{orderId}/data-hr-15min-mtr-lvl</li> <li>GET/gateway/order/{orderId}/data-hr-15min-obj-lvl</li> </ul> <p>Example of consumptionTime format: 2022-06-07T00:00:00+02:00 2022-06-07T00:00:00+03:00</p>
0.7.52	2022-06-22	<p>Added json response field "tariffPlan" in method: GET/gateway/order/{orderId}/bill-2s2s-b2b</p>
0.7.53	2022-06-28	<p>Removed method:</p> <ul style="list-style-type: none"> <li>GET /gateway/supplier/v2/get-declaration-data?first={integer}&amp;count={integer}&amp;customerId={string}&amp;objectNumber={string}</li> </ul>
0.7.54	2022-06-29	<p>Added 'objectFutureSupplier' in method:</p> <ul style="list-style-type: none"> <li>POST /gateway/object/all/active/list?first={integer}&amp;count={integer}&amp;sortKey={string}&amp;sortOrder={ASC/DSC}</li> </ul>
0.7.55	2022-06-29	<p>Added new controller "Notification contract controller".</p>



		<ul style="list-style-type: none"> <li>Methods in this controller are very similar to method in controller „Contract change notification controller“. Differences are highlighted in green.</li> </ul> <p>Note: The controller “Contract change notification controller” and its methods will be eliminated after “Notification contract controller” implementation date + 6 months</p>
0.7.56	2022-06-29	Removed errors 112, 116, 108 for NTK (new supplier change) process. Method: <ul style="list-style-type: none"> <li>POST /gateway/notification/contract</li> </ul>
0.7.57	2022-06-30	Added json field ‘anotherSupplierContractCancellation’ in method: <ul style="list-style-type: none"> <li>POST /gateway/notification/contract/list?first={integer}&amp;count={integer}&amp;sortOrder={ASC/DSC}</li> </ul>
0.7.58	2022-07-14	Added json request parameters ‘supplierContractNo’, ‘objectAddressSearch’ in method: <ul style="list-style-type: none"> <li>POST /gateway/notification/contract/list?first={integer}&amp;count={integer}&amp;sortOrder={ASC/DSC}</li> </ul>
0.7.59	2022-07-15	Added new controller “Access right controller – new”.  This controller will be deployed in the future, preliminary date – 10.01.
0.7.60	2022-07-20	Added new controller “NotificationCancelation - new” This controller will be deployed in the future, preliminary date – 09.01.  Added new controller “Notification contract object supply state controller” This controller will be deployed in the future, preliminary date – 10.01.
0.7.61	2022-07-22	Changed the parameter objectNumber into objectNumbers and a maximum of 500 objects can be specified. Method: <ul style="list-style-type: none"> <li>POST /gateway/object/all/active/list?first={integer}&amp;count={integer}&amp;sortKey={string}&amp;sortOrder={ASC/DSC}</li> </ul>
0.7.62	2022-07-25	Added response the new field “powerPlantType”. Method: <ul style="list-style-type: none"> <li>POST /gateway/object/all/active/list?first={integer}&amp;count={integer}&amp;sortKey={string}&amp;sortOrder={ASC/DSC}</li> </ul>
0.7.63	2022-07-27	Edited rule 21 in method: <ul style="list-style-type: none"> <li>POST /gateway/notification/contract</li> </ul> Edited rule 416 in method: <ul style="list-style-type: none"> <li>POST /gateway/notification/contract/contact</li> </ul> Changes in methods are highlighted in blue.
0.7.64	2022-08-05	Added json field “cancelledByAnotherSupplier” in method: <ul style="list-style-type: none"> <li>POST /gateway/notification/contract/list?first={integer}&amp;count={integer}&amp;sortOrder={ASC/DSC}</li> </ul>
0.7.65	2022-08-25	Error 116 is returned in NTK (new supplier change) process: <ul style="list-style-type: none"> <li>POST /gateway/notification/contract</li> </ul>
0.7.66	2022-08-26	Edited rule 606 and added 607 rule in method: <ul style="list-style-type: none"> <li>POST /gateway/notification/cancellation</li> </ul>
0.7.67	2022-08-31	Restored the parameter objectNumbers into objectNumber in method:

		<ul style="list-style-type: none"> <li>• POST /gateway/object/all/active/list?first={integer}&amp;count={integer}&amp;sortKey={string}&amp;sortOrder={ASC/DSC}</li> </ul>
0.7.68	2022-09-02	Edited 3001 error message in method: <ul style="list-style-type: none"> <li>• POST /gateway/access-right</li> </ul>
0.7.69	2022-09-07	Removed "Contract change notification controller"
0.7.70	2022-09-20	Added json field "meterAutomated" and edited 3 rule in method: <ul style="list-style-type: none"> <li>• POST /gateway/declaration/reading/list?first={integer}&amp;count={integer}&amp;sortKey={string}&amp;sortOrder={ASC/DSC}</li> </ul>
0.7.71	2022-09-30	Added json field "timeZone" in method: <ul style="list-style-type: none"> <li>• GET/gateway/order/{orderId}/report-obj</li> </ul>
0.7.72	2022-10-03	Added new rule 8 in method: <ul style="list-style-type: none"> <li>• POST /gateway/notification/contract/object/supply-state</li> </ul>
0.7.73	2022-10-04	Added json field "orderParametersSearch" in method: <ul style="list-style-type: none"> <li>• POST/gateway/order/list?first={integer}&amp;count={integer}&amp;sortKey={string}&amp;sortOrder={ASC/DSC}</li> </ul>
0.7.74	2022-10-10	Added the new error message 2007: <ul style="list-style-type: none"> <li>• POST/gateway/order/{hr15OrderShortName}</li> </ul>
0.7.75	2022-10-11	Added the new json field "productConsumptionType" in method: <ul style="list-style-type: none"> <li>• GET/gateway/order/{orderId}/bill-2s2s-b2b</li> </ul>
0.7.76	2022-10-17	Added the new json field in method: <ul style="list-style-type: none"> <li>• POST /gateway/object/all/active/list?first={integer}&amp;count={integer}&amp;sortKey={string}&amp;sortOrder={ASC/DSC}</li> </ul> <p>"metersAmount":"integer",  "autoMetersAmount":"integer",  "smartMeterInstallationDate":"date",  "meterAutomated":"boolean",  "automationSystem":"string"</p>
0.7.77	2022-10-18	Added new methods: <ul style="list-style-type: none"> <li>• POST/gateway/order/data-hr-15min-mtr-lvl-acr</li> <li>• POST/gateway/order/data-hr-15min-obj-lvl-acr</li> <li>• POST/gateway/order/data-sum-obj-lvl-acr</li> <li>• POST /gateway/order/report-obj-acr</li> <li>• GET /gateway/order/{orderId}/data-hr-15min-obj-lvl-acr?first={integer}&amp;count={integer}</li> <li>• GET /gateway/order/{orderId}/data-hr-15min-mtr-lvl-acr?first={integer}&amp;count={integer}</li> <li>• GET /gateway/order/{orderId}/report-obj-acr?first={integer}&amp;count={integer}</li> <li>• GET /gateway/order/{orderId}/data-sum-obj-lvl-acr?first={integer}&amp;count={integer}</li> </ul>
0.7.78	2022-10-24	Added the new error message 2009: POST/gateway/order/data-sum-obj-lvl-acr

**Note:** Changes in table marked in white are already deployed, marked in green will be deployed in near future.

## 2. Preface

The Common Data Exchange Platform (hereinafter referred as *DH Platform*) Gateway is a component enabling independent electricity suppliers to directly access DH Platform from within their IT systems and thus helps automate the following business processes:

- Obtaining electricity consumption history data with the purpose of providing commercial proposals for the potential clients – residential and industrial electricity consumers
- Providing information to Distribution System Operator about the new contracts with the clients who have switched their supplier

DH Gateway provides open standards-based interfaces allowing independent suppliers themselves (or with outside assistance) integrate their IT systems with DH Platform.

This document provides technical information on DH Gateway interfaces which is needed to integrate suppliers' information systems with DH Platform.

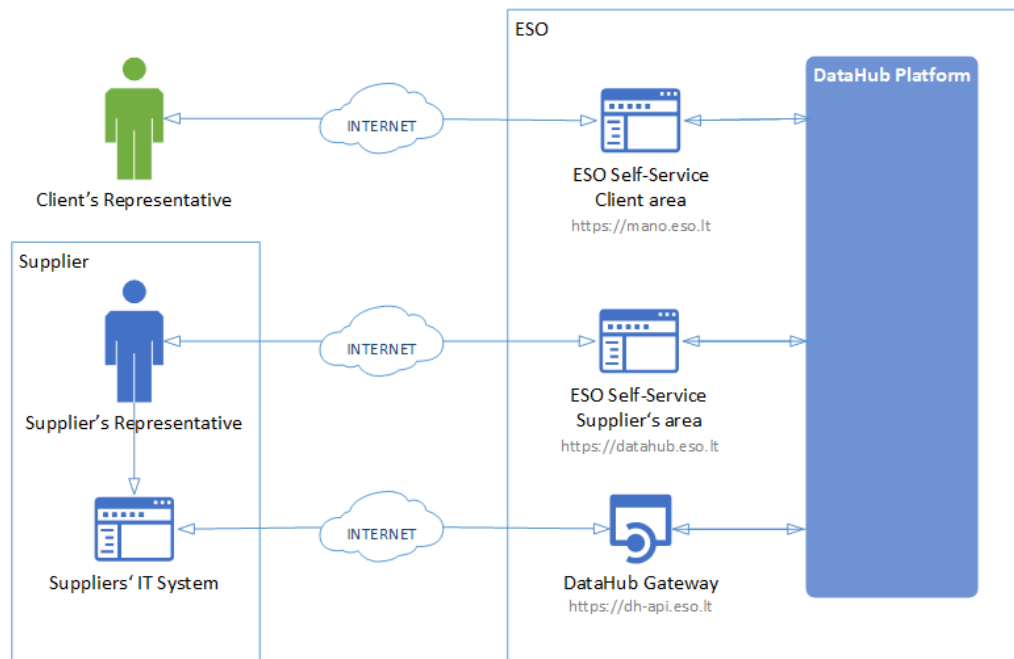

### 3. Definitions and abbreviations

Definition / abbreviation	Description
DH Gateway	DH Platform component enabling independent supplier's IT systems to directly access the platform and achieve a higher level degree of process automation.
DH, DH Platform	Common Data Exchange Platform.
Client	A household or legal person using electricity for the needs of the holding or business.
Client's Representative	A household person or his representative Representative of a legal entity (i.e. employee of a legal entity)
DSO, ESO	Distribution System Operator – AB „Energijos skirstymo operatorius“
Object	A site where electricity consumption takes place.
Supplier	Independent electricity supplier.
Supplier's Representative	Independent electricity supplier's employee representing the supplier.

### 4. Environments

There are two DataHub Gateway environments the supplier might access:

- “Sandbox” environment
- Production environment

DataHub Sandbox environment made of Mock API Gateway with mock requests and responses (scenarios). There are no connection to database or any data source, all possible requests and answers are hard-coded into mock API source code and has no any data selection logic or rules. This data is real depersonalized data from DSO customers. Sandbox requests and responses scenarios will be provided in additional document and it should be used just for preparation to integrate with DataHub production API environment or testing purposes.

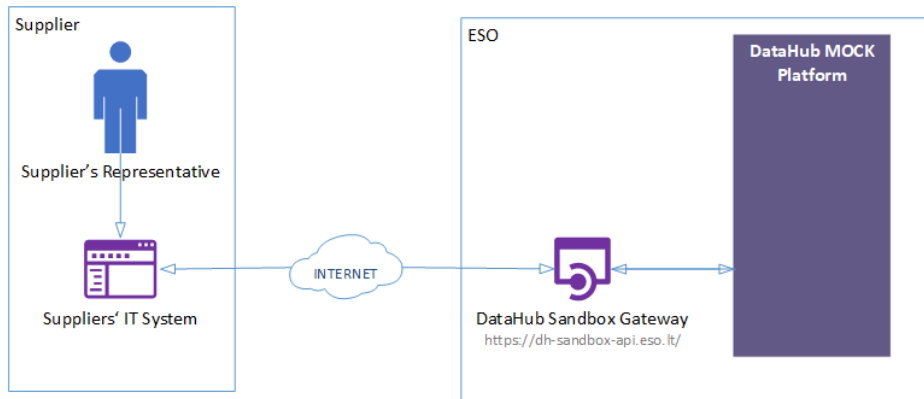

DataHub platform also has WEB interface, which is connected to DataHub Production Gateway. All environments are provided in the table:

Environment	Link	Swagger Link	WEB Interface
Production	<a href="https://dh-api.eso.lt">https://dh-api.eso.lt</a>	<a href="https://dh-api.eso.lt/swagger-ui.html">https://dh-api.eso.lt/swagger-ui.html</a>	<a href="https://datahub.eso.lt/">https://datahub.eso.lt/</a>
Sandbox	<a href="https://dh-sandbox-api.eso.lt">https://dh-sandbox-api.eso.lt</a>	<a href="https://dh-sandbox-api.eso.lt/swagger-ui.html">https://dh-sandbox-api.eso.lt/swagger-ui.html</a>	-

## 5. Suppliers' digital certificates

In both the testing and production environments of the DH Gateway component, the identity of the supplier is established using a TOKEN, which the supplier's information system must provide each time the DH Gateway network service is called.

### To get started:

1. The DSO responsible person sends the JWT key (JSON Web Token) to be used with each request to the DH API.
2. To make requests to the DataHub Gateway API - the TOKEN submission in the case of cUrl takes place.

```
curl --header 'Authorization: Bearer key_received_from_DSO' https://dh-sandbox-api.eso.lt/data/data-orders/1/data
```

## 6. Recommendation for API client

### 6.1 SYNC

#### Sequential approach with pagination:

Should be default option

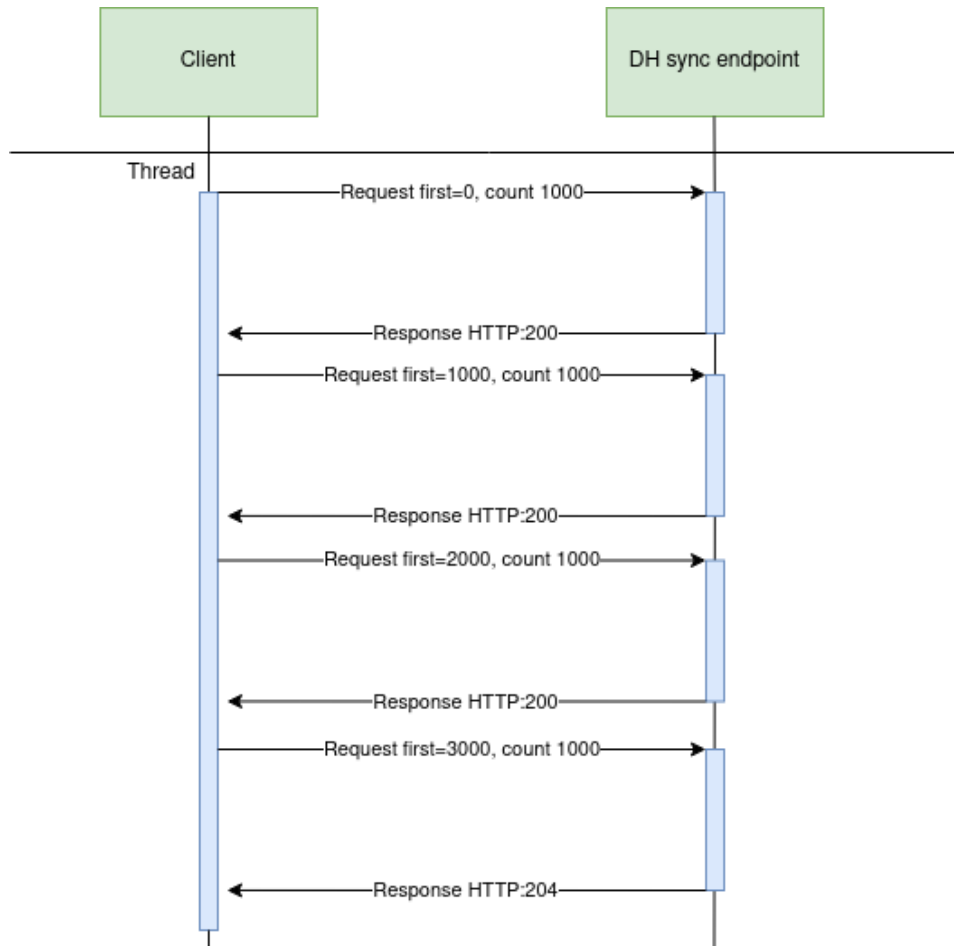

### Parallel approach with pagination

Could be used than import time is not reasonable. But parallel requests should be limited.

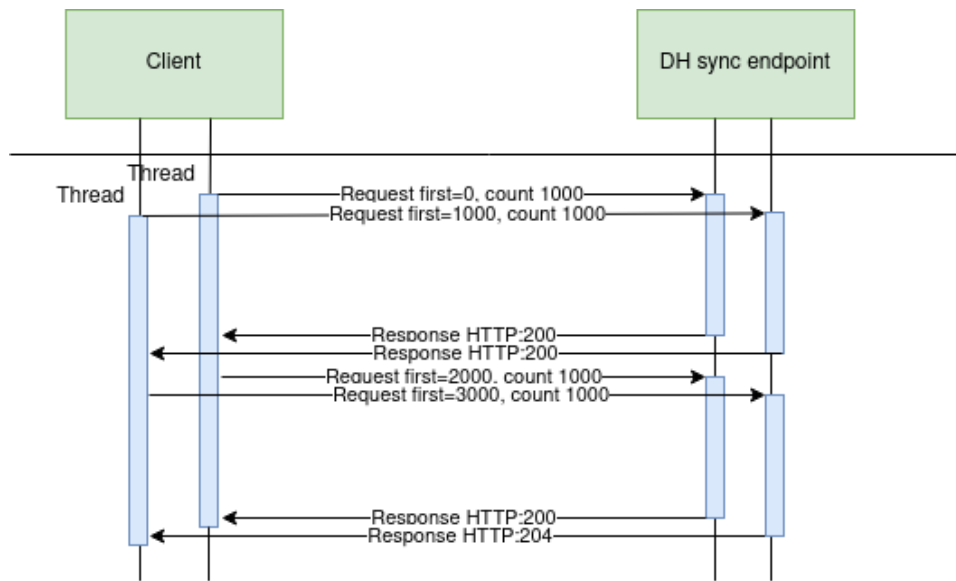

Recommendations for datahub client:

1. Parameter for page size control
2. Parameter for parallel thread amount control
3. Sequentially process should be default, but if import takes too much time, parallel process could be used but with max 3 threads.
4. Page size can be calculated by formula  $PS = PST/THRA$ , where PS - page size, PST - page size with which request takes less than 15 seconds to execute, THRA - thread amount. But not more than 10 000 records.
5. Retry on HTTP statuses: 429, 5xx
6. Retry should restart failed request only (not whole import process)
7. Retry interval should be not less than 5 seconds.
8. Import process should be able to continue process after failure

Motivation to have these features

1. Performance issues can arise accidentally and solving them can take some time. So, during performance problem page size and thread amount control could help.
2. Datahub has planned and unplanned deployments also can be incidents and during them datahub services might be unavailable. In this case from the client side is nice to have a fallback process which retries failed requests and continues the process after service becomes available again.
3. In the future throttling by independent supplier will be introduced and some of the requests could end up with http status 429 (too many requests) so retry process also will be helpful here.

## 7. DataHub Gateway API documentation

### 7.1 Declaration controller

Declaration controller provides information about API methods intended for objects non smart meters data declaration amount for DSO.

It is recommended to use these methods in Supplier's user interface system or other internal system which collect or allows to provide meter related data. GET and POST methods can be used suppliers Self-Service portals to let suppliers customers declare for them self.

**i** Declaration data transfer Supplier ↔ DataHub ↔ DSO: Supplier provided data to DataHub Database as soon as possible are transfered to DSO Billing system (it is planning that can be up to 1 hour transaction delay). Every 30min data are synced from DSO Billing system to DataHub DataBase to provide information to Supplier (it is planning that data in DataHub Database can be 0-60min. age comparing with DSO Billing database.)

#### 7.1.1 GET /gateway/supplier/v3/get-declaration-data?first={integer}&count={integer}&customerId={string}&objectNumber={string}

<b>URI</b>	GET /gateway/supplier/v3/get-declaration-data?first={integer}&count={integer}&customerId={string}&objectNumber={string}		
<b>Description</b>	The supplier receives data on the latest known meter scale consumption of its customers objects.		
<b>Parameters</b>	<p><b>URL:</b></p> <p><i>first</i> - index (starting from 0) of the object that must be presented first in the return list. Optional. The default value is 0.  <i>count</i> - number of objects in the return list. Optional. The default value is 30.  <i>customerId</i> - user code of the contracted customer for data filtering  <i>objectNumber</i> - customer object number for data filtering</p>		
<b>Request Body</b>	GET request does not has BODY data model structure.		
<b>Response</b>	<b>HTTP status code</b>	<b>Reason</b>	<b>Response description</b>
	200	OK	Request completed successfully
	204	No Content	No data found according to the given parameters.



	400	Bad Request	Request error. The HTTP response body provides a list of errors in JSON format.
	401	Unauthorized	An attempt was made to connect to a non-public method that requires authentication, but no user credentials were provided.
	403	Forbidden	According to the access control policy, the current user does not have access to perform the requested action.
	404	Not Found	Either there is no API method associated with the request URL path that did not return the data.
<b>Rules</b>	<b>No.</b>	<b>Rule description</b>	<b>Attributes</b>
	1.	Customers and their objects belonging to the supplier are selected according to the supplier ID encrypted in the supplier identification key.	Authentication Key
	2.	<p>URL parameters are optional.</p> <p>First, count parameters describe a sample of data to return in a single request. By default, the first 30 data of the client object are returned (first: 0, count: 30). If the supplier specifies first, count parameters otherwise, then the data is returned according to the request sent by the supplier, but not more than 50 000;</p> <p> the maximum value per query can be 50 000 objects (max count&gt;=50 000). If the supplier specifies more than 50 000, an error message 12 is displayed.</p> <p>If the vendor does not specify customerId, objectNumber URL parameters, all vendor object scale data (depending on first, count parameters) must be returned to the vendor. If the supplier specifies both parameters, then it is checked whether the specified object number belongs to the specified customer and the scales of a specific object are derived. If an error occurs, error message code 2 is returned.</p> <p><b>first</b> - index (starting from 0) of the object that must be presented first in the return list. Optional. The default value is 0;</p> <p><b>count</b> - number of objects in the return list. Optional. The default value is 30;</p>	URL: first, count, customerId, objectNumber

	<p><b>customerId</b> - selection of object scale data according to customer number; By default, the first 30 objects of that client are output;</p> <p><b>objectNumber</b> - selection of object scale data according to the object number; By default, only the scale data of a specific object is output (First, count parameters lose their effect);</p>	
3.	The method returns only the scales of non-automated meters.	-
4.	The method returns only the valid scales of valid meters.	-
5.	The method returns the latest confirmed (in DSO Billing system) actual readingFrom value, if there are not actual - then average readingFrom value.	readingFrom
6.	The readingMin value is selected from the DSO Billing system and specifies the lowest possible declaration readingTo value.	readingMin, readingTo
7.	The scaleMaxChar value is selected from the DSO Billing system and specifies maximum number of chars which could be provided to readingTo scale field.	readingTo, scaleMaxChar
8.	<p>The method returns the readingSource of the latest confirmed (in DSO Billing system) readingFrom value.</p> <p>The readingSource can be:</p> <p>A - automatically scanned readings  D - your declared readings  L - checked readings  P - rewritten readings from a previous agreement  V - average readings  K - readings from credit document</p>	readingSource

### 7.1.1.1 JSON BODY Request structure

The table below describes the JSON structure and elements of the get-declaration-data request BODY:

JSON Request structure			
-			
Attribute	type	obligation	description

-	-	-	-
---	---	---	---

### 7.1.1.2 JSON URL Request structure

The table below describes URL request attributes:

JSON Request structure			
-			
Attribute	type	obligation	description
<b>first</b>	integer	not required	Index (starting from 0) of the object that must be presented first in the return list.
<b>count</b>	integer	not required	Number of objects in the return list.
<b>customerId</b>	string(32)	not required	Filtering data by supplier-owned user code of the contracted customer.
<b>objectNumber</b>	string(20)	not required	Filtering data by supplier-owned customer object number.

### 7.1.1.3 JSON Response structure

If the get-declaration-data request is successful, method will return JSON data model which is described below.

JSON Response structure
<pre>[ {   "clientId": "string",   "customerId": "string",   "clientName": "string",   "readings":[     {       "objectNumber": "string",       "objectAddress": "string",       "counterNumber": "string",       "scaleMaxchar": "number",       "conversionPoss": "string",       "scales": [         {</pre>

```

        "scaleId": "number",
        "scaleIdentifier": "string",
        "scaleType": "string",
        "readingFromDate": "dateTime",
        "readingFrom": "number",
        "readingMin": "number",
        "readingSource": "string"
    }
}
]
}
]

```

Attribute	type	obligation	description
<b>clientId</b>	string(20)	required	Client personal code if client is a resident (private customer) company code if client is a company (legal client)
<b>customerId</b>	string(32)	required	User code of the contracted customer
<b>clientName</b>	string(200)	required	Client name:  Name Surname - if household customer Company name - if a legal entity
<b>readings[]</b>			List of the declaration readings data
<b>readings[].objectNumber</b>	string(20)	required	objectNumber of the object for the supply of electricity in which the contract is concluded.
<b>readings[].objectAddress</b>	string(4000)	required	object address
<b>readings[].counterNumber</b>	string(20)	required	Meter number which was provided by the manufacturer
<b>readings[].scaleMaxchar</b>	number(3)	required	Field specifies maximum number of chars which could be provided i readingTo field.
<b>readings[].conversionPoss</b>	boolean	required	Scale possible conversion. Possible values:  true - possible conversion false - impossible conversion

<b>readings[].scales[]</b>			List of the scales
<b>readings[].scales[].scaleId</b>	number(8)	required	Scale ID which has to be provided when using POST method.
<b>readings[].scales[].scaleIdentifier</b>	string(50)	required	Internal scale identifier. Possible values:  VT DD DN +QsumTS +WsumT1 +WsumT2 +WsumT3 +WsumT4 -QsumTS -WsumTS
<b>readings[].scales[].scaleType</b>	string(2)	required	Internal scale product type. Possible values (VALUE - explanation):  D1 – day electricity D2 – evening electricity DD <sup>o</sup> – electricity at day tariff MA- maximum loads MI – minimum loads N1 – night electricity N2 – morning electricity NK – electricity at night, Saturday, Sunday tariff RG- reactive electricity generated RV – reactive electricity consumption SV – Saturdays, Sundays and holidays electricity VD – average loads VK - one time zone
<b>readings[].scales[].readingFromDate</b>	dateTime	required	Date indicating when the last declared reading was registered and confirmed in the ESO Billing system. Last known readingsFrom date.  Field format: YYYY-MM-DDThh:mm:ss
<b>readings[].scales[].readingFrom</b>	number(18)	required	Last declared reading value

<b>readings[].scales[].readingMin</b>	number(18)	not required	The minimum reading that can be provided by the Supplier or the customer in the Supplier Self-Service to the readingTo field in the POST method.
<b>readings[].scales[].readingSource</b>	string(1)	required	The reading source of the last declared reading value. Possible values (VALUE - explanation):  A - automatically scanned readings D - your declared readings L - checked readings P - rewritten readings from a previous agreement V - average readings K - readings from credit document

#### 7.1.1.4 Response Error codes

Below are the error codes and messages. Response codes and response content in case of error:

Code	Message	Explanation
2	"Object <objectNumber> not found or not belongs to You. Please check provided information."	A match between the supplier and the object number could not be found in the DataHub database.
12	"The maximum number of objects in one request is 50 000."	Supplier provide count attribute value which is more than 50 000. One request can return maximum 50 000 objects' information.

#### JSON Response example in case of error

```
{
  "errorMessages": [
    {
      "code": 0,
      "text": "string"
    }
  ]
}
```

#### 7.1.2 POST /gateway/declaration/reading/list

<b>URL</b>	POST /gateway/declaration/reading/list?first={integer}&count={integer}&sortKey={string}&sortOrder={ASC/DSC}		
<b>Description</b>	The method is intended to obtain the last declared data of the supplier's customer objects. The method is also designed to obtain changes in the declaration data.		
<b>Parameter</b>	<p><b>URL parameter:</b></p> <ul style="list-style-type: none"> <li>• <b>first</b> - index (starting from 0) of the object that must be presented first in the return list. Optional. The default value is 0.</li> <li>• <b>count</b> - number of objects in the return list. Optional. The default value is 10 000.</li> <li>• <b>sort</b> - sort the returned records by data. Optional. The default value is `objectNumber`. It can change and sort by `cdcDateTime`. If <b>sort</b> is not provided, the default value applies.</li> <li>• <b>sortOrder</b> - sort by ascending or descending order: ASD / DSC. Optional. The default value is `ASC`. If <b>sortOrder</b> is not provided, the default value applies.</li> </ul>		
<b>Header</b>	After decrypting the supplier authentication key, the supplier ID is used to select the data, X-SupplierId.		
<b>Request</b>	<pre>{   "objectNumber": "string",   "cdcDateTimeFrom": "datetime + timezone",   "cdcDateTimeTo": "datetime + timezone" }</pre>		
<b>Response HTTP code</b>	<b>HTTP status code</b>	<b>Reason</b>	<b>Description</b>
	200	Ok	Request completed successfully.
	204	No content	No data found according to the given parameters.
	400	Bad request	Request error. The HTTP response body provides a list of errors in JSON format. ( <i>Error response of the JSON structure below</i> ).
	401	Unauthorized	An attempt was made to connect to a non-public method that requires authentication, but no user credentials were provided.

	403	Forbidden	According to the access control policy, the current user does not have access to perform the requested action.
	404	Not Found	Either there is no API method associated with the request URL path, or the request contains one or more parameters that did not return the data.
<b>Response</b>	<pre>[   {     "objectNumber": "string",     "cdcDateTime": "datetime with timezone",     "meters": [       {         "conversionPoss": true,         "meterNumber": "string",         "meterScaleLength": number,         "meterAutoamt": boolean,         "readings": [           {             "scaleId": number,             "scaleIdentifier": "string",             "scaleProduct": "string",             "readingFromDate": "datetime",             "readingMin": number,             "readingFrom": number,             "readingSource": "string"           }         ]       }     ]   } ]</pre>		
<b>Error response</b>	<pre>{   "errorMessages": [     {       "code": 0,       "text": "string"     }   ] }</pre>		



		]			
		}			
Rule	No.	Rule description	Error code	Error	Attributes
	1.	Customers and their objects belonging to the supplier are returned according to the supplier ID (X-SupplierId) encrypted in the supplier identification key.	-	-	X-SupplierId, supplier identification key
	2.	The method returns all objects that have signed contracts.	-	-	-
	3.	<del>The method returns only the scales of non-automated meters.</del> All automatic and non-automatic meters are displayed. If an automatic meter is selected, the values "meterAutoamted": true and "readings": null are returned If a non-automatic meter is selected, the values "meterAutoamted": false and "readings": a full object with scales and readings are returned.	-	-	-
	4.	Only valid scales are returned where the current time falls between meter_scale_validity.valid_from and meter_scale_validity.valid_to.			scaleId
	5.	Only valid scale types (product types) are returned.	-	-	scaleProduct
	6.	The maximum value per query can be 10 000 objects (max count<=10 000). If the supplier specifies more than 10 000, an error message 12 is displayed.	12	The maximum number of objects in one request is 10 000.	-

### 7.1.2.1 JSON Request structure

The table below describes the structure of the JSON response:

No.	Attribute	Type	Obligation	Description
1.	objectNumber	string(20)	not required	Object number.
2.	cdcDateTimeFrom	dateTime + timezone	not required	Change date from of the object (inclusive).
3.	cdcDateTimeTo	dateTime + timezone	not required	Change date to of the object (inclusive).

### 7.1.2.2 JSON Response structure

The table below describes the structure of the JSON response:

No.	Attribute	Type	Obligation	Description
1.	objectNumber	String(20)	required	Object number.
2.	cdcDateTime	datetime with timezone	required	The last modified date of the object.
3.	meters[]			
3.1	meterNumber	String(20)	required	Meter number.
3.2	meterScaleLength	Integer	required	Field specifies maximum number of chars which could be provided readingTo field.
3.3	conversionPoss	boolean	required	Scale possible conversion. Possible values: <ul style="list-style-type: none"> <li>• true - possible conversion</li> <li>• false - impossible conversion</li> </ul>
3.4	meterAutomated	boolean	required	Automated meter feature.

No.	Attribute	Type	Obligation	Description
4.	readings[]			
4.1	scaleId	number(8)	required	Scale ID.
4.2	scaleIdentifier	string(10)	required	Internal scale identifier. Possible values: <ul style="list-style-type: none"> <li>- VT</li> <li>- DD</li> <li>- DN</li> <li>- +QsumTS</li> <li>- +WsumT1</li> <li>- +WsumT2</li> <li>- +WsumT3</li> <li>- +WsumT4</li> <li>- -QsumTS</li> <li>- -WsumTS</li> </ul>
4.3	scaleProduct	string(2)	required	Internal scale product. Possible values (VALUE - explanation): <ul style="list-style-type: none"> <li>- D1 – day electricity</li> <li>- D2 – evening electricity</li> <li>- DD“ – electricity at day tariff</li> <li>- MA- maximum loads</li> <li>- MI – minimum loads</li> <li>- N1 – night electricity</li> <li>- N2 – morning electricity</li> <li>- NK – electricity at night, Saturday, Sunday tariff</li> <li>- RG- reactive electricity generated</li> <li>- RV – reactive electricity consumption</li> <li>- SV – Saturdays, Sundays and holidays electricity</li> <li>- VD – average loads</li> <li>- VK - one time zone</li> </ul>
4.4	readingFromDate	dateTime	required	Date indicating when the last declared reading was registered and confirmed in the ESO Biling system. Last known readingsFrom date.

No.	Attribute	Type	Obligation	Description
				Field format: YYYY-MM-DDThh:mm:ss
4.5	readingFrom	number	required	Last declared reading value.
4.6	readingMin	number	not required	The minimum reading that can be provided by the Supplier or the customer in the Supplier Self-Service to the readingTo field in the POST method.
4.7	readingSource	string(2)	required	The reading source of the last declared reading value. Possible values (VALUE - explanation): <ul style="list-style-type: none"> <li>- A - automatically scanned readings</li> <li>- D - your declared readings</li> <li>- L - checked readings</li> <li>- P - rewritten readings from a previous agreement</li> <li>- V - average readings</li> </ul>

### 7.1.2.3 Error Response structure

The following table describes the JSON structure in the event of a response error:

No.	Attribute	Type	Obligation	Description
1.	code	number	required	Error code.
2.	text	string(4000)	required	Error message.

### 7.1.2.4 Algorithm for using DELTA solution

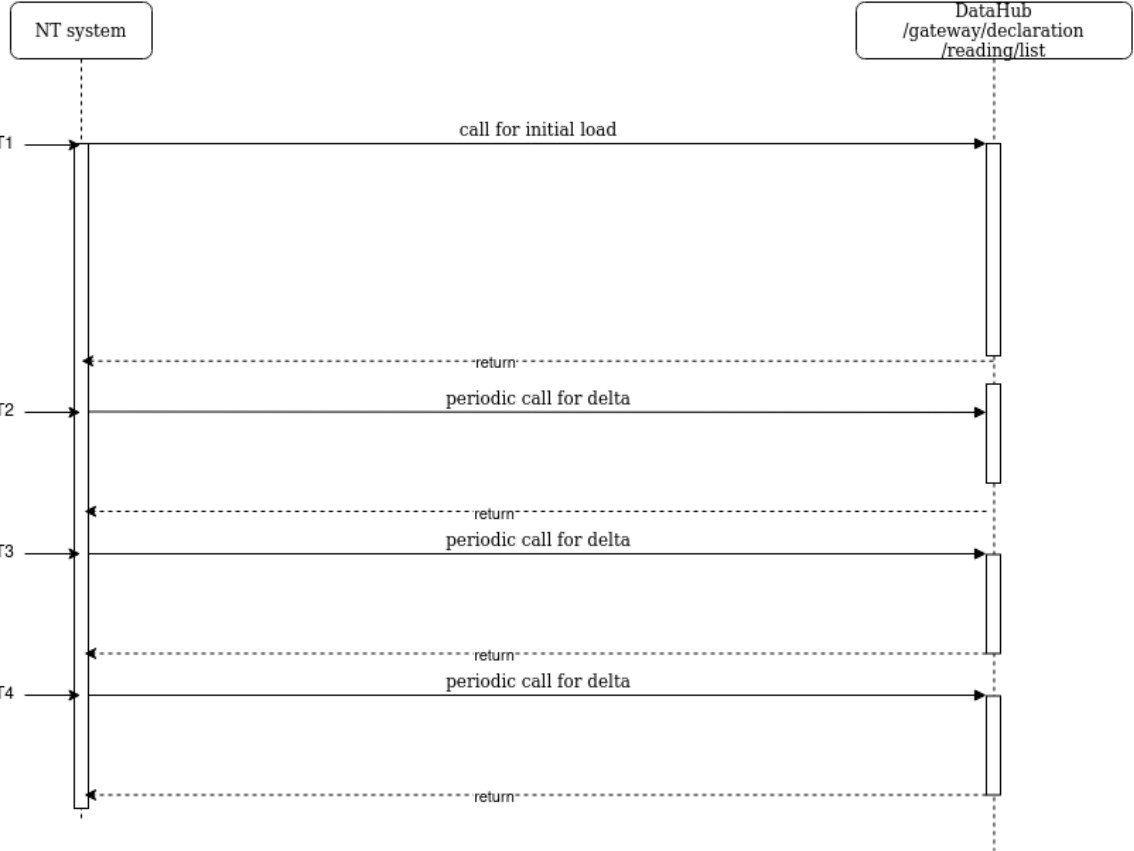

No.	Instructions for use	Stage	The value of the time variable	Request body
	 <pre> sequenceDiagram     participant NT as NT system     participant DataHub as DataHub /gateway/declaration /reading/list     Note over NT: T1     NT-&gt;&gt;DataHub: call for initial load     activate DataHub     DataHub--&gt;&gt;NT: return     deactivate DataHub     Note over NT: T2     NT-&gt;&gt;DataHub: periodic call for delta     activate DataHub     DataHub--&gt;&gt;NT: return     deactivate DataHub     Note over NT: T3     NT-&gt;&gt;DataHub: periodic call for delta     activate DataHub     DataHub--&gt;&gt;NT: return     deactivate DataHub     Note over NT: T4     NT-&gt;&gt;DataHub: periodic call for delta     activate DataHub     DataHub--&gt;&gt;NT: return     deactivate DataHub     </pre>			
1.	When starting a solution with the DELTA decision for the first time, an initial load must be performed first. The start time of the initial charge is saved.	Initial loading	TIME = T1	

No.	Instructions for use	Stage	The value of the time variable	Request body
2.	A request is sent to get the last declarations for all supplier objects. No parameters are specified in the query. The result is saved.	Initial loading		{}
3.	After the initial data load, regular data loads continue. The start time of the first regular charge is saved.	Regular loading	TIME = T2	
4.	A request is sent to receive a change in the declaration data of all the supplier's objects during the time period T2 - T1. In the query parameter <b>cdcDateTimeFrom</b> we specify the time T1. The result is saved.	Regular loading		{ "cdcDateTimeFrom":T1 }
5.	Periodically repeating steps from step 3.	Regular loading		

### 7.1.3 POST /gateway/supplier/send-declaration-data

<b>URI</b>	POST /gateway/supplier/send-declaration-data		
<b>Description</b>	The method is intended to provide readings of the scale declared by the object. The readings are given at the object level, so all counters on the full scale must be presented at the same time.		
<b>Parameters</b>	none		
<b>Request Body</b>	POST request structure provided in BODY		
<b>Response</b>	<b>HTTP status code</b>	<b>Reason</b>	<b>Response description</b>

	201	Created	Request completed successfully
	400	Bad Request	Request error. The HTTP response body provides a list of errors in JSON format.
	401	Unauthorized	An attempt was made to connect to a non-public method that requires authentication, but no user credentials were provided.
	403	Forbidden	According to the access control policy, the current user does not have access to perform the requested action.
	404	Not Found	Either there is no API method associated with the request URL path, or the request contains one or more parameters that did not return the data.
<b>Rules</b>	<b>No.</b>	<b>Rule description</b>	<b>Attributes</b>
	0.	If an attribute has defined possible values, the value index can be specified by specifying the value of the attribute in the request. Indices of all possible values start from 0.	All attributes with specified values.
	1.	Customers and their objects belonging to the supplier are selected according to the supplier ID encrypted in the supplier authentication key. It is checked whether the object number belongs to the supplier. If the object does not belong to the same supplier, output an error 10.  If the supplier wants to declare the data of the customer who no longer belongs to him, but belonged to the previous month, then the supplier can declare the data for the previous month on the first working day of the next month until 12:59:59 h.	Authentication key, objectNumber
	2.	Checked if all required fields are filled. If on of the field left blank, error 1 is displayed.	All attributes
	3.	The date of the declared reading must be the day of the current month, except for the first working day of the month (it must be calculated when the first working day of the month is taking into account public holidays, eg 2021.01. The declaration must be closed on the first working day of the month at 12:59:59. It also checks that the date and time of dataWriteDate is not a future time compared to the server sysdate.	dataWriteDate

	<p>If error occur, error code 3 are displayed.</p> <p><b>Examples:</b></p> <p>Sysdate 2020-10-01 12:15, dataWriteDate 2020-08-30T16:55:00  Sysdate 2020-10-01 12:15, dataWriteDate 2020-09-01T00:55:00  Sysdate 2020-10-01 12:15, dataWriteDate 2020-10-01T08:00:00  Sysdate 2020-10-01 12:15, dataWriteDate 2020-10-01T08:00:00  Sysdate 2020-10-01 13:05, dataWriteDate 2020-10-01T09:00:00  Sysdate 2020-10-01 13:05, dataWriteDate 2020-09-25T15:55:00  Sysdate 2020-10-01 13:05, dataWriteDate 2020-10-25T08:00:00</p> <p>Lines (2-5) will be accepted, because comply requirement, other lines will be rejected, because period for August (1) and September (6) was closed and (7) because declaration in the future is not possible.</p> <p> Business process: For the reporting month, the declaration may be made no later than the first day of the post-reporting month 13:00:00, indicating that the readings provided is no later than the last day of the reporting month 23:59:59.</p>	
4.	<p>The maximum number of characters in the reading ReadingTo is checked. If the number of characters exceeds the specified number, output error message 4.</p> <p> The verification in the supplier's system shall be performed using the value of readings[].scaleMaxchar obtained in the parameters of the GET method.</p>	readingTo
5.	<p>The scale reading (readingTo) can only be integers (characters are not available). If the display is not an integer or the value has characters, error message no. 5.</p>	readingTo
6.	<p>The data types skId and dataWriteDate are checked. If the types do not meet the required requirements, message no. 6.</p>	skId, dataWriteDate
7.	<p>A reading smaller than the readingMin value cannot be declared if no scale conversion occurs. Check that readingTo is greater than or equal to the value of the declared scale readingMin and conversion = N. If scale conversion is possible, then this value may be less than readingMin.</p> <p>If an error occurs, message no. 5.</p>	readingTo, conversion
8.	<p>The conversion indicator may be provided if the "conversationPoss:T" is obtained for the said scale in the GET method and if the estimated consumption is less than half of the maximum consumption of the scale.</p>	conversion, readingTo



	<p><b>i</b> How the maximum consumption of the scale is calculated. For example, GET method returns "scaleMaxchar:5", then the maximum scale consumption can be 99999. If an error is detected, an error message 7 is displayed.</p>	
9.	<p>Readings can only be declared for valid scales. Checking that the scaleId of the specified scale is still valid. If the scale is no longer valid, an error message 8 is displayed.</p> <p><b>i</b> This error can usually occur if you make the declaration using data that is out of date.</p>	scaleId
10.	<p>If scaleId could not be found in the database, an error message 8 is displayed.</p>	scaleId
11.	<p>The value of the objectNumber attribute checks whether the user is household or commercial. If the consumer is household, it is permissible to specify the value of readingsTo such that after the mathematical operation readingsTo - readingsFrom &lt;= 20 000 (This parameter is configurable, the value of this parameter can change). (consumption &lt;=20 000 kwh).</p> <p><b>i</b> If the customer is household and the consumption is greater than 20 000 kwh, please contact DSO.</p> <p>If an error occurs, message 9 is displayed.</p>	readingsTo
12.	<p>Checks if the specified objectNumber can be found in the DataHub database. If it cannot be found, an error message 2 is displayed.</p>	objectNumber
13.	<p>It is mandatory to send the scales of all meters in the object at the same time. It is checked whether the supplier sends all the scales assigned to the specific object. The objectNumber selects all valid counters and scales valid in the counters (scaleId) assigned to the object. The declaration takes place in the context of the object and only the ALL scales of ALL the meters in the object are submitted.</p> <p>If at least one scale is missing, an error message is displayed 10.</p>	scaleId, objectNumber
14.	<p>Supplier cannot declare the data for the object if the contractType = SBTS and belongs to the public supplier. An error message 14 is displayed.</p>	objectNumber
15.	<p>Supplier cannot declare the data for the object if the <i>db.object_meter meter_automated is false</i>. An error message 15 is displayed.</p>	scaleId, object_meter_ID, meter_automated

### 7.1.3.1 JSON Request structure

The table below describes the JSON structure and elements of the send-declaration-data request:

JSON Request structure

```
[
{
  "objectNumber": "string",
  "dataWriteDate": "date",
  "readings":[
    {
      "reading": [
        {
          "sklId ": "number",
          "readingTo": "number",
          "conversion": "string"
        }
      ]
    }
  ]
}
]
```

Attribute	type	obligation	description
<b>objectNumber</b>	string(20)	required	objectNumber of the object for the supply of electricity in which the contract is concluded.
<b>dataWriteDate</b>	dateTime	required	the date when the meter data was written off Date format: YYYY-MM-DDTHH:mm:ss
<b>readings[]</b>	list	required	List of the meters in the object
<b>readings[].reading[]</b>	list	required	List of the scales in the meter
<b>readings[].reading[].sklId</b>	number	required	scale ID number
<b>readings[].reading[].readingTo</b>	number(18)	required	Meter's scale written of value, which is provided by customer or supplier
<b>readings[].reading[].conversion</b>	boolean	required	The value of the scale conversion characteristic:  true - Yes, there was a conversion false - no, no conversion (default value)

### 7.1.3.2 JSON Response structure

If the declaration request is successful, method will not return any data model, but HTTP 201 Created status.

JSON Response structure			
If the request is successful, an <b>HTTP 201 Created</b> message is returned			
Attribute	type	obligation	description
-	-	-	-

### 7.1.3.3 Response Error codes

Below are the error codes and messages. Response codes and response content in case of error:

Code	Message	Explanation
4	<del>"All request parameters are required."</del>	<del>There is no provided one or more required attributes values.</del>
2	"Object <objectNumber> not found or not belongs to You. Please check provided information."	A match between the supplier and the object number could not be found in the DataHub database.
3	"Declaration data for the previous reporting period can no longer be provided (period was closed) or Your provide date shows future time."	The supplier tries to provide readings for the previous reporting period or the future. Future declarations are not possible and declarations for the previous reporting period can no longer be provided.
4	"Incorrect number of digits in <b>readingTo</b> field. Please check maximum number of digits in this scale."	Too many digits on the scale.
5	"Parameter <b>readingTo</b> is integer and can not be less than value <i>readingMin</i> . Please check this field value."	Only integer values are possible and value has to be greater or equal to readingMin value.
6	<del>"Incorrect data types."</del>	<del>There was provided incorrect data types in request.</del>

Code	Message	Explanation
7	"A conversion indicator may be provided if the estimated consumption is less than half of the maximum consumption of the scale and if the scale has a conversion indicator."	Scale reversal is possible only when the scale has an attribute that indicates the possibility of scale reversal.
8	"The scale <b>sklid</b> does not exist or is no longer valid."	The scale is no longer valid or does not exist.
9	"Data belongs to household client and declared meter value is more than 20 000. Please check data and try again."	A household customer is trying to declare more than 20 000 kwh. The parameter is configurable, the value of the parameter may change.
10	"The declaration process is performed in the context of the object. It has to be provided all meters with all scales which belongs to provided object. One of meter or scale is missing <a href="#">or meter automated</a> , please check provided data."	The meter scales are incomplete in the declared data.
11	<del>"objectNumber and customerId does not exist in DataHub Database."</del>	<del>We were unable to find a match between the object number and the customer code based on the information entered in the URL parameters.</del>
12	<del>"The maximum number of objects in one request is 50 000."</del>	<del>Supplier provide count attribute value which is more than 50 000. One request can return maximum 50 000 objects information.</del>
13	"Meter scales with ids <sklid, sklid> are repeating."	Meter scales cannot be repeated for the same object.
14	Readings not accepted. The object [objectNumber] belongs to a public supplier.	Declare data cannot be declared if the object belongs to a public supplier.

#### JSON Response example in case of error

```
{
  "errorMessages": [
    {
      "code": 0,
      "text": "string"
    }
  ]
}
```

Code	Message	Explanation
	<pre> } ] } </pre>	

## 7.2 Supplier change notification controller

Supplier shall notify DSO of the new electricity supply contracts signed with the clients who have switched supplier by submitting a special supplier change notifications (SCN's) to DataHub Gateway component.

The supplier's IT System creates and submits to DataHub Gateway supplier change notification request. A single request can contain one or more notifications. Upon receiving the request, DataHub Gateway validates the request, extracts notifications and submits them to DataHub Platform for further processing. In case of validation failure, DataHub Gateway responds with a list of errors and doesn't submit notifications to DataHub Platform – notification processing is performed on “all or nothing” basis.

### 7.2.1 POST /supplier/v2/supplier-change-notifications (new)

<b>URI</b>	POST /supplier/v2/supplier-change-notifications (new)		
<b>Description</b>	The supplier submits notifications on the contracts concluded by the supplier with customers (when changing the supplier). In this method version, supplier can register supplier change notification method by providing client ID (personal or company code) and all those client object numbers (which can be in different customer IDs).		
<b>Parameters</b>	none		
<b>Request Body</b>	POST request structure provided in BODY		
<b>Response</b>	<b>HTTP status code</b>	<b>Reason</b>	<b>Response description</b>
	201	Created	Request completed successfully

	400	Bad Request	Request error. The HTTP response body provides a list of errors in JSON format.
	401	Unauthorized	An attempt was made to connect to a non-public method that requires authentication, but no user credentials were provided.
	403	Forbidden	According to the access control policy, the current user does not have access to perform the requested action.
	404	Not Found	Either there is no API method associated with the request URL path, or the request contains one or more parameters that did not return the data.
<b>Rules</b>	<b>No.</b>	<b>Rule description</b>	<b>Attributes</b>
	0.	If an attribute has defined possible values, the value index can be specified by specifying the value of the attribute in the request. Indices of all possible values start from 0.	All attributes with specified values.
	1.	When submitting the message, is being checked whether one of the fields is filled in (clientId or customerId) and whether the clientPermission parameter is filled in correctly (has to be exact sentence as required).  If the clientId field is filled in, the clientPermission field is also mandatory, if the clientId is blank and not filled in, then the clientPermission field is optional and can also be blank.	clientId, customerId, clientPermission
	2.	Only one of two fields can be filled in at the time of reporting: clientId or customerId. If the clientId is filled in, then it is mandatory to check whether the clientPermission value is filled in. If the customerId is filled in, then the clientPermission field does not need to be filled in and submitted.	clientId, customerId, clientPermission
	3.	When submitting the notification, specifying clientId parameter, the supplier can specify all objects belonging to that person / company in the objects[] list.  And check if the clientPermission value is filled, which is required.	clientId, objects[], clientPermission

4.	<p>objects[] List is required element in all supplier change notification request types (using clientId or using customerId) where supplier must provide objectNumbers and contractTypes which are included in new contract with customer.</p> <p>If error occur, error code 44 will be displayed.</p>	objects[], contractType, objectNumber
5.	<p>If a contract is concluded with a household customer, the value of contractType can only be "TYPE_BSS".</p> <p> Exclusively, farmers can also contract by choosing another model.</p>	contractType
6.	<p>If the clientPermission text does not match the required value "I confirm that the consent of the specified person / company to enter into the contract has been obtained", error code 10 is displayed.</p>	clientPermission
7.	<p>During the submission of the notification, it is checked whether a contract for another or the same real estate has not been concluded for the object as of a later date. If the contract for the object has already been concluded, an error shall be provided and the date of entry into force of the latest contract for the object and the number of the object shall be indicated. Error code 112</p>	contractStart
8.	<p>An object may be included in no more than one contract with a supplier that specifies the same effective date of the contract. If error occur, error code 108 will be displayed.</p>	contractStart objectNumber
9.	<p>If there is no real estate contract object in the system (error 108, 112 does not work), it is checked whether the date of entry into force of the contract is given correctly:</p> <p>Notifications of the concluded contract must be submitted by the day of the month specified in the configuration, and the contract may enter into force at the earliest from the first day of the following month.</p> <ul style="list-style-type: none"> <li>• Ex.: configuration date is 18 d. <ul style="list-style-type: none"> <li>○ current date 2021-09-17 this is the earliest contract that can be concluded on October 1.</li> <li>○ current date 2021-09-20 this is the earliest contract that can be concluded on November 1.</li> </ul> </li> </ul> <p>If error occur, error code 113 will be displayed.</p>	contractStart

### 7.2.1.1 JSON Request structure

The table below describes the JSON structure and elements of the supplier change notification request:

## JSON Request structure

```
[
  {
    "clientId": "string",
    "customerid": "string",
    "contractNo": "string",
    "contractStart": "2020-02-05",
    "objects": [
      {
        "objectNumber": "string",
        "contractType": "string",
      }
    ],
    "clientPermission": "string"
  }
]
```

Attribute	type	obligation	description
<b>clientId</b>	string(20)	not required	Client personal code if client is a resident (private customer) company code if client is a company (legal client)
<b>customerid</b>	string(32)	not required	User code of the contracted customer
<b>contractNo</b>	string(30)	required	Supplier contract number with the customer
<b>contractStart</b>	Date	required	Date of entry into force of the contract to the nearest month. Format <b>YYYY-MM-DD</b> . Where  <b>YYYY</b> – year, <b>MM</b> – month, <b>DD</b> – day  Regardless of which day component is specified on the date, it is assumed to be equal to the first day of the month.
<b>objects</b>	List	required	List of object numbers. An element must consist of one or more objectNumber elements.
<b>objects[].objectNumber</b>	String(20)	required	objectNumber of the object for the supply of electricity in which the contract is concluded.



<b>objects[].contractType</b>	String(20)	required	Contract type. There are two possible meanings:  TYPE_BSS TYPE_2S2S
<b>clientPermission</b>	String(66)	not required	Required value: "I confirm that the consent of the specified person / company to enter into the contract has been obtained".   This value becomes mandatory ONLY when the supplier specifies the value of the <b>clientId</b> field (personal code or company code) when submitting the message. Otherwise, the field is optional.

### 7.2.1.2 JSON Response structure

If the supplier change notification request is successful, method will not return any data model, but HTTP 201 Created status.

JSON Response structure

If the request is successful, an **HTTP 201 Created** message is returned

```
[
{
  "id": "number"
}
]
```

Attribute	type	obligation	description
<b>id</b>	number	required	supplier change notification message ID number

### 7.2.1.3 Response Error codes

Below are the error codes and messages. Response codes and response content in case of error:

Code	Message	Explanation
------	---------	-------------

140	Customer "<personal or company code>" does not exist.	Value of company or personal code provided was not correct or was not found in DataHub Database.
2	"CustomerId could not be found".	Customer Code was not found DataHub Database.
130	Only one of the 2 fields must be filled in: "Customer ID" or "Person / Company code".	When importing messages, only one of the fields must be specified - "User code" or "Person / Company code".
135	At least one of the 2 fields must contain a customer code or a person / company code.	One of the parameters must be specified: the user code of the object client or the person / company code.  An error appears when no parameter is specified.
112	An information of the conclusion of the contract since "<date>" has already been submitted to the object "<object number>".	During the submission of the notification, it is checked whether a contract for another or the same real estate has not been concluded for the object as of a later date.
104	The object "<object number>" corresponding to the customer code "<customer code>" or the person / company code "<person / company code>" was not found in the system.	The combination of user code or person / company code and object code provided in the message must indicate an existing object.
108	An information of the conclusion of the contract with "<supplier name>" since "<date>" has already been submitted to the object "<object number>".	An object may be included in no more than one contract with a supplier that specifies the same effective date of the contract.
11	No supplier contract number with customer.	The notice of a new contract (when changing supplier) must include the number of the contract with the customer.
12	The length of the supplier's contract number with the customer exceeds the maximum allowed length (30).	The value of the number field of the supplier's contract with the customer must not exceed 30 characters.
21	The date of entry into force of the supplier's contract with the customer is not specified.	The notice of a new contract (change of supplier) must indicate the date of entry into force of the contract.
32	The length of the object client user code exceeds the maximum allowed length (32).	The value of the customer user code field must not exceed 32 characters.
41	Object code not specified.	The object code must be indicated in the notification of the new contract (when changing the supplier).
42	Object code length exceeds maximum length (20).	The value of the object code field must not exceed 20 characters.
51	Contract type not specified. Available types: 2S2S, BSS.	The correct contract type must be selected for the object

201	Invalid contract type: <invalid type>.	The specified contract type is not TYPE_BSS or TYPE_2S2S
43	The length of the object's personal / company code exceeds the maximum allowed length (20).	The value of the person or company code field must not exceed 20 characters.
10	The value of the clientPermission field is static and mandatory, so this field has only one required and possible value.	clientPermission field is empty or not correct.
202	Object number "{objectNumber}" repeats.	Object numbers can't repeats.
44	Object is not specified in the notification.	At least one object is required in the notification.
111	The effective date of the contract must be equal to the first day of the month.	The date of entry into force of the contract must be equal to the first day of the month.
113	The effective date of the contract must not be less than [date].	Notifications of the concluded contract must be submitted by the day of the month specified in the configuration, and the contract may enter into force at the earliest from the first day of the following month.
116	Due to possible duplication of information, such a notification to object "<object number>" is not possible. Please try after 30 minutes.	When submitting a new supplier change notification, the system must be checked for the presence of supplier_change_notification
117	For object "<object number>", a change of supplier notification is already in progress with the owner and supplier change request.	A change of supplier notice shall not be permitted if a change of owner and supplier notice is in progress. It should not be allowed only if the object number and the date of contract start force of the contract coincide in the notifications.

**JSON Response example in case of error**

```
{
  "errorMessages": [
    {
      "code": 0,
      "text": "string"
    }
  ]
}
```

**7.2.2 POST /supplier/cancel-supplier-change-notification**

<b>URI</b>	POST /supplier/cancel-supplier-change-notification		
<b>Description</b>	The supplier can cancel already submitted supplier change notification and in DataHub database message status become canceled.		
<b>Parameters</b>	none		
<b>Request Body</b>	POST request structure provided in BODY		
<b>Response</b>	<b>HTTP status code</b>	<b>Reason</b>	<b>Response description</b>
	201	Created	Request completed successfully
	400	Bad Request	Request error. The HTTP response body provides a list of errors in JSON format.
	401	Unauthorized	An attempt was made to connect to a non-public method that requires authentication, but no user credentials were provided.
	403	Forbidden	According to the access control policy, the current user does not have access to perform the requested action.
	404	Not Found	Either there is no API method associated with the request URL path, or the request contains one or more parameters that did not return the data.
<b>Rules</b>	<b>No.</b>	<b>Rule description</b>	<b>Attributes</b>
	0.	If an attribute has defined possible values, the value index can be specified by specifying the value of the attribute in the request. Indices of all possible values start from 0.	All attributes with specified values.
	1.	Message can be canceled [according to the configuration parameter] after submission. When [configuration parameter] passes, supplier change notification message can not be canceled.  New value - 14 days. It was 1 hour before the change.	-

### 7.2.2.1 JSON Request structure

The table below describes the JSON structure and elements of the supplier change notification request:

JSON Request structure			
<pre>{   "id": 0 }</pre>			
Attribute	type	obligation	description
id	number(10)	required	Supplier change notification message ID number

### 7.2.2.2 JSON Response structure

If cancel supplier change notification request is successful, method will not return any data model, but HTTP 201 Created status. In DataHub database message status become canceled.

JSON Response structure			
If the request is successful, an <b>HTTP 201 Created</b> message is returned			
Attribute	type	obligation	description
-	-	-	-

### 7.2.3 POST /supplier/client/client-objects-information (new)

This method is providing client information which can be used when calling supplier change notification method.

<b>URI</b>	POST /supplier/client/client-objects-information (new)		
<b>Description</b>	Method to find new or existing client information		
<b>Parameters</b>	none		
<b>Request Body</b>	Request data structure must be provided in BODY in JSON format		
Response	HTTP status code	Reason	Response description

	200	OK	Request completed successfully
	400	Bad Request	Request error. The HTTP response body provides a list of errors in JSON format.
	401	Unauthorized	An attempt was made to connect to a non-public method that requires authentication, but no user credentials were provided.
	403	Forbidden	According to the access control policy, the current user does not have access to perform the requested action.
	404	Not Found	Either there is no API method associated with the request URL path, or the request contains one or more parameters that did not return the data.
<b>Rules</b>	<b>No.</b>	<b>Rule description</b>	<b>Attributes</b>
	0.	If an attribute has defined possible values, the value index can be specified by specifying the value of the attribute in the request. Indices of all possible values start from 0.	All attributes with specified values.
	1.	<p>Must meet one of the following conditions:</p> <p>The values specified in the fields: <b><i>clientId</i></b> and <b><i>clientPermission</i></b></p> <p>OR</p> <p>The values specified in the fields: <b><i>customerID</i></b> and <b><i>clientPermission</i></b></p> <p>OR</p> <p>The values specified in the fields: <b><i>objectNumber</i></b> and <b><i>clientPermission</i></b></p> <p>OR</p> <p>The values specified in the fields: <b><i>customerID</i></b> and <b><i>clientId</i></b> and <b><i>clientPermission</i></b></p> <p>OR</p> <p>The values specified in the fields: <b><i>objectNumber</i></b> and <b><i>clientPermission</i></b></p> <p>OR</p>	ALL

		All attributes are filled in, then is being checked whether all the information belongs to the specified customer.	
	2.	When calling the method, is being checked whether at least one of the fields is filled in.	<b>clientId</b> <b>customerId</b>
	3.	If both fields are filled in during the method call, is being checked whether the specified customer code belongs to this customer according to the specified personal code or company code.	<b>clientId</b> <b>sustomerId</b>
	4.	Required field. Checking if the supplier has specified the following specific sentence:  <i>"I confirm that the consent of the specified person / company has been obtained to see the data of the list of objects belonging to him (customer code, object number, object address and current contract model)"</i>	<b>clientPermission</b>

### 7.2.3.1 JSON Request structure

The table below describes the JSON structure and elements of client object information request:

JSON Request structure			
<pre>[   {     "clientId": "string",     "customerId": "string",     "objectNumber": "string",     "clientPermission": "string"   } ]</pre>			
Attribute	type	obligation	description
<b>clientId</b>	string(20)	not required	Client personal code if client is a resident (private customer) company code if client is a company (legal client)
<b>customerId</b>	string(32)	not required	User code of the contracted customer

<b>objectNumber</b>	String(20)	not required	objectNumber of the object for the supply of electricity.
<b>clientPermission</b>	String(66)	required	Required value: "I confirm that the consent of the specified person / company has been obtained to see the data of the list of objects belonging to him (customer code, object number, object address and current contract model)"

### 7.2.3.2 JSON Response structure

The table below describes the JSON structure and elements of client object information response:

JSON Response structure			
<pre>[   {     "customerID": "string",     "clientId": "string",     "objectInformation": [       {         "objectNumber": "string",         "objectAddress": "string",         "contractType": "string",         "automationLevel": "string"       }     ]   } ]</pre>			
Attribute	type	obligation	description
<b>customerID</b>	String(32)	required	User code of the contracted customer
<b>clientId</b>	string(20)	required	Client personal code if client is a resident (private customer) company code if client is a company (legal client)
<b>objectInformation[]</b>	List	required	The list of the object information



<b>objectInformation[].objectNumber</b>	String(20)	required	The object number
<b>objectAddress</b>	String(4000)	required	Address of the object.
<b>objectInformation[].contractType</b>	String(20)	required	Contract type. There are 2 possible values:  BSS 2S2S
<b>objectInformation[].automationLevel</b>	String(7)	not required	Object accounting automation level.  Possible values:  none partial full

### 7.2.3.3 Response Rules

No.	Rule explanation	Attribute
1.	If the customer does not have a contract with the supplier which is calling this API method, then the value of <b>clientId</b> will be "masked". Only the last 4 digits are displayed, and all others are converted to asterisks.  Example. *****1234	<b>clientId</b>

### 7.2.3.4 Response Error codes

Below are the error codes and messages. Response codes and response content in case of error:

Code	Message	Explanation
1	" <b>clientId</b> is not correct or not found in DataHub database. Please try again, or contact support"	Value of company or personal code provided was not correct or was not found in DataHub Database.
2	" <b>customerId</b> is not correct or not found in DataHub database.	Customer Code was not found DataHub Database.

3	" <b>clientId</b> and <b>customerId</b> did not match in DataHub database."	The user code could not be found according to the provided personal code or company code (in other words, the user code belongs to another person or company).
4	"Incorrect data types."	One of the attribute content type was provided incorrectly.
5	" <b>clientId</b> , <b>customerId</b> or <b>objectNumber</b> is required. Please specify one of these parameters."	One of the fields <b>clientId</b> , <b>customerId</b> or <b>objectNumber</b> must be filled.
6	" <b>clientPermission</b> field is required and it has only one possible value which is provided in Your agreement/documentation."	The string content in the <b>clientPermission</b> query field does not match the required string content.
7	Object information could not be found. Please try provide only one of the parameters or check if all provided information belongs to the same customer.	Failed to find object in DataHub DataBase. Could not find a match for all of the specified attributes by the provider ( <b>clientId</b> , <b>customerId</b> , <b>objectNumber</b> ) or customer does not exist in DataHub DataBase.

#### Response example in case of error

```
{
  "errorMessages": [
    {
      "code": 0,
      "text": "string"
    }
  ]
}
```

## 7.3 Access right controller – new *(will be deployed in the future, preliminary date – 12.01)*

### 7.3.1 POST/gateway/access-right/list

<b>URI</b>	POST /gateway/access-right/list?first={integer}&count={integer}&sortKey={string}&sortOrder={ASC/DSC}
<b>Description</b>	The method to obtain information and a list of granted rights.
<b>Parameters</b>	<b>URL:</b>

	<ul style="list-style-type: none"> <li>• first - index (starting from 0) of accessRightId that must be presented first in the return list. Optional. The default value is 0.</li> <li>• count - number of accesRightUuid in the return list. Optional. The default value is 30.</li> <li>• sort - optional. The default value is accessRightId</li> <li>• sortOrder - possible values ASD,DSC. Optional. The default value is ASD.</li> </ul> <p>The data of the JSON form request are presented in the HTTP request body (BODY) (Query JSON <b>structure, below</b>).</p>		
<b>Header</b>	After decrypting the supplier authentication key, the supplier ID is used to select the data.		
<b>JSON request</b>	<pre>{ "accessRightId":"number" "personCode":"string", "consumerCode":"string", "objectNumber":"string", "objectAddressSearch":"string", "accessRightValidFrom":"date", "accessRightValidTo":"date", "accessRightSource":"string", "generatingObjectType":"string", "contractType":"string", "contractModel":"string", "supplierType":"string", "powerPlantType":"string", "userNameSearch":"string" }</pre>		
<b>Response HTTP code</b>	<b>HTTP status code</b>	<b>Reason</b>	<b>Description</b>
	200	OK	Request completed successfully
	204	No Content	No data found according to the given parameters.
	400	Bad Request	Request error. The HTTP response body provides a list of errors in JSON format.

	401	Unauthorized	An attempt was made to connect to a non-public method that requires authentication, but no user credentials were provided.
	403	Forbidden	According to the access control policy, the current user does not have access to perform the requested action.
	404	Not Found	Either there is no API method associated with the request URL path, or the request contains one or more parameters that did not return the data.

**JSON response**

```
[
  {
    "accessRightId":"number",
    "accessRightValidFrom":"datetime",
    "accessRightValidTo":"datetime",
    "daysLeft":"number",
    "accessRightSource":"string",
    "userName":"string",
    "objectNumber":"string",
    "generatingObjectType":"string",
    "objectAddress":"string",
    "contractModel":"string",
    "supplierType":"string",
    "tariffPlan":"string",
    "timeZone":"string",
    "powerPlantType":"string",
    "automationLevel":"string",
    "contractType":"string",
    "personName":"string",
    "personSurname":"string",
    "personCode":"string",
    "consumerCode":"string",
    "accessRightPhoneNo":"string",
    "accessRightEmailAddress":"string",
    "accessRightNote":"string"
  }
]
```

	<pre> } ] </pre>				
<b>JSON error response</b>	<pre> {   "errorMessages":   [     {       "code": 0,       "text": "string"     }   ] } </pre>				
<b>Rules</b>	<b>No.</b>	<b>Rule description</b>	<b>Error code</b>	<b>Error message</b>	<b>Attributes</b>
	1.	One or more request parameters are required..	1001	One or more request parameters are required.	-
	2.	DateFrom cannot be later than DateTo. Equal can be.	1002	DateFrom cannot be later than DateTo.	-
	3.	Only valid, irrevocable access rights granted must be included in the list.	-	-	-

### 7.3.1.1 JSON Request structure

The table below describes the structure of the JSON request:

No.	Attribute	type	obligation	description
1.	accessRightId	number	not required	Access right number (ID).
2.	personCode	string(20)	not required	Person code.
3.	consumerCode	string(20)	not required	Consumer code.
4.	objectNumber	string(20)	not required	Object number.
5.	objectAddressSearch	string(4000)	not required	Object address search.
6.	accessRightValidFrom	date	not required	Access right valid date From.
7.	accessRightValidTo	date	not required	Access right valid date To.
8.	accessRightSource	string(1)	not required	Access right source. Possible meanings: <ul style="list-style-type: none"> <li>• ESO-S – Per ESO-S;</li> <li>• NT – Per NT;</li> </ul>
9.	generatingObjectType	string(1)	not required	Generating object type. Possible meanings: <ul style="list-style-type: none"> <li>• G – GV (Gaminantis vartotojas);</li> <li>• N – NGV (Nutoles gaminantis vartotojas).</li> </ul>
10.	contractType	string(10)	not required	Contract type. Possible meanings:

No.	Attribute	type	obligation	description
				<ul style="list-style-type: none"> <li>• SBTS - Buitinė sutartis;</li> <li>• SKMS - Komercinė sutartis.</li> </ul>
11.	contractModel	string(10)	not required	Contract model. Possible meanings: <ul style="list-style-type: none"> <li>• BSS - Bendra sutartis ir sąskaita;</li> <li>• 2S2S - Dvi sutartys – dvi sąskaitos.</li> </ul>
12.	supplierType	string(2)	not required	Supplier type. Possible meanings: <ul style="list-style-type: none"> <li>• VT - visuomeninis tiekėjas;</li> <li>• GT - garantinis tiekėjas;</li> <li>• NT - nepriklausomas tiekėjas.</li> </ul>
13.	powerPlantType	string(1)	not required	Power plant type. Possible meanings: <ul style="list-style-type: none"> <li>• A – Atliekų;</li> <li>• B – Biomasės;</li> <li>• H – Hidroelektrinė;</li> <li>• K – Kita;</li> <li>• S – Saulės;</li> <li>• T – TEC;</li> <li>• V – Vėjo.</li> </ul>
14.	userNameSearch	string(240)	not required	User name search.

### 7.3.1.2 JSON Request structure

The table below describes the structure of the JSON response:

No.	Attribute	type	obligation	description
1.	accessRightId	number	required	Access right number (ID).

No.	Attribute	type	obligation	description
2.	accessRightValidFrom	datetime	required	Access right valid date From.
3.	accessRightValidTo	datetime	required	Access right valid date To.
4.	daysLeft	number	required	Number of days, how long the access right is still valid.
5.	accessRightSource	string(1)	required	Access right source. Possible meanings: <ul style="list-style-type: none"> <li>• ESO-S – Per ESO-S;</li> <li>• NT – Per NT;</li> </ul>
6.	userName	string(240)	required	The user who added the granted right.
7.	objectNumber	string(20)	required	Object number.
8.	generatingObjectType	string(1)	not required	Generating object type. Possible meanings: <ul style="list-style-type: none"> <li>• G – GV (Gaminantis vartotojas);</li> <li>• N – NGV (Nutoļes gaminantis vartotojas).</li> </ul>
9.	objectAddress	string(4000)	required	Object address.
10.	contractModel	String(10)	required	Contract model. Possible meanings: <ul style="list-style-type: none"> <li>• BSS - Bendra sutartis ir saškaita;</li> <li>• 2S2S - Dvi sutartys – divi saškaitos.</li> </ul>
11.	supplierType	string(2)	required	Supplier type. Possible meanings: <ul style="list-style-type: none"> <li>• VT - visuomeninis tiekējas;</li> <li>• GT - garantinis tiekējas;</li> </ul>



No.	Attribute	type	obligation	description
				<ul style="list-style-type: none"> <li>• NT - nepriklausomas tiekėjas.</li> </ul>
12.	tariffPlan	String(200)	not required	Tariff plan of object.
13.	timeZone	String(2)	not required	<p>Time zone of object. Possible meanings:</p> <ul style="list-style-type: none"> <li>• 1 - One;</li> <li>• 2 - Two;</li> <li>• VR - One with reactive;</li> <li>• 4 - Four (Smart);</li> <li>• DR - Differentiated with reactive;</li> <li>• N - Not established.</li> </ul>
14.	powerPlantType	string(1)	not required	<p>Power plant type. Possible meanings:</p> <ul style="list-style-type: none"> <li>• A – Atlieky;</li> <li>• B – Biomasės;</li> <li>• H – Hidroelektrinė;</li> <li>• K – Kita;</li> <li>• S – Saulės;</li> <li>• T – TEC;</li> <li>• V – Vėjo.</li> </ul>
15.	automationLevel	string(1)	required	<p>Automation level. Possible meanings:</p> <ul style="list-style-type: none"> <li>• FULL - Pilna;</li> <li>• PARTIAL - Dalinė;</li> <li>• NONE - Nėra.</li> </ul>
16.	contractType	String(10)	required	<p>Contract type. Possible meanings:</p> <ul style="list-style-type: none"> <li>• SBTS - Buitinė sutartis;</li> <li>• SKMS - Komercinė sutartis.</li> </ul>

No.	Attribute	type	obligation	description
17.	personName	string(200)	required	Contract owner name / company name.
18.	personSurname	string(50)	not required	Contract owner surname.
19.	personCode	string(20)	required	Person code.
20.	consumerCode	string(20)	required	Consumer code
21.	accessRightPhoneNo	string(12)	not required	Access right phone number.
22.	accessRightEmailAddress	string(100)	not required	Access right phone email address.
23.	accessRightNote	string(4000)	not required	Notes.

### 7.3.1.3 Error Response structure

The following table describes the JSON structure in the event of a response error:

No.	Attribute	type	obligation	description
1.	code	number	required	Error code.
2.	text	string(4000)	required	Error message.

### 7.3.2 POST /gateway/access-right

<b>URI</b>	POST /gateway/access-right		
<b>Description</b>	<p>The supplier can grant rights by himself to access clients' historical data if has client agreement.</p> <p>Using this API method, the vendor grants itself the right to access the historical data of the client objects on behalf of the customer. Once the rights have been granted, the supplier can download the customer's historical data for a certain period of time and, on that basis, offer the customer a contract.</p>		
<b>Parameters</b>	<b>URL:</b> The data of the JSON form request are presented in the HTTP request body (BODY) (Query JSON structure, below).		
<b>Header</b>	After decrypting the supplier authentication key, the supplier ID is used to select the data.		
<b>JSON request</b>	<pre>{   "consentSign":"boolean",   "personName":"string",   "personSurname":"string",   "personCode":"string",   "personBirthDate":"date",   "accessRightInformation":[     {       "objectNumber":"string",       "accessRightValidTo":"date",       "accessRightPhoneNo":"string",       "accessRightEmailAddress":"string",       "accessRightNote":"string"     }   ] }</pre>		
<b>Response HTTP code</b>	<b>HTTP status code</b>	<b>Reason</b>	<b>Description</b>
	200	OK	Request completed successfully
	400	Bad Request	Request error. The HTTP response body provides a list of errors in JSON format.

	401	Unauthorized	An attempt was made to connect to a non-public method that requires authentication, but no user credentials were provided.		
	403	Forbidden	According to the access control policy, the current user does not have access to perform the requested action.		
	404	Not Found	Either there is no API method associated with the request URL path, or the request contains one or more parameters that did not return the data.		
<b>JSON response</b>	[ { "accessRightId":"number" }]				
<b>JSON error response</b>	{ "errorMessages": [ { "code": 0, "text": "string" } ] }				
<b>Rules</b>	<b>No.</b>	<b>Rule description</b>	<b>Error code</b>	<b>Error message</b>	<b>Attributes</b>
	1.	The types of existing contracts for the objects must be the same.	3001	<a href="#">Access right assign</a> is not possible. Different contract types of objects.	objectNumber

2.	The attribute [objectNumber] is mandatory.	-	-	objectNumber
3.	The meaning of the [objectNumber] cannot be repeated.	7	The object: [objectNumber (if there is more than one object, objects must be separated by the semicolon)] is repeating.	objectNumber
	Must be specified valid object.	8	The object: [objectNumber (if there is more than one object, objects must be separated by the semicolon)] not found in the system.	objectNumber
	All objects specified in the request must belong to the owner specified in the request, the owner's contract must be valid and signed.	3007	The object: [objectNumber (if there is more than one object, objects must be separated by the semicolon)] does not belong to the specified owner / object does not have a valid contract.	personCode, personSurname, personName, personBirthDate, objectNumber
	The attribute [personBirthDate] format must be: yyyy-mm-dd. yyyy - year; mm - month; dd - day.	-	-	personBirthDate
	The attribute [personName] is mandatory.	-	-	personName
	The attributes [personSurname] and [personCode] or [personBirthDate] are mandatory if the object's existing contract type is SBTS.	3008	Person surname and personal code or date of birth are required if the contract type is SBTS.	personSurname, personCode, personBirthDate
	The attribute [personCode] is required if the object's existing contract type is SKMS.	3009	The company code must be provided if the contract type is SKMS.	personCode

	The attribute [accessRightValidTo] format must be: yyyy-mm-dd. yyyy - year; mm - month; dd - day.	-	-	accessRightValidTo
	The attribute [accessRightValidTo] can not be equal to the past date.	3003	Access right expire date can not be equal to the past date.	accessRightValidTo
	If the object of the existing contract type is SKMS, then the access right can be granted without restriction to the future.	-	-	accessRightValidTo
	If the object of the existing contract type is SBTS, then the maximum access right can be granted for one year, calculated from the current inclusive.	3004	If the contract type is SBTS, the maximum access right can be granted for one year.	accessRightValidTo
	The format of the attribute [accessRightPhoneNo] must be: +370XXXXXXXX, X - an integer (0 must be included).	3005	Phone no. incorrect format.	accessRightPhoneNo
	The format of the attribute [accessRightEmailAddress] must be [text][@][text][.domain], letters in the text must be Latin.	3006	Email address incorrect format.	accessRightEmailAddress
	If a record has been created for the interested party (independent	-	-	objectNumber

	supplier) and the object and person, it is updated, otherwise a new access right is inserted.			accessRightValidTo
	The meaning of the [consentSign] must be: <ul style="list-style-type: none"> <li>• True or</li> <li>• False.</li> </ul>	-	-	consentSign
	If the attribute [consentSign] = False, then the creation must be disabled.	3010	It is necessary to confirm that the data provided is correct and the consent of the owner of the object has been obtained.	consentSign

### 7.3.2.1 JSON Request structure

The table below describes the structure of the JSON request:

No.	Attribute	type	obligation	description
1.	consentSign	boolean	required	Consent sign.  I confirm that the consent of the specified person / company and / or legal basis to receive and process personal / company data has been obtained (person's name, surname / company name, person / company code, address, contact details, facility and electricity consumption data).
2.	personName	string(200)	required	Person name.
3.	personSurname	string(50)	not required	Person surname.
4.	personCode	string(20)	not required	Person code.

No.	Attribute	type	obligation	description
5	personBirthDate	date	not required	Person birth date.
accessRightInformation:[]				
6.	objectNumber	string(20)	required	Object number.
7.	accessRightValidTo	date	required	Access right valid date To.
8.	accessRightPhoneNo	string(12)	not required	Access right phone number.
9.	accessRightEmailAddress	string(100)	not required	Access right phone email address.
10.	accessRightNote	string(4000)	not required	Notes.

### 7.3.2.2 JSON Request structure

The table below describes the structure of the JSON response:

No.	Attribute	type	obligation	description
1.	accessRightId	number	required	Access right number (ID).

### 7.3.2.3 Error Response structure

The following table describes the JSON structure in the event of a response error:



No.	Attribute	type	obligation	description
1.	code	number	required	Error code.
2.	text	string(4000)	required	Error message.

### 7.3.3 POST /gateway/access-right/{accessRightUuid}/cancel

<b>URI</b>	POST /gateway/access-right/{accessRightId}/cancel		
<b>Description</b>	The supplier may remove the rights granted to him. He granted the rights himself with the client's permission, or the rights were granted to him by the client through ESO-S. The supplier can remove remove on rights which was granted by himself.		
<b>Parameters</b>	<b>URL:</b> <ul style="list-style-type: none"> <li>accessRightId - access right number (ID). Required</li> </ul>		
<b>Header</b>	After decrypting the supplier authentication key, the supplier ID is used to select the data.		
<b>JSON request</b>			
<b>Response HTTP code</b>	<b>HTTP status code</b>	<b>Reason</b>	<b>Description</b>
	200	OK	Request completed successfully
	204	No Content	No data found according to the given parameters.
	400	Bad Request	Request error. The HTTP response body provides a list of errors in JSON format.

	401	Unauthorized	An attempt was made to connect to a non-public method that requires authentication, but no user credentials were provided.		
	403	Forbidden	According to the access control policy, the current user does not have access to perform the requested action.		
	404	Not Found	Either there is no API method associated with the request URL path, or the request contains one or more parameters that did not return the data.		
	423	Locked	<p>The source or destination resource of a method is locked.</p> <p>This response SHOULD contain an appropriate precondition or postcondition code, such as 'lock-token-submitted' or 'no-conflicting-lock'.</p>		
<b>JSON response</b>					
<b>JSON error response</b>	<pre>{   "errorMessages":   [     {       "code": 0,       "text": "string"     }   ] }</pre>				
<b>Rules</b>	<b>No.</b>	<b>Rule description</b>	<b>Error code</b>	<b>Error message</b>	<b>Attributes</b>

	1.	It must be checked that the access right according to the provided accessRightId exists, is valid at the moment and is not revoked.	3011	The access right was not found in the system / it is not valid / is revoked / the right does not belong to the user initiating the action.	accessRightId
	2.	Upon successful revocation, a revocation sign must be affixed.	-	-	-

### 7.3.3.1 Error Response structure

The following table describes the JSON structure in the event of a response error:

No.	Attribute	type	obligation	description
1.	code	number	required	Error code.
2.	text	string(4000)	required	Error message.

## 7.4 Data order controller

### 7.4.1 POST /v2/data/data-orders

<b>URI</b>	POST /v2/data/data-orders
<b>Description</b>	The supplier can request the customer's historical object consumption data, which can consist of 4 files (objektai<...>.csv, suminiai<...>.csv, valandiniai<...>.csv ir sutikimai<...>.csv)
<b>Parameters</b>	none
<b>Request Body</b>	Data order must be submitted in HTTP request body in a form of JSON

<b>Response</b>	<b>HTTP status code</b>	<b>Reason</b>	<b>Response description</b>
	201	Created	Request completed successfully
	400	Bad Request	Request error. The HTTP response body provides a list of errors in JSON format.
	401	Unauthorized	An attempt was made to connect to a non-public method that requires authentication, but no user credentials were provided.
	403	Forbidden	According to the access control policy, the current user does not have access to perform the requested action.
	404	Not Found	Either there is no API method associated with the request URL path, or the request contains one or more parameters that did not return the data.
<b>Rules</b>	<b>No.</b>	<b>Rule description</b>	<b>Attributes</b>
	0.	If an attribute has defined possible values, the value index can be specified by specifying the value of the attribute in the request. Indices of all possible values start from 0.	All attributes with specified values.
	1.	Supplier can get historical client information, only if has client permission and the object of the client has a valid contract in the DSO Billing system.	-
	2.	Historical client information cannot be older than 36 months old.	<b>periodStart</b>
	3.	The supplier may not adduce the same object code more than once when ordering historical data.	<b>object code</b>
	4.	A supplier can include all objects into the data orders but only those objects which were not included in the previous data orders and no more than 100 objects per data order. If all suppliers' objects were included in the previous data orders the error message 11 will be displayed.	<b>includeAllObjects</b>

### 7.4.1.1 JSON Request structure

#### JSON Request structure

```
{
  "includeAllObjects": true,
  "includeHourlyReadings": true,
  "includeSummaryReadings": true,
  "objects": [
    {
      "code": "string",
      "consumerCode": "string"
    }
  ],
  "periodEnd": "2020-02-05",
  "periodStart": "2020-02-05"
}
```

Attribute	type	obligation	description
<b>includeAllObjects</b>	boolean	required	All objects data processing indicator:  value <b>true</b> means that all objects which were not included in previous data orders and that were granted to the supplier at the moment of submission of order should be involved in data order processing; value <b>false</b> means that only objects that are explicitly listed in data order (see element <b>Objects</b> , below) should be involved in data order processing.
<b>includeHourlyReadings</b>	boolean	required	Hourly readings indicator: value <b>true</b> means that hourly readings should be included in resulting data set; value <b>false</b> means that hourly readings should be omitted. Default value is <b>false</b> .
<b>includeSummaryReadings</b>	boolean	required	Summary (monthly) readings indicator: value <b>true</b> means that summary (monthly) readings should be included in resulting data set; value <b>false</b> means that summary (monthly) readings should be omitted. Default value is <b>true</b> .
<b>objects[]</b>	List	required	A list of objects that should be involved in data order processing. <b>Note:</b> supplier should have a valid permission to retrieve specified object data at the moment of data order submission. Otherwise DataHub Gateway will reject data order and issue an appropriate error message.

			Required only in case <b>allObjectsInd</b> attribute (see above) value is <b>false</b> . The element must contain one or more <b>Object</b> elements
<b>objects[].code</b>	string(20)	required	ESO issued object code.
<b>objects[].consumerCode</b>	string(32)	required	ESO issued consumer code of the client owning an object.
<b>periodEnd</b>	date	required	The end date of the period for which electricity consumption data needs to be collected in a format <b>YYYY-MM-DD</b> , where <b>YYYY</b> – year, <b>MM</b> – month, <b>DD</b> – day (i.e. 2020-12-01, 2021-01-01). <b>Note:</b> during data order processing, the period end date specified is always adjusted to the last day of month.
<b>periodStart</b>	date	required	The start date of the period for which electricity consumption data needs to be collected in a format <b>YYYY-MM-DD</b> , where <b>YYYY</b> – year, <b>MM</b> – month, <b>DD</b> – day (i.e. 2019-12-01, 2020-01-01). <b>Note:</b> during data order processing, the period start date is always truncated to the first day of month.

#### 7.4.1.2 JSON Response structure

##### JSON Response structure

```
{
  "completed": "2022-02-22T07:09:46.910Z",
  "id": 0,
  "inclHourlyReadings": true,
  "inclSummaryReadings": true,
  "periodEnd": "2022-02-22T07:09:46.910Z",
  "periodStart": "2022-02-22T07:09:46.910Z",
  "submitted": "2022-02-22T07:09:46.910Z"
}
```

Attribute	type	obligation	description
completed	timestamp	required	Date and time when the data order was completed
id	number	required	Data order identification number

inclHourlyReadings	boolean	required	Hourly readings indicator: value <b>true</b> means that hourly readings is included in resulting data set; value <b>false</b> means that hourly readings is omitted. Default value is <b>false</b> .
includeSummaryReadings	boolean	required	Summary (monthly) readings indicator: value true means that summary (monthly) readings is included in resulting data set; value false means that summary (monthly) readings is omitted. Default value is true.
periodEnd	date	required	The end date of the period for which electricity consumption data will be collected in a format YYYY-MM-DD, where YYYY – year, MM – month, DD – day (i.e. 2020-12-01, 2021-01-01). Note: during data order processing, the period end date specified is always adjusted to the last day of month.
periodStart	date	required	The start date of the period for which electricity consumption data will be collected in a format YYYY-MM-DD, where YYYY – year, MM – month, DD – day (i.e. 2019-12-01, 2020-01-01). Note: during data order processing, the period start date is always truncated to the first day of month.
submitted	timestamp	required	The date and time when the data order was submitted

#### 7.4.1.3 Response Error codes

Below are the error codes and messages. Response codes and response content in case of error:

Code	Message	Explanation
1	Required parameter <b>includeAllObjects</b> not specified.	Required parameter <b>includeAllObjects</b> must be included in request.
2	Required parameter <b>includeHourlyReadings</b> not specified.	Required parameter <b>includeHourlyReadings</b> must be included in request.
3	Required parameter <b>includeSummaryReadings</b> not specified.	Required parameter <b>includeSummaryReadings</b> must be included in request.
4	Required parameters <b>object code</b> and <b>consumer code</b> not specified.	When <b>includeAllObjects</b> is false, then object code and user code must be specified
5	Object not found by <b>object code</b> and <b>customer code</b> or object does not have a valid DSO contract and access rights.	Object was not found in the DataHub or you do not have rights to this object, or the object does not have a valid contract in the Billing system. Please check provided information.
6	<b>PeriodStart</b> date must be less than <b>periodEnd</b> date.	Period date range is incorrectly specified.
7	<b>PeriodStart</b> date must be less than today.	<b>PeriodStart</b> date is incorrectly specified.

Code	Message	Explanation
8	The maximum number of objects in one request is 100.	Request can contain a maximum of 100 objects.
9	<b>PeriodStart</b> date cannot be older than 36 months old.	<b>PeriodStart</b> date is too old.
10	The <b>object code</b> cannot be repeated in the same historical data order.	The <b>object code</b> cannot be repeated multiple times in the same historical data order.
11	All objects were included in the previous data orders.	If <b>includeAllObjects</b> is True and the all supplier objects were included in the previous data orders. There are no objects to include.

#### 7.4.2 GET /data/data-orders/{orderId}/data

<b>URI</b>	GET /data/data-orders/{orderId}/data		
<b>Description</b>	When calling POST /v2/data/data-orders method, supplier get response with <i>orderId</i> which is used calling GET /data/data-orders/{orderId}/data method to download historical clients consumption data, objects information and consents in ZIP file format.		
<b>Parameters</b>	orderId - unique data order identifier which is provided calling POST /v2/data/data-orders method.		
<b>Request Body</b>	none		
<b>Response</b>	<b>HTTP status code</b>	<b>Reason</b>	<b>Response description</b>
	200	Created	request successfully processed. HTTP response body contains ZIP format file containing collected data (see Contents of ZIP archive, below).
	204	No Content	No data found according to the given parameters.
	400	Bad Request	Request error. The HTTP response body provides a list of errors in JSON format.



	401	Unauthorized	An attempt was made to connect to a non-public method that requires authentication, but no user credentials were provided.
	403	Forbidden	According to the access control policy, the current user does not have access to perform the requested action.
	404	Not Found	Either there is no API method associated with the request URL path, or the request contains one or more parameters that did not return the data.
<b>Rules</b>	<b>No.</b>	<b>Rule description</b>	<b>Attributes</b>
	1.	before calling this method, Supplier has to be already called POST /v2/data/data-orders method, which returns orderId.	orderId

#### 7.4.2.1 JSON Request structure

JSON Request structure			
BODY - none			
URL - orderId			
Attribute	type	obligation	description
orderId (URL)	number(10)	required	URL attribute which is required. (info)This attribute value supplier gets calling POST /v2/data/data-orders method.

#### 7.4.2.2 JSON Response structure

HTTP response body contains ZIP format file containing collected data (see <i>Contents of ZIP archive</i> , below).			
Attribute	type	obligation	description
-	-	-	-

### 7.4.2.3 Contents of ZIP archive

- **Objektai <order id> [<period start> - <period end>] <timestamp>.csv** – general information on objects listed in data order and referenced in files **Suminiai <...>.csv** ir **Valandiniai <...>.csv** (see below), in CSV format.
- **Suminiai <order id> [<period start> - <period end>] <timestamp>.csv** – summary (monthly) electricity consumption data, in CSV format. File is provided only in case summary (monthly) electricity consumption data is requested when submitting data order (see description of **inclSummaryReadings** data order attribute).
- **Valandiniai <order number> [<period start> - <period end>] <timestamp>.csv** – hourly electricity consumption data, in CSV format. File is provided only in case hourly electricity consumption data is requested when submitting data order (see description of **inclHourlyReadings** data order attribute).
- **Sutikimai <order number> [<period start> - <period end>] <timestamp>.csv** - file containing clients' consents giving supplier a limited right to process clients' data and conduct direct marketing – submit to clients commercial proposals on electricity supply. Consents are provided only in case the client is household person on one line per client basis.

The following is a list of markups used in above mentioned file names:

- **<order id>** – unique data order identifier (i.e., 1234569, 984785, etc.)
- **<period start>** – the start date of the period for which the electricity consumption data must be collected, truncated to months (i.e. 2018-09, 2018-10, etc.)
- **<period end>** – the end date of the period for which the electricity consumption data must be collected, truncated to months (i.e. 2019-11, 2019-12, etc.)
- **<timestamp>** – date and data time data order processing started (i.e., 2019-10-30 22:55:45, 2020-01-01 23:15:01, etc.)

The first field (**Objekto Numeris**) in each CSV file contains unique ESO issued object number which should be used to establish relationships between data rows in CSV files (see figure below):

All CSV files included in ZIP archive adheres the following rules:

1. The very first line of the file provides data record field headers. Data records follow header line.
2. In order to ensure compatibility with Microsoft Excel, both field headers and field values are separated by semicolons (ASCII decimal code 59).
3. Comma symbol (ASCII decimal code 44) is used as decimal point separator in number values.
4. The contents of CSV files are provided in UTF-8. The first three bytes of the file are reserved for Byte Order Mark.

#### 7.4.2.3.1 File Objektai <...>.csv

The following table describes the structure of Objektai <...>.csv file:

No	Field Name	ANSI SQL Data Type	Description
1	Objekto numeris / Object Number	VARCHAR(20)	ESO issued unique object number.

No	Field Name	ANSI SQL Data Type	Description
2	Kliento įmonės kodas / Client Company Code	VARCHAR(20)	The registry code of client company owning the object.
3	Kliento pavadinimas . Client Name	VARCHAR(200)	The name of client company or, in case client is natural person, – client’s first and last names (space separated).
4	Objekto pavadinimas / Object Name	VARCHAR(200)	Object name.
5	Objekto tipas / Object Type	VARCHAR(200)	Object type.
6	Objekto adresas / Object Address	VARCHAR(4000)	Object address.
7	Leistinoji galia (kW) / Permitted Power (kW)	DECIMAL(10,3)	Permitted electrical power on object site, kW.
8	Viso skaitiklių / Total Number of Meters	DECIMAL(3)	Total number of electricity meters installed on object site.
9	Automatizuotų skaitiklių / Total Number of Smart Meters	DECIMAL(3)	Total number of smart electricity meters installed on object site.
10	Automatizacijos lygmuo / Automation Level	VARCHAR(7)	Electricity consumption accounting automation level on object site. Allowable field values are as follows:  Nėra (none) – object site has no smart meters installed. Dalinis (partial) – part of meters installed on object site are smart meters. Pilnas (full) – all meters installed on object site are smart meters.
11	Tarifo planas / Tariff plan	VARCHAR(255)	Tariff plan which is used at this moment by client
12	Galima tarifo plano keitimo data / Possible date of tariff plan change	TIMESTAMP	Date which describes when client can change his tariff plan at ESO
13	Įtampa / Voltage	FLOAT8	Voltage in client's object
14	Telefonas / Phone	VARCHAR(128)	Client contact phone number for communicating the details of commercial proposal.
15	El. pašto adresas / Email Address	VARCHAR(128)	Client contact email address for communicating the details of commercial proposal.

No	Field Name	ANSI SQL Data Type	Description
16	Pastabos / Notes	VARCHAR(4000)	Additional client information the supplier should consider while preparing the commercial proposal.
17	Teisė galioja iki / Access Rights Valid To	DATE	Date the permission to access object site's consumption data expires.  Field value format: YYYY-MM-DD, where:  YYYY – year, MM – month, DD – day  (i.e., 2019-10-30, 2020-01-01, etc.).
18	Paskutinį kartą duomenys gauti / Last Time Data Downloaded	TIMESTAMP	Last date and time the supplier downloaded object site's consumption data.  Field value format: YYYY-MM-DD HH:MI:SS, where:  YYYY – year, MM – month, DD – day, HH – hour (in 24 hours system), MI – minutes, SS – seconds  (i.e. 2019-10-30 23:59:01, 2020-01-01 11:05:59, etc.).

#### 7.4.2.3.2 File Suminiai <...>.csv

The following table describes the structure of **Suminiai <...>.csv** file:

No	Field Name	ANSI SQL Data Type	Description
1	Objekto numeris / Object Number	VARCHAR(20)	ESO issued unique object number.
2	Priskaitymo periodas / Accounting Period	DATE	Accounting month the amount of consumed electricity is allocated to.  Field value format: <b>YYYY-MM</b> , where:

No	Field Name	ANSI SQL Data Type	Description
			<b>YYYY</b> – year, <b>MM</b> – month.
3	VK	DECIMAL(12,2)	Amount of consumed single-priced electricity, kWh.
4	DD	DECIMAL(12,2)	Amount of consumed day-time electricity, kWh.
5	NK	DECIMAL(12,2)	Amount of consumed night-time and weekend electricity, kWh.
6	MA	DECIMAL(12,2)	Amount of consumed peak-load electricity, kWh.
7	VD	DECIMAL(12,2)	Amount of consumed average-load electricity, kWh.
8	SV	DECIMAL(12,2)	Amount of electricity consumed during holidays and day offs, kWh.
9	MI	DECIMAL(12,2)	Amount of consumed minimum-load electricity, kWh.
12	D1	DECIMAL(12,2)	Amount of consumed day electricity, kWh.
13	N1	DECIMAL(12,2)	Amount of consumed night electricity, kWh.
14	D2	DECIMAL(12,2)	Amount of consumed evening electricity, kWh.
15	N2	DECIMAL(12,2)	Amount of consumed morning electricity, kWh.
10	RV	DECIMAL(12,2)	Amount of consumed reactive electricity, kWh.
11	RG	DECIMAL(12,2)	Amount of generated reactive electricity, kWh.
16	Aktyvioji vartojama energija kiekis, kWh/ Amount of active energy consumed, kWh	DECIMAL(12,2)	Total amount of consumed electricity, kWh.

#### 7.4.2.3.3 File Valandiniai <...>.csv

The following table describes the structure of **Valandiniai <...>.csv** file:

No	Field Name	ANSI SQL Data Type	Description
1	Objekto numeris / Object Number	VARCHAR(20)	ESO issued unique object number.
2	Data, valanda / Date, Hour	VARCHAR(13)	Date and hour the readings were taken. Field value format: <b>YYYY-MM-DD HH</b> , where:  <b>YYYY</b> – year, <b>MM</b> – month, <b>DD</b> – day, <b>HH</b> – hour (in 24-hour system)  (i.e. 2019-10-30 13, 2020-01-01 23, etc.).
3	Energijos tipas / Energy Type	VARCHAR(2)	Type of electricity consumed / generated. Allowable field values are as follows:  <b>P+</b> – active P+ energy <b>P-</b> – active P- energy <b>Q+</b> – reactive Q+ energy <b>Q-</b> – reactive Q- energy  <b>Note:</b> this software version provides active P+ and P- energy consumption data.
4	Kiekis, kWh / Amount, kWh	DECIMAL(13,3)	Amount of electricity consumed, or generated kWh.

#### 7.4.2.3.4 File Sutikimai <...>.csv

The following table describes the structure of **Valandiniai <...>.csv** file:

No	Field Name	ANSI SQL Data Type	Description
1	KLIENTO_PAVADINIMAS/ CLIENT_NAME	VARCHAR(200)	Client name and surname (if household client), company name (if legal client) who gives consent
2	DATA/ DATE	VARCHAR(10)	Date when consent was given Field value format: <b>YYYY-MM-DD</b> , where:  <b>YYYY</b> – year,

No	Field Name	ANSI SQL Data Type	Description
			<b>MM</b> – month, <b>DD</b> – day,  (i.e. 2019-10-30, 2020-01-01, etc.).
3	SUTIKIMAS / CONSENT	VARCHAR(5000)	Consent content  <b>i Note:</b> earlier consent was in PDF format (one PDF per client), now all consent data will be provided in Sutikimai<...>.csv file (one line per client).

Below are the error codes and messages. Response codes and response content in case of error:

#### 7.4.2.4 Response Error codes

Code	Message	Explanation
1	<b>OrderId</b> must be number.	Incorrect parameter data types.
2	Order could not be found.	Order was not found in the DataHub or the order belongs to another supplier. Please check provided information.
3	Request is being processed.	Data is still being prepared.

#### Response example in case of error

```
{
  "errorMessages": [
    {
      "code": 0,
      "text": "string"
    }
  ],
  "orderId": null
}
```

## 7.5 Report controller

### Old methods of the reports

### 7.5.1 POST /reports/accounting-data-pack-b2c?first={integer}&count={integer}

<b>URI</b>	POST /reports/accounting-data-pack-b2c?first={integer}&count={integer}		
<b>Description</b>	Report which will return accounting data in meters level for Household customers. If household client object has two meters, this method will return list of two items.		
<b>Parameters</b>	<p>URL parameters:</p> <p>first - the index of the report line, which must be the first in the return list (starting from 0). Optional. The default value is 0.</p> <p>count - the number of report rows in the return list. Optional. The default value is 30.</p>		
<b>Request Body</b>	Data order must be submitted in HTTP request body in a form of JSON		
<b>Response</b>	<b>HTTP status code</b>	<b>Reason</b>	<b>Response description</b>
	201	Created	Request completed successfully
	400	Bad Request	Request error. The HTTP response body provides a list of errors in JSON format.
	401	Unauthorized	An attempt was made to connect to a non-public method that requires authentication, but no user credentials were provided.
	403	Forbidden	According to the access control policy, the current user does not have access to perform the requested action.
	404	Not Found	Either there is no API method associated with the request URL path, or the request contains one or more parameters that did not return the data.
	423	Locked	The source or destination resource of a method is locked.



Rules	No.	Rule description	Attributes
			This response SHOULD contain an appropriate precondition or postcondition code, such as 'lock-token-submitted' or 'no-conflicting-lock'.
	0.	If an attribute has defined possible values, the value index can be specified by specifying the value of the attribute in the request. Indices of all possible values start from 0.	All attributes with specified values.
	1.	The value of the count parameter cannot be above 10 000. If the error occurs the error message 1004 will be displayed.	count
	2.	Depending on the dateFrom and dateTo fields specified in the request, the request is executed and the report data is selected and submitted. If only date fields are specified, then the report returns information about all objects in all customer contracts.	dateFrom, dateTo
	3.	Depending on the dateFrom and dateTo fields specified in the request, the request is executed and the report data is selected and submitted. If date fields and customerCode are specified, then the report returns information about all objects in provided customer contract.	dateFrom, dateTo, customerCode
	4.	Depending on the dateFrom and dateTo fields specified in the request, the request is executed and the report data is selected and submitted. If date fields, customerCode and objectNo are specified, then the report returns information about provided object in provided customer contract.	dateFrom, dateTo, customerCode, objectNo
	5.	The operator does not provide interim data. The operator provides only final / complete data.	-

### 7.5.1.1 JSON Request structure

JSON Request structure

```
{
"customerCode": "string",
"dateFrom": "date",
"dateTo": "date",
```

```
"objectNo": "string"
}
```

Attribute	type	obligation	description
customerCode	String(32)	not required	User code of contracted customer
dateFrom	Date	required	Date from which data from DSO Billing system should be included into report
dateTo	Date	required	Date to which data from DSO Billing system should be included into report
objectNo	String(20)	not required	Object Number of the object for the supply of electricity in which the contract is concluded.

The table below describes URL request attributes:

Attribute	type	obligation	description
<b>first</b>	integer	not required	Index (starting from 0) of the object that must be presented first in the return list.
<b>count</b>	integer	not required	Number of objects in the return list.

### 7.5.1.2 JSON Response structure

JSON Response structure

```
[
{
"CustomerID": "string",
"ClientID": "string",
"ClientName": "string",
"ClientAddress": "string",
"ObjectID": 0,
"ObjectNumber": "string",
"ObjectName": "string",
"ObjectType": "string",
"GeneratingCustomer": true,
"ObjectAddress": "string",
"AgreementType": "string",
"AgreementModel": "string",
```

"AgreementFrom": "2020-09-21",  
"AgreementTo": "2020-09-21",  
"PermittablePowerConsumption": 0,  
"PermittablePowerGeneration": 0,  
"InstalledGeneratingPower": 0,  
"InstalledConsumptionPower": 0,  
"MetersAmount": 0,  
"AutoMetersAmount": 0,  
"ReportingPeriod": "2020-09-21",  
"BillingPeriod": "2020-09-21",  
"SupplyState": "string",  
"SupplyStateFrom": "2020-09-21",  
"SupplyStateTo": "2020-09-21",  
"MetersNumber": "string",  
"ReadingsSource": "string",  
"ReadingsReceiveDate": "2020-09-21",  
"PaymentType": "string",  
"Service": "string",  
"DeclarationReferenceType": "string",  
"ReferenceSubmitDate": "2020-09-21",  
"ReadingsSubmitDate": "2020-09-21",  
"DeclarationReferenceNumber": 0,  
"UnaccountedConsumptionActNumber": 0,  
"UnaccountedConsumptionActCreateDate": "2020-09-21",  
"UnaccountedConsumptionActFrom": "2020-09-21",  
"UnaccountedConsumptionActTo": "2020-09-21",  
"ConsumptionConversionActNumber": "string",  
"ConsumptionConversionActCreateDate": "2020-09-21",  
"ConsumptionConversionActFrom": "2020-09-21",  
"ConsumptionConversionActTo": "2020-09-21",  
"ConsumptionState": "string",  
"ConsumptionStateFrom": "2020-09-21",  
"ConsumptionStateTo": "2020-09-21",  
"TariffPlan": "string",  
"TariffPlanChangeDate": "2020-09-21",  
"ConsumptionConversionAct": true,  
"PowerPlantCapacityDateFrom": "2020-09-21",  
"EnergyObtainedDateFrom": "2020-09-21",  
"PowerPlantCapacityDateTo": "2020-09-21",  
"EnergyObtainedDateTo": "2020-09-21",  
"EnergyObtainedPowerKw": 0,  
"OperatorGridElectricityPercent": 0,

"ClientGridElectricityPercent": 0,  
"VkConsumptionAmount": 0,  
"VkViapConsumptionAmount": 0,  
"VkSppdConsumptionAmount": 0,  
"DdConsumptionAmount": 0,  
"DdViapConsumptionAmount": 0,  
"DdSppdConsumptionAmount": 0,  
"NkConsumptionAmount": 0,  
"NkViapConsumptionAmount": 0,  
"NkSppdConsumptionAmount": 0,  
"N2ConsumptionAmount": 0,  
"N2ViapConsumptionAmount": 0,  
"N2SppdConsumptionAmount": 0,  
"D1ConsumptionAmount": 0,  
"D1ViapConsumptionAmount": 0,  
"D1SppdConsumptionAmount": 0,  
"D2ConsumptionAmount": 0,  
"D2ViapConsumptionAmount": 0,  
"D2SppdConsumptionAmount": 0,  
"N1ConsumptionAmount": 0,  
"N1ViapConsumptionAmount": 0,  
"N1SppdConsumptionAmount": 0,  
"VkConsumedElectricityConsumptionAmount": 0,  
"DdConsumedElectricityConsumptionAmount": 0,  
"NkConsumedElectricityConsumptionAmount": 0,  
"N2ConsumedElectricityConsumptionAmount": 0,  
"D1ConsumedElectricityConsumptionAmount": 0,  
"D2ConsumedElectricityConsumptionAmount": 0,  
"N1ConsumedElectricityConsumptionAmount": 0,  
"VkPayingRecoveredEnergyConsumptionAmount": 0,  
"DdPayingRecoveredEnergyConsumptionAmount": 0,  
"NkPayingRecoveredEnergyConsumptionAmount": 0,  
"N2PayingRecoveredEnergyConsumptionAmount": 0,  
"D1PayingRecoveredEnergyConsumptionAmount": 0,  
"D2PayingRecoveredEnergyConsumptionAmount": 0,  
"N1PayingRecoveredEnergyConsumptionAmount": 0,  
"VkPayingRecoveredPercentConsumptionAmount": 0,  
"DdPayingRecoveredPercentConsumptionAmount": 0,  
"NkPayingRecoveredPercentConsumptionAmount": 0,  
"N2PayingRecoveredPercentConsumptionAmount": 0,  
"D1PayingRecoveredPercentConsumptionAmount": 0,  
"D2PayingRecoveredPercentConsumptionAmount": 0,

"N1PayingRecoveredPercentConsumptionAmount": 0,  
"VkPayingRecoveredPowerConsumptionAmount": 0,  
"DdPayingRecoveredPowerConsumptionAmount": 0,  
"NkPayingRecoveredPowerConsumptionAmount": 0,  
"N2PayingRecoveredPowerConsumptionAmount": 0,  
"D1PayingRecoveredPowerConsumptionAmount": 0,  
"D2PayingRecoveredPowerConsumptionAmount": 0,  
"N1PayingRecoveredPowerConsumptionAmount": 0,  
"VkPayingRecoveredMixedConsumptionAmount": 0,  
"DdPayingRecoveredMixedConsumptionAmount": 0,  
"NkPayingRecoveredMixedConsumptionAmount": 0,  
"N2PayingRecoveredMixedConsumptionAmount": 0,  
"D1PayingRecoveredMixedConsumptionAmount": 0,  
"D2PayingRecoveredMixedConsumptionAmount": 0,  
"N1PayingRecoveredMixedConsumptionAmount": 0,  
"VkMissingEnergyConsumptionAmount": 0,  
"VkMissingEnergyViapConsumptionAmount": 0,  
"VkMissingEnergySppdConsumptionAmount": 0,  
"DdMissingEnergyConsumptionAmount": 0,  
"DdMissingEnergyViapConsumptionAmount": 0,  
"DdMissingEnergySppdConsumptionAmount": 0,  
"NkMissingEnergyConsumptionAmount": 0,  
"NkMissingEnergyViapConsumptionAmount": 0,  
"NkMissingEnergySppdConsumptionAmount": 0,  
"N2MissingEnergyConsumptionAmount": 0,  
"N2MissingEnergyViapConsumptionAmount": 0,  
"N2MissingEnergySppdConsumptionAmount": 0,  
"D1MissingEnergyConsumptionAmount": 0,  
"D1MissingEnergyViapConsumptionAmount": 0,  
"D1MissingEnergySppdConsumptionAmount": 0,  
"D2MissingEnergyConsumptionAmount": 0,  
"D2MissingEnergyViapConsumptionAmount": 0,  
"D2MissingEnergySppdConsumptionAmount": 0,  
"N1MissingEnergyConsumptionAmount": 0,  
"N1MissingEnergyViapConsumptionAmount": 0,  
"N1MissingEnergySppdConsumptionAmount": 0,  
"GridSuppliedConsumptionAmount": 0,  
"AccumulatedBeginningConsumptionAmount": 0,  
"AccumulatedEndConsumptionAmount": 0,  
"AccumulatedTransferredConsumptionAmount": 0,  
"AccumulatedUploadedConsumptionAmount": 0,  
"AccumulatedRaisedConsumptionAmount": 0,

"CompensatedConsumptionAmount": 0,  
"OldIndependentSupplier": "string",  
"PowerPlantCapacityConsumptionAmount": 0,  
"EnergyObtainedConsumptionAmount": 0,  
"OperatorGridElectricityConsumptionAmount": 0,  
"ClientGridElectricityConsumptionAmount": 0,  
"VkUnit": "string",  
"VkViapUnit": "string",  
"VkSppdUnit": "string",  
"DdUnit": "string",  
"DdViapUnit": "string",  
"DdSppdUnit": "string",  
"NkUnit": "string",  
"NkViapUnit": "string",  
"NkSppdUnit": "string",  
"N2Unit": "string",  
"N2ViapUnit": "string",  
"N2SppdUnit": "string",  
"D1Unit": "string",  
"D1ViapUnit": "string",  
"D1SppdUnit": "string",  
"D2Unit": "string",  
"D2ViapUnit": "string",  
"D2SppdUnit": "string",  
"N1Unit": "string",  
"N1ViapUnit": "string",  
"N1SppdUnit": "string",  
"VkConsumedElectricityUnit": "string",  
"DdConsumedElectricityUnit": "string",  
"NkConsumedElectricityUnit": "string",  
"N2ConsumedElectricityUnit": "string",  
"D1ConsumedElectricityUnit": "string",  
"D2ConsumedElectricityUnit": "string",  
"N1ConsumedElectricityUnit": "string",  
"VkPayingRecoveredEnergyUnit": "string",  
"DdPayingRecoveredEnergyUnit": "string",  
"NkPayingRecoveredEnergyUnit": "string",  
"N2PayingRecoveredEnergyUnit": "string",  
"D1PayingRecoveredEnergyUnit": "string",  
"D2PayingRecoveredEnergyUnit": "string",  
"N1PayingRecoveredEnergyUnit": "string",  
"VkPayingRecoveredPercentUnit": "string",

"DdPayingRecoveredPercentUnit": "string",  
"NkPayingRecoveredPercentUnit": "string",  
"N2PayingRecoveredPercentUnit": "string",  
"D1PayingRecoveredPercentUnit": "string",  
"D2PayingRecoveredPercentUnit": "string",  
"N1PayingRecoveredPercentUnit": "string",  
"VkPayingRecoveredPowerUnit": "string",  
"DdPayingRecoveredPowerUnit": "string",  
"NkPayingRecoveredPowerUnit": "string",  
"N2PayingRecoveredPowerUnit": "string",  
"D1PayingRecoveredPowerUnit": "string",  
"D2PayingRecoveredPowerUnit": "string",  
"N1PayingRecoveredPowerUnit": "string",  
"VkPayingRecoveredMixedUnit": "string",  
"DdPayingRecoveredMixedUnit": "string",  
"NkPayingRecoveredMixedUnit": "string",  
"N2PayingRecoveredMixedUnit": "string",  
"D1PayingRecoveredMixedUnit": "string",  
"D2PayingRecoveredMixedUnit": "string",  
"N1PayingRecoveredMixedUnit": "string",  
"VkMissingEnergyUnit": "string",  
"VkMissingEnergyViapUnit": "string",  
"VkMissingEnergySppdUnit": "string",  
"DdMissingEnergyUnit": "string",  
"DdMissingEnergyViapUnit": "string",  
"DdMissingEnergySppdUnit": "string",  
"NkMissingEnergyUnit": "string",  
"NkMissingEnergyViapUnit": "string",  
"NkMissingEnergySppdUnit": "string",  
"N2MissingEnergyUnit": "string",  
"N2MissingEnergyViapUnit": "string",  
"N2MissingEnergySppdUnit": "string",  
"D1MissingEnergyUnit": "string",  
"D1MissingEnergyViapUnit": "string",  
"D1MissingEnergySppdUnit": "string",  
"D2MissingEnergyUnit": "string",  
"D2MissingEnergyViapUnit": "string",  
"D2MissingEnergySppdUnit": "string",  
"N1MissingEnergyUnit": "string",  
"N1MissingEnergyViapUnit": "string",  
"N1MissingEnergySppdUnit": "string",  
"VkReadingsFrom": 0,

"DdReadingsFrom": 0,  
"NkReadingsFrom": 0,  
"N2ReadingsFrom": 0,  
"D1ReadingsFrom": 0,  
"D2ReadingsFrom": 0,  
"N1ReadingsFrom": 0,  
"VkConsumedElectricityReadingsFrom": 0,  
"DdConsumedElectricityReadingsFrom": 0,  
"NkConsumedElectricityReadingsFrom": 0,  
"N2ConsumedElectricityReadingsFrom": 0,  
"D1ConsumedElectricityReadingsFrom": 0,  
"D2ConsumedElectricityReadingsFrom": 0,  
"N1ConsumedElectricityReadingsFrom": 0,  
"GridSuppliedReadingsFrom": 0,  
"VkReadingsTo": 0,  
"DdReadingsTo": 0,  
"NkReadingsTo": 0,  
"N2ReadingsTo": 0,  
"D1ReadingsTo": 0,  
"D2ReadingsTo": 0,  
"N1ReadingsTo": 0,  
"VkConsumedElectricityReadingsTo": 0,  
"DdConsumedElectricityReadingsTo": 0,  
"NkConsumedElectricityReadingsTo": 0,  
"N2ConsumedElectricityReadingsTo": 0,  
"D1ConsumedElectricityReadingsTo": 0,  
"D2ConsumedElectricityReadingsTo": 0,  
"N1ConsumedElectricityReadingsTo": 0,  
"GridSuppliedReadingsTo": 0,  
"VkPriceEur": 0,  
"VkViapPriceEur": 0,  
"VkSppdPriceEur": 0,  
"DdPriceEur": 0,  
"DdViapPriceEur": 0,  
"DdSppdPriceEur": 0,  
"NkPriceEur": 0,  
"NkViapPriceEur": 0,  
"NkSppdPriceEur": 0,  
"N2PriceEur": 0,  
"N2ViapPriceEur": 0,  
"N2SppdPriceEur": 0,  
"D1PriceEur": 0,



"D1ViapPriceEur": 0,  
"D1SppdPriceEur": 0,  
"D2PriceEur": 0,  
"D2ViapPriceEur": 0,  
"D2SppdPriceEur": 0,  
"N1PriceEur": 0,  
"N1ViapPriceEur": 0,  
"N1SppdPriceEur": 0,  
"VkPayingRecoveredEnergyPriceEur": 0,  
"DdPayingRecoveredEnergyPriceEur": 0,  
"NkPayingRecoveredEnergyPriceEur": 0,  
"N2PayingRecoveredEnergyPriceEur": 0,  
"D1PayingRecoveredEnergyPriceEur": 0,  
"D2PayingRecoveredEnergyPriceEur": 0,  
"N1PayingRecoveredEnergyPriceEur": 0,  
"VkPayingRecoveredMixedPriceEur": 0,  
"DdPayingRecoveredMixedPriceEur": 0,  
"NkPayingRecoveredMixedPriceEur": 0,  
"N2PayingRecoveredMixedPriceEur": 0,  
"D1PayingRecoveredMixedPriceEur": 0,  
"D2PayingRecoveredMixedPriceEur": 0,  
"N1PayingRecoveredMixedPriceEur": 0,  
"VkMissingEnergyPriceEur": 0,  
"VkMissingEnergyViapPriceEur": 0,  
"VkMissingEnergySppdPriceEur": 0,  
"DdMissingEnergyPriceEur": 0,  
"DdMissingEnergyViapPriceEur": 0,  
"DdMissingEnergySppdPriceEur": 0,  
"NkMissingEnergyPriceEur": 0,  
"NkMissingEnergyViapPriceEur": 0,  
"NkMissingEnergySppdPriceEur": 0,  
"N2MissingEnergyPriceEur": 0,  
"N2MissingEnergyViapPriceEur": 0,  
"N2MissingEnergySppdPriceEur": 0,  
"D1MissingEnergyPriceEur": 0,  
"D1MissingEnergyViapPriceEur": 0,  
"D1MissingEnergySppdPriceEur": 0,  
"D2MissingEnergyPriceEur": 0,  
"D2MissingEnergyViapPriceEur": 0,  
"D2MissingEnergySppdPriceEur": 0,  
"N1MissingEnergyPriceEur": 0,  
"N1MissingEnergyViapPriceEur": 0,

"N1MissingEnergySppdPriceEur": 0,  
"PowerPlantCapacityPriceEur": 0,  
"VkPriceEurVAT": 0,  
"VkViapPriceEurVAT": 0,  
"VkSppdPriceEurVAT": 0,  
"DdPriceEurVAT": 0,  
"DdViapPriceEurVAT": 0,  
"DdSppdPriceEurVAT": 0,  
"NkPriceEurVAT": 0,  
"NkViapPriceEurVAT": 0,  
"NkSppdPriceEurVAT": 0,  
"N2PriceEurVAT": 0,  
"N2ViapPriceEurVAT": 0,  
"N2SppdPriceEurVAT": 0,  
"D1PriceEurVAT": 0,  
"D1ViapPriceEurVAT": 0,  
"D1SppdPriceEurVAT": 0,  
"D2PriceEurVAT": 0,  
"D2ViapPriceEurVAT": 0,  
"D2SppdPriceEurVAT": 0,  
"N1PriceEurVAT": 0,  
"N1ViapPriceEurVAT": 0,  
"N1SppdPriceEurVAT": 0,  
"VkPayingRecoveredEnergyPriceEurVAT": 0,  
"DdPayingRecoveredEnergyPriceEurVAT": 0,  
"NkPayingRecoveredEnergyPriceEurVAT": 0,  
"N2PayingRecoveredEnergyPriceEurVAT": 0,  
"D1PayingRecoveredEnergyPriceEurVAT": 0,  
"D2PayingRecoveredEnergyPriceEurVAT": 0,  
"N1PayingRecoveredEnergyPriceEurVAT": 0,  
"VkPayingRecoveredMixedPriceEurVAT": 0,  
"DdPayingRecoveredMixedPriceEurVAT": 0,  
"NkPayingRecoveredMixedPriceEurVAT": 0,  
"N2PayingRecoveredMixedPriceEurVAT": 0,  
"D1PayingRecoveredMixedPriceEurVAT": 0,  
"D2PayingRecoveredMixedPriceEurVAT": 0,  
"N1PayingRecoveredMixedPriceEurVAT": 0,  
"VkMissingEnergyPriceEurVAT": 0,  
"VkMissingEnergyViapPriceEurVAT": 0,  
"VkMissingEnergySppdPriceEurVAT": 0,  
"DdMissingEnergyPriceEurVAT": 0,  
"DdMissingEnergyViapPriceEurVAT": 0,

"DdMissingEnergySppdPriceEurVAT": 0,  
"NkMissingEnergyPriceEurVAT": 0,  
"NkMissingEnergyViapPriceEurVAT": 0,  
"NkMissingEnergySppdPriceEurVAT": 0,  
"N2MissingEnergyPriceEurVAT": 0,  
"N2MissingEnergyViapPriceEurVAT": 0,  
"N2MissingEnergySppdPriceEurVAT": 0,  
"D1MissingEnergyPriceEurVAT": 0,  
"D1MissingEnergyViapPriceEurVAT": 0,  
"D1MissingEnergySppdPriceEurVAT": 0,  
"D2MissingEnergyPriceEurVAT": 0,  
"D2MissingEnergyViapPriceEurVAT": 0,  
"D2MissingEnergySppdPriceEurVAT": 0,  
"N1MissingEnergyPriceEurVAT": 0,  
"N1MissingEnergyViapPriceEurVAT": 0,  
"N1MissingEnergySppdPriceEurVAT": 0,  
"PowerPlantCapacityPriceEurVAT": 0,  
"VkDiscount": 0,  
"VkViapDiscount": 0,  
"VkSppdDiscount": 0,  
"DdDiscount": 0,  
"DdViapDiscount": 0,  
"DdSppdDiscount": 0,  
"NkDiscount": 0,  
"NkViapDiscount": 0,  
"NkSppdDiscount": 0,  
"N2Discount": 0,  
"N2ViapDiscount": 0,  
"N2SppdDiscount": 0,  
"D1Discount": 0,  
"D1ViapDiscount": 0,  
"D1SppdDiscount": 0,  
"D2Discount": 0,  
"D2ViapDiscount": 0,  
"D2SppdDiscount": 0,  
"N1Discount": 0,  
"N1ViapDiscount": 0,  
"N1SppdDiscount": 0,  
"VkPayingRecoveredEnergyDiscount": 0,  
"VkPayingRecoveredMixedDiscount": 0,  
"VkMissingEnergyDiscount": 0,  
"VkMissingEnergyViapDiscount": 0,

"VkMissingEnergySppdDiscount": 0,  
"FixedFeeAmountNoVAT": 0,  
"VkAmountNoVAT": 0,  
"VkViapAmountNoVAT": 0,  
"VkSppdAmountNoVAT": 0,  
"DdAmountNoVAT": 0,  
"DdViapAmountNoVAT": 0,  
"DdSppdAmountNoVAT": 0,  
"NkAmountNoVAT": 0,  
"NkViapAmountNoVAT": 0,  
"NkSppdAmountNoVAT": 0,  
"N2AmountNoVAT": 0,  
"N2ViapAmountNoVAT": 0,  
"N2SppdAmountNoVAT": 0,  
"D1AmountNoVAT": 0,  
"D1ViapAmountNoVAT": 0,  
"D1SppdAmountNoVAT": 0,  
"D2AmountNoVAT": 0,  
"D2ViapAmountNoVAT": 0,  
"D2SppdAmountNoVAT": 0,  
"N1AmountNoVAT": 0,  
"N1ViapAmountNoVAT": 0,  
"N1SppdAmountNoVAT": 0,  
"VkPayingRecoveredEnergyAmountNoVAT": 0,  
"DdPayingRecoveredEnergyAmountNoVAT": 0,  
"NkPayingRecoveredEnergyAmountNoVAT": 0,  
"N2PayingRecoveredEnergyAmountNoVAT": 0,  
"D1PayingRecoveredEnergyAmountNoVAT": 0,  
"D2PayingRecoveredEnergyAmountNoVAT": 0,  
"N1PayingRecoveredEnergyAmountNoVAT": 0,  
"VkPayingRecoveredMixedAmountNoVAT": 0,  
"DdPayingRecoveredMixedAmountNoVAT": 0,  
"NkPayingRecoveredMixedAmountNoVAT": 0,  
"N2PayingRecoveredMixedAmountNoVAT": 0,  
"D1PayingRecoveredMixedAmountNoVAT": 0,  
"D2PayingRecoveredMixedAmountNoVAT": 0,  
"N1PayingRecoveredMixedAmountNoVAT": 0,  
"VkMissingEnergyAmountNoVAT": 0,  
"VkMissingEnergyViapAmountNoVAT": 0,  
"VkMissingEnergySppdAmountNoVAT": 0,  
"DdMissingEnergyAmountNoVAT": 0,  
"DdMissingEnergyViapAmountNoVAT": 0,

"DdMissingEnergySppdAmountNoVAT": 0,  
"NkMissingEnergyAmountNoVAT": 0,  
"NkMissingEnergyViapAmountNoVAT": 0,  
"NkMissingEnergySppdAmountNoVAT": 0,  
"N2MissingEnergyAmountNoVAT": 0,  
"N2MissingEnergyViapAmountNoVAT": 0,  
"N2MissingEnergySppdAmountNoVAT": 0,  
"D1MissingEnergyAmountNoVAT": 0,  
"D1MissingEnergyViapAmountNoVAT": 0,  
"D1MissingEnergySppdAmountNoVAT": 0,  
"D2MissingEnergyAmountNoVAT": 0,  
"D2MissingEnergyViapAmountNoVAT": 0,  
"D2MissingEnergySppdAmountNoVAT": 0,  
"N1MissingEnergyAmountNoVAT": 0,  
"N1MissingEnergyViapAmountNoVAT": 0,  
"N1MissingEnergySppdAmountNoVAT": 0,  
"PowerPlantCapacityAmountNoVAT": 0,  
"FixedFeeAmount": 0,  
"VkAmount": 0,  
"VkViapAmount": 0,  
"VkSppdAmount": 0,  
"DdAmount": 0,  
"DdViapAmount": 0,  
"DdSppdAmount": 0,  
"NkAmount": 0,  
"NkViapAmount": 0,  
"NkSppdAmount": 0,  
"N2Amount": 0,  
"N2ViapAmount": 0,  
"N2SppdAmount": 0,  
"D1Amount": 0,  
"D1ViapAmount": 0,  
"D1SppdAmount": 0,  
"D2Amount": 0,  
"D2ViapAmount": 0,  
"D2SppdAmount": 0,  
"N1Amount": 0,  
"N1ViapAmount": 0,  
"N1SppdAmount": 0,  
"VkPayingRecoveredEnergyAmount": 0,  
"DdPayingRecoveredEnergyAmount": 0,  
"NkPayingRecoveredEnergyAmount": 0,

"N2PayingRecoveredEnergyAmount": 0,  
"D1PayingRecoveredEnergyAmount": 0,  
"D2PayingRecoveredEnergyAmount": 0,  
"N1PayingRecoveredEnergyAmount": 0,  
"VkPayingRecoveredMixedAmount": 0,  
"DdPayingRecoveredMixedAmount": 0,  
"NkPayingRecoveredMixedAmount": 0,  
"N2PayingRecoveredMixedAmount": 0,  
"D1PayingRecoveredMixedAmount": 0,  
"D2PayingRecoveredMixedAmount": 0,  
"N1PayingRecoveredMixedAmount": 0,  
"VkMissingEnergyAmount": 0,  
"VkMissingEnergyViapAmount": 0,  
"VkMissingEnergySppdAmount": 0,  
"DdMissingEnergyAmount": 0,  
"DdMissingEnergyViapAmount": 0,  
"DdMissingEnergySppdAmount": 0,  
"NkMissingEnergyAmount": 0,  
"NkMissingEnergyViapAmount": 0,  
"NkMissingEnergySppdAmount": 0,  
"N2MissingEnergyAmount": 0,  
"N2MissingEnergyViapAmount": 0,  
"N2MissingEnergySppdAmount": 0,  
"D1MissingEnergyAmount": 0,  
"D1MissingEnergyViapAmount": 0,  
"D1MissingEnergySppdAmount": 0,  
"D2MissingEnergyAmount": 0,  
"D2MissingEnergyViapAmount": 0,  
"D2MissingEnergySppdAmount": 0,  
"N1MissingEnergyAmount": 0,  
"N1MissingEnergyViapAmount": 0,  
"N1MissingEnergySppdAmount": 0,  
"PowerPlantCapacityAmount": 0,  
"FixedFeeIncludedVAT": "string",  
"VkIncludedVAT": "string",  
"VkViapIncludedVAT": "string",  
"VkSppdIncludedVAT": "string",  
"DdIncludedVAT": "string",  
"DdViapIncludedVAT": "string",  
"DdSppdIncludedVAT": "string",  
"NkIncludedVAT": "string",  
"NkViapIncludedVAT": "string",

"NkSppdIncludedVAT": "string",  
"N2IncludedVAT": "string",  
"N2ViapIncludedVAT": "string",  
"N2SppdIncludedVAT": "string",  
"D1IncludedVAT": "string",  
"D1ViapIncludedVAT": "string",  
"D1SppdIncludedVAT": "string",  
"D2IncludedVAT": "string",  
"D2ViapIncludedVAT": "string",  
"D2SppdIncludedVAT": "string",  
"N1IncludedVAT": "string",  
"N1ViapIncludedVAT": "string",  
"N1SppdIncludedVAT": "string",  
"VkPayingRecoveredEnergyIncludedVAT": "string",  
"DdPayingRecoveredEnergyIncludedVAT": "string",  
"NkPayingRecoveredEnergyIncludedVAT": "string",  
"N2PayingRecoveredEnergyIncludedVAT": "string",  
"D1PayingRecoveredEnergyIncludedVAT": "string",  
"D2PayingRecoveredEnergyIncludedVAT": "string",  
"N1PayingRecoveredEnergyIncludedVAT": "string",  
"VkPayingRecoveredMixedIncludedVAT": "string",  
"DdPayingRecoveredMixedIncludedVAT": "string",  
"NkPayingRecoveredMixedIncludedVAT": "string",  
"N2PayingRecoveredMixedIncludedVAT": "string",  
"D1PayingRecoveredMixedIncludedVAT": "string",  
"D2PayingRecoveredMixedIncludedVAT": "string",  
"N1PayingRecoveredMixedIncludedVAT": "string",  
"VkMissingEnergyIncludedVAT": "string",  
"VkMissingEnergyViapIncludedVAT": "string",  
"VkMissingEnergySppdIncludedVAT": "string",  
"DdMissingEnergyIncludedVAT": "string",  
"DdMissingEnergyViapIncludedVAT": "string",  
"DdMissingEnergySppdIncludedVAT": "string",  
"NkMissingEnergyIncludedVAT": "string",  
"NkMissingEnergyViapIncludedVAT": "string",  
"NkMissingEnergySppdIncludedVAT": "string",  
"N2MissingEnergyIncludedVAT": "string",  
"N2MissingEnergyViapIncludedVAT": "string",  
"N2MissingEnergySppdIncludedVAT": "string",  
"D1MissingEnergyIncludedVAT": "string",  
"D1MissingEnergyViapIncludedVAT": "string",  
"D1MissingEnergySppdIncludedVAT": "string",

```

"D2MissingEnergyIncludedVAT": "string",
"D2MissingEnergyViaplIncludedVAT": "string",
"D2MissingEnergySppdIncludedVAT": "string",
"N1MissingEnergyIncludedVAT": "string",
"N1MissingEnergyViaplIncludedVAT": "string",
"N1MissingEnergySppdIncludedVAT": "string",
"PowerPlantCapacityIncludedVAT": "string",
"PowerPlantCapacityUnit": "string"
}
]

```

Attribute	type	obligation	description
-	-	-	Response description are provided in <u>additional documentation</u> . In next document version, all fields description will be provided here.

Below are the error codes and messages. Response codes and response content in case of error:

### 7.5.1.3 Response Error codes

Code	Message	Explanation
1.	Currently accounting data are not complete and it will be generated within 5 working days. You will be informed separately as soon as data will be complete and ready for a use.	-
1004	The value of the count parameter must be less or equal to 10 000.	The value of the count parameter cannot be above 10 000.

### 7.5.2 POST /reports/accounting-data-pack-b2c-count

<b>URI</b>	POST /reports/accounting-data-pack-b2c-count
<b>Description</b>	Method which will return count (number), how many items Supplier will get in „POST /reports/accounting-data-pack-b2c“ report (reports could have more than 1 item, so it is List). It should be used when supplier need to split data in few portions. This response should be used in „POST /reports/accounting-data-pack-b2c“ method request, where Supplier can provide method parameters information.
<b>Parameters</b>	none



<b>Request Body</b>	Data order must be submitted in HTTP request body in a form of JSON		
<b>Response</b>	<b>HTTP status code</b>	<b>Reason</b>	<b>Response description</b>
	201	Created	Request completed successfully
	400	Bad Request	Request error. The HTTP response body provides a list of errors in JSON format.
	401	Unauthorized	An attempt was made to connect to a non-public method that requires authentication, but no user credentials were provided.
	403	Forbidden	According to the access control policy, the current user does not have access to perform the requested action.
	404	Not Found	Either there is no API method associated with the request URL path, or the request contains one or more parameters that did not return the data.
	423	Locked	The source or destination resource of a method is locked. This response SHOULD contain an appropriate precondition or postcondition code, such as 'lock-token-submitted' or 'no-conflicting-lock'.
<b>Rules</b>	<b>No.</b>	<b>Rule description</b>	<b>Attributes</b>
	0.	If an attribute has defined possible values, the value index can be specified by specifying the value of the attribute in the request. Indices of all possible values start from 0.	All attributes with specified values.
	1.	Counts report list items and return SUM of all report lines	-
	2.	The operator does not provide interim data. The operator provides only final / complete data.	-

### 7.5.2.1 JSON Request structure

JSON Request structure

```
{
  "customerCode": "string",
  "dateFrom": "date",
  "dateTo": "date",
  "objectNo": "string"
}
```

Attribute	type	obligation	description
customerCode	String(32)	not required	User code of contracted customer
dateFrom	Date	required	Date from which data from DSO Billing system should be included into report
dateTo	Date	required	Date to which data from DSO Billing system should be included into report
objectNo	String(20)	not required	Object Number of the object for the supply of electricity in which the contract is concluded.

### 7.5.2.2 JSON Response structure

JSON Response structure

```
{
  "count": "number"
}
```

Attribute	type	obligation	description
count	number(10)	required	Returns number, how many items are in report items list. This response can be used in accounting-data-pack-b2c report parameters to split data in few response portions (if need pagination)

Below are the error codes and messages. Response codes and response content in case of error:

### 7.5.2.3 Response Error codes

Code	Message	Explanation
1.	Currently accounting data are not complete and it will be generated within 5 working days. You will be informed separately as soon as data will be complete and ready for a use.	-

### 7.5.3 POST /reports/accounting-data-pack-b2b-meters-level?first={integer}&count={integer}

<b>URI</b>	POST /reports/accounting-data-pack-b2b-meters-level?first={integer}&count={integer}		
<b>Description</b>	Report which will return accounting data in meter level for Business clients. If business client object has two meters, this method will return list of two items.		
<b>Parameters</b>	URL parameters:  first - the index of the report line, which must be the first in the return list (starting from 0). Optional. The default value is 0. count - the number of report rows in the return list. Optional. The default value is 30.		
<b>Request Body</b>	Data order must be submitted in HTTP request body in a form of JSON		
<b>Response</b>	<b>HTTP status code</b>	<b>Reason</b>	<b>Response description</b>
	201	Created	Request completed successfully
	400	Bad Request	Request error. The HTTP response body provides a list of errors in JSON format.
	401	Unauthorized	An attempt was made to connect to a non-public method that requires authentication, but no user credentials were provided.
	403	Forbidden	According to the access control policy, the current user does not have access to perform the requested action.

	404	Not Found	Either there is no API method associated with the request URL path, or the request contains one or more parameters that did not return the data.
	423	Locked	The source or destination resource of a method is locked.  This response SHOULD contain an appropriate precondition or postcondition code, such as 'lock-token-submitted' or 'no-conflicting-lock'.
<b>Rules</b>	<b>No.</b>	<b>Rule description</b>	<b>Attributes</b>
	0.	If an attribute has defined possible values, the value index can be specified by specifying the value of the attribute in the request. Indices of all possible values start from 0.	All attributes with specified values.
	1.	The value of the count parameter cannot be above 10 000. If the error occurs the error message 1004 will be displayed.	count
	2.	Depending on the dateFrom and dateTo fields specified in the request, the request is executed and the report data is selected and submitted. If only date fields are specified, then the report returns information about all objects in all customer contracts.	dateFrom, dateTo
	3.	Depending on the dateFrom and dateTo fields specified in the request, the request is executed and the report data is selected and submitted. If date fields and customerCode are specified, then the report returns information about all objects in provided customer contract.	dateFrom, dateTo, customerCode
	4.	Depending on the dateFrom and dateTo fields specified in the request, the request is executed and the report data is selected and submitted. If date fields, customerCode and objectNo are specified, then the report returns information about provided object in provided customer contract.	dateFrom, dateTo, customerCode, objectNo
	5.	The operator does not provide interim data. The operator provides only final / complete data.	-

### 7.5.3.1 JSON Request structure

### JSON Request structure

```
{
  "customerCode": "string",
  "dateFrom": "date",
  "dateTo": "date",
  "objectNo": "string"
}
```

Attribute	type	obligation	description
customerCode	String(32)	not required	User code of contracted customer
dateFrom	Date	required	Date from which data from DSO Billing system should be included into report
dateTo	Date	required	Date to which data from DSO Billing system should be included into report
objectNo	String(20)	not required	Object Number of the object for the supply of electricity in which the contract is concluded.

The table below describes URL request attributes:

Attribute	type	obligation	description
first	integer	not required	Index (starting from 0) of the object that must be presented first in the return list.
count	integer	not required	Number of objects in the return list.

### 7.5.3.2 JSON Response structure

#### JSON Response structure

```
[
{
  "CustomerID": 0,
  "ClientID": "string",
  "ClientName": "string",
  "ClientAddress": "string",
  "ObjectID": 0,
```

"ObjectNumber": "string",  
"ObjectName": "string",  
"ObjectType": "string",  
"GeneratingCustomer": true,  
"ObjectAddress": "string",  
"AgreementType": "string",  
"AgreementModel": "string",  
"AgreementFrom": 0,  
"AgreementTo": 0,  
"PermittablePowerConsumption": 0,  
"PermittablePowerGeneration": 0,  
"InstalledGeneratingPower": 0,  
"InstalledConsumptionPower": 0,  
"MetersAmount": 0,  
"AutoMetersAmount": 0,  
"ReportingPeriod": "2020-09-02",  
"BillingPeriod": "2020-09-02",  
"SupplyState": "string",  
"SupplyStateFrom": "2020-09-02",  
"SupplyStateTo": "2020-09-02",  
"MetersNumber": "string",  
"ReadingsSource": "string",  
"ReadingsReceiveDate": "2020-09-02",  
"PaymentType": "string",  
"DeclarationReferenceType": "string",  
"Service": "string",  
"ReferenceSubmitDate": "2020-09-02",  
"ReadingsSubmitDate": "2020-09-02",  
"DeclarationReferenceNumber": 0,  
"UnaccountedConsumptionActNumber": 0,  
"UnaccountedConsumptionActCreateDate": "2020-09-02",  
"UnaccountedConsumptionActFrom": "2020-09-02",  
"UnaccountedConsumptionActTo": "2020-09-02",  
"ConsumptionConversionActNumber": "string",  
"ConsumptionConversionActCreateDate": "2020-09-02",  
"ConsumptionConversionActFrom": "2020-09-02",  
"ConsumptionConversionActTo": "2020-09-02",  
"ConsumptionState": "string",  
"ConsumptionStateFrom": "2020-09-02",  
"ConsumptionStateTo": "2020-09-02",  
"TariffPlan": "string",  
"PowerPlantCapacityDateFrom": "2020-09-02",

"EnergyObtainedDateFrom": "2020-09-02",  
"PowerPlantCapacityDateTo": "2020-09-02",  
"PowerPlantCapacitySource": "string",  
"PowerPlantCapacitySourceDateFrom": "2020-09-02",  
"PowerPlantCapacitySourceDateTo": "2020-09-02",  
"EnergyObtainedDateTo": "2020-09-02",  
"EnergyObtainedPowerKw": 0,  
"TariffPlanChangeDate": "2020-09-02",  
"ConsumptionConversionAct": true,  
"UnaccountedAct": true,  
"ConversionAct": true,  
"OperatorGridElectricityPercent": 0,  
"ClientGridElectricityPercent": 0,  
"GaConsumptionAmount": 0,  
"VkConsumptionAmount": 0,  
"VkViapConsumptionAmount": 0,  
"VkSppdConsumptionAmount": 0,  
"VkDiscountConsumptionAmount": 0,  
"DdConsumptionAmount": 0,  
"DdViapConsumptionAmount": 0,  
"DdSppdConsumptionAmount": 0,  
"DdDiscountConsumptionAmount": 0,  
"NkConsumptionAmount": 0,  
"NkViapConsumptionAmount": 0,  
"NkSppdConsumptionAmount": 0,  
"NkDiscountConsumptionAmount": 0,  
"MaConsumptionAmount": 0,  
"MaViapConsumptionAmount": 0,  
"VdConsumptionAmount": 0,  
"VdViapConsumptionAmount": 0,  
"SvConsumptionAmount": 0,  
"SvViapConsumptionAmount": 0,  
"MiConsumptionAmount": 0,  
"MiViapConsumptionAmount": 0,  
"RvConsumptionAmount": 0,  
"RgConsumptionAmount": 0,  
"VgConsumptionAmount": 0,  
"Reliability1ConsumptionAmount": 0,  
"Reliability2ConsumptionAmount": 0,  
"Reliability3ConsumptionAmount": 0,  
"TechnologicalCostsViapConsumptionAmount": 0,  
"TechnologicalCostsConsumptionAmount": 0,

"GeneralInterestConsumptionAmount": 0,  
"VkConsumedElectricityConsumptionAmount": 0,  
"DdConsumedElectricityConsumptionAmount": 0,  
"NkConsumedElectricityConsumptionAmount": 0,  
"MaConsumedElectricityConsumptionAmount": 0,  
"VdConsumedElectricityConsumptionAmount": 0,  
"SvConsumedElectricityConsumptionAmount": 0,  
"MiConsumedElectricityConsumptionAmount": 0,  
"VkPayingRecoveredEnergyConsumptionAmount": 0,  
"DdPayingRecoveredEnergyConsumptionAmount": 0,  
"NkPayingRecoveredEnergyConsumptionAmount": 0,  
"MaPayingRecoveredEnergyConsumptionAmount": 0,  
"VdPayingRecoveredEnergyConsumptionAmount": 0,  
"SvPayingRecoveredEnergyConsumptionAmount": 0,  
"MiPayingRecoveredEnergyConsumptionAmount": 0,  
"VkPayingRecoveredPercentConsumptionAmount": 0,  
"DdPayingRecoveredPercentConsumptionAmount": 0,  
"NkPayingRecoveredPercentConsumptionAmount": 0,  
"MaPayingRecoveredPercentConsumptionAmount": 0,  
"VdPayingRecoveredPercentConsumptionAmount": 0,  
"SvPayingRecoveredPercentConsumptionAmount": 0,  
"MiPayingRecoveredPercentConsumptionAmount": 0,  
"VkPayingRecoveredPowerConsumptionAmount": 0,  
"DdPayingRecoveredPowerConsumptionAmount": 0,  
"NkPayingRecoveredPowerConsumptionAmount": 0,  
"MaPayingRecoveredPowerConsumptionAmount": 0,  
"VdPayingRecoveredPowerConsumptionAmount": 0,  
"SvPayingRecoveredPowerConsumptionAmount": 0,  
"MiPayingRecoveredPowerConsumptionAmount": 0,  
"VkPayingRecoveredMixedConsumptionAmount": 0,  
"DdPayingRecoveredMixedConsumptionAmount": 0,  
"NkPayingRecoveredMixedConsumptionAmount": 0,  
"MaPayingRecoveredMixedConsumptionAmount": 0,  
"VdPayingRecoveredMixedConsumptionAmount": 0,  
"SvPayingRecoveredMixedConsumptionAmount": 0,  
"MiPayingRecoveredMixedConsumptionAmount": 0,  
"VkMissingEnergyConsumptionAmount": 0,  
"VkMissingEnergyViapConsumptionAmount": 0,  
"VkMissingEnergySppdConsumptionAmount": 0,  
"DdMissingEnergyConsumptionAmount": 0,  
"DdMissingEnergyViapConsumptionAmount": 0,  
"DdMissingEnergySppdConsumptionAmount": 0,



"NkMissingEnergyConsumptionAmount": 0,  
"NkMissingEnergyViapConsumptionAmount": 0,  
"NkMissingEnergySppdConsumptionAmount": 0,  
"MaMissingEnergyConsumptionAmount": 0,  
"MaMissingEnergyViapConsumptionAmount": 0,  
"VdMissingEnergyConsumptionAmount": 0,  
"VdMissingEnergyViapConsumptionAmount": 0,  
"SvMissingEnergyConsumptionAmount": 0,  
"SvMissingEnergyViapConsumptionAmount": 0,  
"MiMissingEnergyConsumptionAmount": 0,  
"MiMissingEnergyViapConsumptionAmount": 0,  
"VkMissingEnergyDiscountConsumptionAmount": 0,  
"DdMissingEnergyDiscountConsumptionAmount": 0,  
"NkMissingEnergyDiscountConsumptionAmount": 0,  
"GridSuppliedConsumptionAmount": 0,  
"AccumulatedBeginningConsumptionAmount": 0,  
"AccumulatedEndConsumptionAmount": 0,  
"AccumulatedTransferredConsumptionAmount": 0,  
"AccumulatedUploadedConsumptionAmount": 0,  
"AccumulatedRaisedConsumptionAmount": 0,  
"CompensatedConsumptionAmount": 0,  
"OldIndependentSupplier": "string",  
"PowerPlantCapacityConsumptionAmount": 0,  
"EnergyObtainedConsumptionAmount": 0,  
"OperatorGridElectricityConsumptionAmount": 0,  
"ClientGridElectricityConsumptionAmount": 0,  
"PowerPlantCapacityUnit": "string",  
"GaUnit": "string",  
"VkUnit": "string",  
"VkViapUnit": "string",  
"VkSppdUnit": "string",  
"VkDiscountUnit": "string",  
"DdUnit": "string",  
"DdViapUnit": "string",  
"DdSppdUnit": "string",  
"DdDiscountUnit": "string",  
"NkUnit": "string",  
"NkViapUnit": "string",  
"NkSppdUnit": "string",  
"NkDiscountUnit": "string",  
"MaUnit": "string",  
"MaViapUnit": "string",

"VdUnit": "string",  
"VdViapUnit": "string",  
"SvUnit": "string",  
"SvViapUnit": "string",  
"MiUnit": "string",  
"MiViapUnit": "string",  
"RvUnit": "string",  
"RgUnit": "string",  
"VgUnit": "string",  
"Reliability1Unit": "string",  
"Reliability2Unit": "string",  
"Reliability3Unit": "string",  
"TechnologicalCostsViapUnit": "string",  
"TechnologicalCostsUnit": "string",  
"GeneralInterestUnit": "string",  
"VkConsumedElectricityUnit": "string",  
"DdConsumedElectricityUnit": "string",  
"NkConsumedElectricityUnit": "string",  
"MaConsumedElectricityUnit": "string",  
"VdConsumedElectricityUnit": "string",  
"SvConsumedElectricityUnit": "string",  
"MiConsumedElectricityUnit": "string",  
"VkPayingRecoveredEnergyUnit": "string",  
"DdPayingRecoveredEnergyUnit": "string",  
"NkPayingRecoveredEnergyUnit": "string",  
"MaPayingRecoveredEnergyUnit": "string",  
"VdPayingRecoveredEnergyUnit": "string",  
"SvPayingRecoveredEnergyUnit": "string",  
"MiPayingRecoveredEnergyUnit": "string",  
"VkPayingRecoveredPercentUnit": "string",  
"DdPayingRecoveredPercentUnit": "string",  
"NkPayingRecoveredPercentUnit": "string",  
"MaPayingRecoveredPercentUnit": "string",  
"VdPayingRecoveredPercentUnit": "string",  
"SvPayingRecoveredPercentUnit": "string",  
"MiPayingRecoveredPercentUnit": "string",  
"VkPayingRecoveredPowerUnit": "string",  
"DdPayingRecoveredPowerUnit": "string",  
"NkPayingRecoveredPowerUnit": "string",  
"MaPayingRecoveredPowerUnit": "string",  
"VdPayingRecoveredPowerUnit": "string",  
"SvPayingRecoveredPowerUnit": "string",

"MiPayingRecoveredPowerUnit": "string",  
"VkPayingRecoveredMixedUnit": "string",  
"DdPayingRecoveredMixedUnit": "string",  
"NkPayingRecoveredMixedUnit": "string",  
"MaPayingRecoveredMixedUnit": "string",  
"VdPayingRecoveredMixedUnit": "string",  
"SvPayingRecoveredMixedUnit": "string",  
"MiPayingRecoveredMixedUnit": "string",  
"VkMissingEnergyUnit": "string",  
"VkMissingEnergyViapUnit": "string",  
"VkMissingEnergySppdUnit": "string",  
"DdMissingEnergyUnit": "string",  
"DdMissingEnergyViapUnit": "string",  
"DdMissingEnergySppdUnit": "string",  
"NkMissingEnergyUnit": "string",  
"NkMissingEnergyViapUnit": "string",  
"NkMissingEnergySppdUnit": "string",  
"MaMissingEnergyUnit": "string",  
"MaMissingEnergyViapUnit": "string",  
"VdMissingEnergyUnit": "string",  
"VdMissingEnergyViapUnit": "string",  
"SvMissingEnergyUnit": "string",  
"SvMissingEnergyViapUnit": "string",  
"MiMissingEnergyUnit": "string",  
"MiMissingEnergyViapUnit": "string",  
"VkMissingEnergyDiscountUnit": "string",  
"DdMissingEnergyDiscountUnit": "string",  
"NkMissingEnergyDiscountUnit": "string",  
"VkReadingsFrom": 0,  
"DdReadingsFrom": 0,  
"NkReadingsFrom": 0,  
"MaReadingsFrom": 0,  
"VdReadingsFrom": 0,  
"SvReadingsFrom": 0,  
"MiReadingsFrom": 0,  
"RvReadingsFrom": 0,  
"RgReadingsFrom": 0,  
"VkConsumedElectricityReadingsFrom": 0,  
"DdConsumedElectricityReadingsFrom": 0,  
"NkConsumedElectricityReadingsFrom": 0,  
"MaConsumedElectricityReadingsFrom": 0,  
"VdConsumedElectricityReadingsFrom": 0,

"SvConsumedElectricityReadingsFrom": 0,  
"MiConsumedElectricityReadingsFrom": 0,  
"GridSuppliedReadingsFrom": 0,  
"VkReadingsTo": 0,  
"DdReadingsTo": 0,  
"NkReadingsTo": 0,  
"MaReadingsTo": 0,  
"VdReadingsTo": 0,  
"SvReadingsTo": 0,  
"MiReadingsTo": 0,  
"RvReadingsTo": 0,  
"RgReadingsTo": 0,  
"VkConsumedElectricityReadingsTo": 0,  
"DdConsumedElectricityReadingsTo": 0,  
"NkConsumedElectricityReadingsTo": 0,  
"MaConsumedElectricityReadingsTo": 0,  
"VdConsumedElectricityReadingsTo": 0,  
"SvConsumedElectricityReadingsTo": 0,  
"MiConsumedElectricityReadingsTo": 0,  
"GridSuppliedReadingsTo": 0,  
"GaPriceEur": 0,  
"VkPriceEur": 0,  
"VkViapPriceEur": 0,  
"VkSppdPriceEur": 0,  
"VkDiscountPriceEur": 0,  
"DdPriceEur": 0,  
"DdViapPriceEur": 0,  
"DdSppdPriceEur": 0,  
"DdDiscountPriceEur": 0,  
"NkPriceEur": 0,  
"NkViapPriceEur": 0,  
"NkSppdPriceEur": 0,  
"NkDiscountPriceEur": 0,  
"MaPriceEur": 0,  
"MaViapPriceEur": 0,  
"VdPriceEur": 0,  
"VdViapPriceEur": 0,  
"SvPriceEur": 0,  
"SvViapPriceEur": 0,  
"MiPriceEur": 0,  
"MiViapPriceEur": 0,  
"RvPriceEur": 0,

"RgPriceEur": 0,  
"VgPriceEur": 0,  
"Reliability1PriceEur": 0,  
"Reliability2PriceEur": 0,  
"Reliability3PriceEur": 0,  
"TechnologicalCostsViapPriceEur": 0,  
"TechnologicalCostsPriceEur": 0,  
"GeneralInterestPriceEur": 0,  
"VkPayingRecoveredEnergyPriceEur": 0,  
"DdPayingRecoveredEnergyPriceEur": 0,  
"NkPayingRecoveredEnergyPriceEur": 0,  
"MaPayingRecoveredEnergyPriceEur": 0,  
"VdPayingRecoveredEnergyPriceEur": 0,  
"SvPayingRecoveredEnergyPriceEur": 0,  
"MiPayingRecoveredEnergyPriceEur": 0,  
"VkPayingRecoveredMixedPriceEur": 0,  
"DdPayingRecoveredMixedPriceEur": 0,  
"NkPayingRecoveredMixedPriceEur": 0,  
"MaPayingRecoveredMixedPriceEur": 0,  
"VdPayingRecoveredMixedPriceEur": 0,  
"SvPayingRecoveredMixedPriceEur": 0,  
"MiPayingRecoveredMixedPriceEur": 0,  
"VkMissingEnergyPriceEur": 0,  
"VkMissingEnergyViapPriceEur": 0,  
"VkMissingEnergySppdPriceEur": 0,  
"DdMissingEnergyPriceEur": 0,  
"DdMissingEnergyViapPriceEur": 0,  
"DdMissingEnergySppdPriceEur": 0,  
"NkMissingEnergyPriceEur": 0,  
"NkMissingEnergyViapPriceEur": 0,  
"NkMissingEnergySppdPriceEur": 0,  
"MaMissingEnergyPriceEur": 0,  
"MaMissingEnergyViapPriceEur": 0,  
"VdMissingEnergyPriceEur": 0,  
"VdMissingEnergyViapPriceEur": 0,  
"SvMissingEnergyPriceEur": 0,  
"SvMissingEnergyViapPriceEur": 0,  
"MiMissingEnergyPriceEur": 0,  
"MiMissingEnergyViapPriceEur": 0,  
"VkMissingEnergyDiscountPriceEur": 0,  
"DdMissingEnergyDiscountPriceEur": 0,  
"NkMissingEnergyDiscountPriceEur": 0,

"PowerPlantCapacityPriceEur": 0,  
"GaDiscount": 0,  
"VkDiscount": 0,  
"VkViapDiscount": 0,  
"VkSppdDiscount": 0,  
"VkDiscountDiscount": 0,  
"DdDiscount": 0,  
"DdViapDiscount": 0,  
"DdSppdDiscount": 0,  
"DdDiscountDiscount": 0,  
"NkDiscount": 0,  
"NkViapDiscount": 0,  
"NkSppdDiscount": 0,  
"NkDiscountDiscount": 0,  
"MaDiscount": 0,  
"MaViapDiscount": 0,  
"VdDiscount": 0,  
"VdViapDiscount": 0,  
"SvDiscount": 0,  
"SvViapDiscount": 0,  
"MiDiscount": 0,  
"MiViapDiscount": 0,  
"RvDiscount": 0,  
"RgDiscount": 0,  
"VgDiscount": 0,  
"Reliability1Discount": 0,  
"Reliability2Discount": 0,  
"Reliability3Discount": 0,  
"TechnologicalCostsViapDiscount": 0,  
"TechnologicalCostsDiscount": 0,  
"GeneralInterestDiscount": 0,  
"VkPayingRecoveredEnergyDiscount": 0,  
"VkPayingRecoveredMixedDiscount": 0,  
"VkMissingEnergyDiscount": 0,  
"VkMissingEnergyViapDiscount": 0,  
"VkMissingEnergySppdDiscount": 0,  
"VkMissingEnergyDiscountDiscount": 0,  
"GaAmountNoVAT": 0,  
"VkAmountNoVAT": 0,  
"VkViapAmountNoVAT": 0,  
"VkSppdAmountNoVAT": 0,  
"VkDiscountAmountNoVAT": 0,

"DdAmountNoVAT": 0,  
"DdViapAmountNoVAT": 0,  
"DdSppdAmountNoVAT": 0,  
"DdDiscountAmountNoVAT": 0,  
"NkAmountNoVAT": 0,  
"NkViapAmountNoVAT": 0,  
"NkSppdAmountNoVAT": 0,  
"NkDiscountAmountNoVAT": 0,  
"MaAmountNoVAT": 0,  
"MaViapAmountNoVAT": 0,  
"VdAmountNoVAT": 0,  
"VdViapAmountNoVAT": 0,  
"SvAmountNoVAT": 0,  
"SvViapAmountNoVAT": 0,  
"MiAmountNoVAT": 0,  
"MiViapAmountNoVAT": 0,  
"RvAmountNoVAT": 0,  
"RgAmountNoVAT": 0,  
"VgAmountNoVAT": 0,  
"Reliability1AmountNoVAT": 0,  
"Reliability2AmountNoVAT": 0,  
"Reliability3AmountNoVAT": 0,  
"TechnologicalCostsViapAmountNoVAT": 0,  
"TechnologicalCostsAmountNoVAT": 0,  
"GeneralInterestAmountNoVAT": 0,  
"VkPayingRecoveredEnergyAmountNoVAT": 0,  
"DdPayingRecoveredEnergyAmountNoVAT": 0,  
"NkPayingRecoveredEnergyAmountNoVAT": 0,  
"MaPayingRecoveredEnergyAmountNoVAT": 0,  
"VdPayingRecoveredEnergyAmountNoVAT": 0,  
"SvPayingRecoveredEnergyAmountNoVAT": 0,  
"MiPayingRecoveredEnergyAmountNoVAT": 0,  
"VkPayingRecoveredMixedAmountNoVAT": 0,  
"DdPayingRecoveredMixedAmountNoVAT": 0,  
"NkPayingRecoveredMixedAmountNoVAT": 0,  
"MaPayingRecoveredMixedAmountNoVAT": 0,  
"VdPayingRecoveredMixedAmountNoVAT": 0,  
"SvPayingRecoveredMixedAmountNoVAT": 0,  
"MiPayingRecoveredMixedAmountNoVAT": 0,  
"VkMissingEnergyAmountNoVAT": 0,  
"VkMissingEnergyViapAmountNoVAT": 0,  
"VkMissingEnergySppdAmountNoVAT": 0,

```

"DdMissingEnergyAmountNoVAT": 0,
"DdMissingEnergyViapAmountNoVAT": 0,
"DdMissingEnergySppdAmountNoVAT": 0,
"NkMissingEnergyAmountNoVAT": 0,
"NkMissingEnergyViapAmountNoVAT": 0,
"NkMissingEnergySppdAmountNoVAT": 0,
"MaMissingEnergyAmountNoVAT": 0,
"MaMissingEnergyViapAmountNoVAT": 0,
"VdMissingEnergyAmountNoVAT": 0,
"VdMissingEnergyViapAmountNoVAT": 0,
"SvMissingEnergyAmountNoVAT": 0,
"SvMissingEnergyViapAmountNoVAT": 0,
"MiMissingEnergyAmountNoVAT": 0,
"MiMissingEnergyViapAmountNoVAT": 0,
"VkMissingEnergyDiscountAmountNoVAT": 0,
"DdMissingEnergyDiscountAmountNoVAT": 0,
"NkMissingEnergyDiscountAmountNoVAT": 0,
"PowerPlantCapacityAmountNoVAT": 0,
"PermanentHomePlusAmountNoVAT": 0,
"PermanentHomeAmountNoVAT": 0
}
]

```

Attribute	type	obligation	description
-	-	-	Response description are provided in <a href="https://datahub.eso.lt/dokumentacija">https://datahub.eso.lt/dokumentacija</a> . In next document version, all fields description will be provided here.

Below are the error codes and messages. Response codes and response content in case of error:

### 7.5.3.3 Response Error codes

Code	Message	Explanation
1.	Currently accounting data are not complete and it will be generated within 5 working days. You will be informed separately as soon as data will be complete and ready for a use.	-
1004	The value of the count parameter must be less or equal to 10 000.	The value of the count parameter cannot be above 10 000.



### 7.5.4 POST /reports/accounting-data-pack-b2b-meters-level-count

<b>URI</b>	POST /reports/accounting-data-pack-b2b-meters-level-count		
<b>Description</b>	Method which will return count (number), how many items Supplier will get in „POST /reports/accounting-data-pack-b2b-meters-level“ report (reports could have more than 1 item, so it is List). It should be used when supplier need to split data in few portions. This response should be used in „POST /reports/accounting-data-pack-b2b-meters-level“ method request, where Supplier can provide method parameters information.		
<b>Parameters</b>	none		
<b>Request Body</b>	Data order must be submitted in HTTP request body in a form of JSON		
<b>Response</b>	<b>HTTP status code</b>	<b>Reason</b>	<b>Response description</b>
	201	Created	Request completed successfully
	400	Bad Request	Request error. The HTTP response body provides a list of errors in JSON format.
	401	Unauthorized	An attempt was made to connect to a non-public method that requires authentication, but no user credentials were provided.
	403	Forbidden	According to the access control policy, the current user does not have access to perform the requested action.
	404	Not Found	Either there is no API method associated with the request URL path, or the request contains one or more parameters that did not return the data.
	423	Locked	The source or destination resource of a method is locked.

			This response SHOULD contain an appropriate precondition or postcondition code, such as 'lock-token-submitted' or 'no-conflicting-lock'.
Rules	No.	Rule description	Attributes
	0.	If an attribute has defined possible values, the value index can be specified by specifying the value of the attribute in the request. Indices of all possible values start from 0.	All attributes with specified values.
	1.	Counts report list items and return SUM of all report lines	-
	2.	The operator does not provide interim data. The operator provides only final / complete data.	

#### 7.5.4.1 JSON Request structure

JSON Request structure			
<pre>{ "customerCode": "string", "dateFrom": "date", "dateTo": "date", "objectNo": "string" }</pre>			
Attribute	type	obligation	description
customerCode	String(32)	not required	User code of contracted customer
dateFrom	Date	required	Date from which data from DSO Billing system should be included into report
dateTo	Date	required	Date to which data from DSO Billing system should be included into report
objectNo	String(20)	not required	Object Number of the object for the supply of electricity in which the contract is concluded.

#### 7.5.4.2 JSON Response structure

JSON Response structure			
-------------------------	--	--	--

```
{
  "count": "number"
}
```

Attribute	type	obligation	description
count	number(10)	required	Returns number, how many items are in report items list. This response can be used in accounting-data-pack-b2b-meters-level report parameters to split data in few response portions (if need pagination)

Below are the error codes and messages. Response codes and response content in case of error:

#### 7.5.4.3 Response Error codes

Code	Message	Explanation
1.	Currently accounting data are not complete and it will be generated within 5 working days. You will be informed separately as soon as data will be complete and ready for a use.	-

#### 7.5.5 POST /reports/objects-data-pack?first={integer}&count={integer}

<b>URI</b>	POST /reports/objects-data-pack?first={integer}&count={integer}		
<b>Description</b>	Report which will return object information for both Business or Household customer.		
<b>Parameters</b>	URL parameters:  first - the index of the report line, which must be the first in the return list (starting from 0). Optional. The default value is 0. count - the number of report rows in the return list. Optional. The default value is 30.		
<b>Request Body</b>	Data order must be submitted in HTTP request body in a form of JSON		
<b>Response</b>	<b>HTTP status code</b>	<b>Reason</b>	<b>Response description</b>

	201	Created	Request completed successfully
	400	Bad Request	Request error. The HTTP response body provides a list of errors in JSON format.
	401	Unauthorized	An attempt was made to connect to a non-public method that requires authentication, but no user credentials were provided.
	403	Forbidden	According to the access control policy, the current user does not have access to perform the requested action.
	404	Not Found	Either there is no API method associated with the request URL path, or the request contains one or more parameters that did not return the data.
	423	Locked	The source or destination resource of a method is locked.  This response SHOULD contain an appropriate precondition or postcondition code, such as 'lock-token-submitted' or 'no-conflicting-lock'.
<b>Rules</b>	<b>No.</b>	<b>Rule description</b>	<b>Attributes</b>
	0.	If an attribute has defined possible values, the value index can be specified by specifying the value of the attribute in the request. Indices of all possible values start from 0.	All attributes with specified values.
	1.	The value of the count parameter cannot be above 10 000. If the error occurs the error message 1004 will be displayed.	count
	2.	Depending on the dateFrom and dateTo fields specified in the request, the request is executed and the report data is selected and submitted. If only date fields are specified, then the report returns information about all objects in all customer contracts.	dateFrom, dateTo

	3.	Depending on the dateFrom and dateTo fields specified in the request, the request is executed and the report data is selected and submitted. If date fields and customerCode are specified, then the report returns information about all objects in provided customer contract.	dateFrom, dateTo, customerCode
	4.	Depending on the dateFrom and dateTo fields specified in the request, the request is executed and the report data is selected and submitted. If date fields, customerCode and objectNo are specified, then the report returns information about provided object in provided customer contract.	dateFrom, dateTo, customerCode, objectNo
	5.	The operator does not provide interim data. The operator provides only final / complete data.	-
	6.	Depending on the contractType field specified in the request, the request is executed, and the report data is selected and submitted. If the contractType field does not specified, when the request is executed, in the report must be included all data depending from other parameters.	contractType

#### 7.5.5.1 JSON Request structure

##### JSON Request structure

```
{
  "customerCode": "string",
  "dateFrom": "date",
  "dateTo": "date",
  "objectNo": "string",
  "contractType": "string"
}
```

Attribute	type	obligation	description
customerCode	String(32)	not required	User code of contracted customer
dateFrom	Date	required	Date from which data from DSO Billing system should be included into report
dateTo	Date	required	Date to which data from DSO Billing system should be included into report
objectNo	String(20)	not required	Object Number of the object for the supply of electricity in which the contract is concluded.
contractType	String(4)	not required	Contract type of the current object. Possible meanings:

- ~~SBTS – Household customer;~~
- ~~SKMS – Commercial customer.~~

### 7.5.5.2 JSON Response structure

The table below describes URL request attributes:

Attribute	type	obligation	description
<b>first</b>	integer	not required	Index (starting from 0) of the object that must be presented first in the return list.
<b>count</b>	integer	not required	Number of objects in the return list.

#### JSON Response structure

```
[
{
"AgreementFrom": "2020-09-22",
"AgreementModel": "string",
"AgreementTo": "2020-09-22",
"AgreementType": "string",
"AutoMetersAmount": 0,
"ClientID": "string",
"ClientName": "string",
"ConsumptionState": "string",
"ConsumptionStateFrom": "2020-09-22",
"ConsumptionStateTo": "2020-09-22",
"CustomerID": "string",
"GeneratingCustomer": "string",
"PayoffMethod": "string",
"MetersAmount": 0,
"ObjectAddress": "string",
"ObjectID": 0,
"ObjectName": "string",
"ObjectNumber": "string",
"ObjectType": "string",
"PermittablePowerConsumption": 0,
"PermittablePowerGeneration": 0,
```

Attribute	type	obligation	description
			<pre>"PowerPlantType": "string", "SupplyState": "string", "SupplyStateFrom": "2020-09-22", "SupplyStateTo": "2020-09-22", "TariffPlan": "string", "TariffPlanChangeDate": "2020-09-22", "TechnicalCosts": "string", "TotalProducts": 0, "TotalScales": 0, "Voltage": 0 } ]</pre>
Attribute	type	obligation	description
-	-	-	Response description are provided in <a href="https://datahub.eso.lt/dokumentacija">https://datahub.eso.lt/dokumentacija</a> . In next document version, all fields description will be provided here.

Below are the error codes and messages. Response codes and response content in case of error:

### 7.5.5.3 Response Error codes

Code	Message	Explanation
1.	Currently accounting data are not complete, and it will be generated within 5 working days. You will be informed separately as soon as data will be complete and ready for a use.	-
1004	The value of the count parameter must be less or equal to 10 000.	The value of the count parameter cannot be above 10 000.

### 7.5.6 POST /reports/objects-data-pack-count

URI	POST /reports/objects-data-pack-count
-----	---------------------------------------

<b>Description</b>	Method which will return count (number), how many items Supplier will get in „POST /reports/objects-data-pack“ report (reports could have more than 1 item, so it is List). It should be used when supplier need to split data in few portions. This response should be used in „POST /reports/objects-data-pack“ method request, where Supplier can provide method parameters information.		
<b>Parameters</b>	none		
<b>Request Body</b>	Data order must be submitted in HTTP request body in a form of JSON		
<b>Response</b>	<b>HTTP status code</b>	<b>Reason</b>	<b>Response description</b>
	201	Created	Request completed successfully
	400	Bad Request	Request error. The HTTP response body provides a list of errors in JSON format.
	401	Unauthorized	An attempt was made to connect to a non-public method that requires authentication, but no user credentials were provided.
	403	Forbidden	According to the access control policy, the current user does not have access to perform the requested action.
	404	Not Found	Either there is no API method associated with the request URL path, or the request contains one or more parameters that did not return the data.
	423	Locked	The source or destination resource of a method is locked. This response SHOULD contain an appropriate precondition or postcondition code, such as 'lock-token-submitted' or 'no-conflicting-lock'.
<b>Rules</b>	<b>No.</b>	<b>Rule description</b>	<b>Attributes</b>
	0.	If an attribute has defined possible values, the value index can be specified by specifying the value of the attribute in the request. Indices of all possible values start from 0.	All attributes with specified values.
	1.	Counts report list items and return SUM of all report lines	-



	2.	The operator does not provide interim data. The operator provides only final / complete data.	-
--	----	---	---

### 7.5.6.1 JSON Request structure

JSON Request structure			
<pre>{ "customerCode": "string", "dateFrom": "date", "dateTo": "date", "objectNo": "string" }</pre>			
Attribute	type	obligation	description
customerCode	String(32)	not required	User code of contracted customer
dateFrom	Date	required	Date from which data from DSO Billing system should be included into report
dateTo	Date	required	Date to which data from DSO Billing system should be included into report
objectNo	String(20)	not required	Object Number of the object for the supply of electricity in which the contract is concluded.

### 7.5.6.2 JSON Response structure

JSON Response structure			
<pre>{ "count": "number" }</pre>			
Attribute	type	obligation	description
count	number(10)	required	Returns number, how many items are in report items list. This response can be used in objects-data-pack report parameters to split data in few response portions (if need pagination)

Below are the error codes and messages. Response codes and response content in case of error:

### 7.5.6.3 Response Error codes

Code	Message	Explanation
1.	Currently accounting data are not complete and it will be generated within 5 working days. You will be informed separately as soon as data will be complete and ready for a use.	-

## 7.6 Object controller

### 7.6.1 POST /gateway/object/my/active/list?first={integer}&count={integer}&sortKey={string}&sortOrder={ASC/DSC}

<b>URL</b>	POST /gateway/object/my/active/list?first={integer}&count={integer}&sortKey={string}&sortOrder={ASC/DSC}
<b>Description</b>	<p>The method is designed to obtain a list of valid objects in the contract according to the selection criteria. The method will be used before performing:</p> <ul style="list-style-type: none"> <li>• owner change process</li> <li>• contract termination process</li> <li>• tariff plan change process</li> </ul>
<b>Parameter</b>	<p><b>URL:</b></p> <ul style="list-style-type: none"> <li>• <b>first</b> - index (starting from 0) of the object that must be presented first in the return list. Optional. The default value is 0.</li> <li>• <b>count</b> - number of objects in the return list. Optional. The default value is 30.</li> <li>• <b>sort</b> - possible value ASD,DSC.</li> </ul> <p>The data of the JSON form request are presented in the HTTP request body (<b>BODY</b>) (Query JSON structure, below).</p>
<b>Header</b>	After decrypting the supplier authentication key, the supplier ID is used to select the data.
<b>Request</b>	<pre>{   "personCode": "string",   "consumerCode": "string",</pre>

	<pre>"objectNumber": "string", "meterNumber": "string", "showObjectMeter": "boolean", "showObjectPower": "boolean", "showObjectState": "boolean" }</pre>		
<b>Response HTTP code</b>	<b>HTTP status code</b>	<b>Reason</b>	<b>Description</b>
	200	OK	Request completed successfully.
	204	No content	No data found according to the given parameters.
	400	Bad request	Request error. The HTTP response body provides a list of errors in JSON format. ( <i>Error response of the JSON structure below</i> ).
	401	Unauthorized	An attempt was made to connect to a non-public method that requires authentication, but no user credentials were provided.
	403	Forbidden	According to the access control policy, the current user does not have access to perform the requested action.
	404	Not found	Either there is no API method associated with the request URL path, or the request contains one or more parameters that did not return the data.
<b>Response</b>	<pre>[ { "objectNumber": "string", "objectAddress": "string", "objectName": "string", "objectType": "string", "timeLimitedObjectValidTo": "datetime", "ownershipDocumentNumber": "string", "ownershipDocumentDate": "date", "auctionDate": "date", }</pre>		

```

"technologicalCosts":"boolean",
"productsAmount":"integer",
"scalesAmount":"integer",
"metersAmount":"integer",
"autoMetersAmount":"integer",
"supplier":{
  "supplierType":"string",
  "contractStart":"date",
  "contractEnd":"date",
  "contractModel":"string"
},
"objectStates":[
{
  "stateType":"string",
  "state":"string",
  "stateValidFrom":"date",
  "stateValidTo":"date"
}
],
"voltage":"double",
"powerPlantType":"string"
"objectPowers":[
{
  "powerType":"string",
  "power":"double",
  "reliabilityCategoryType":"string",
  "powerValidFrom":"date",
  "powerValidTo":"date"
}
],
"generatingObject":{
  "generatingObjectType":"string",
  "payoffMethod":"string",
  "generatingObjectTypeFrom":"date",
  "generatingObjectTypeTo":"date"
},
"tariff":{
  "tariffPlan":"string",
  "timeZone":"string",
  "tariffPlanChangeDate":"date"
},

```

```
"meters":[
  {
    "meterNumber":"string",
    "meterTypeName":"string",
    "meterScaleLength":"number",
    "conversionPoss":"boolean",
    "meterAutomated":"boolean"
  }
],
"contract":{
  "consumerCode":"string",
  "contractType":"string",
  "personName":"string",
  "personSurname":"string",
  "personCode":"string",
  "personType":"string",
  "personIndividual":"boolean",
  "contact":{
    "mobPhoneNoNetwork":"string",
    "mobPhoneNo2Network":"string",
    "mobPhoneInvoice":"string",
    "phoneNoNetwork":"string",
    "emailNetwork":"string",
    "email2Network":"string",
    "emailInvoice":"string",
    "correspondenceAddress":"string",
    „mobPhoneNoObject“:"string"
  }
}
}
```

**Error response**

```
{
  "errorMessages": [
    {
      "code": 0,
      "text": "string"
    }
  ]
}
```

Rules	No.	Rule description	Error code	Error message	Attributes
	1.	If an attribute has defined possible values, the value index can be specified by specifying the value of the attribute in the request. Indices of all possible values start from 0.	-	-	-
	2.	One or more request parameters are required.	1001	One or more request parameters are required.	personCode, consumerCode, objectNumber, meterNumber
	3.	No data found according to the given parameters.  The returned set of objects is defined: <ul style="list-style-type: none"> <li>• Only the valid objects of the current supplier must be returned;</li> </ul>	HTTP 204	-	supplyOwnership, contractStart, contractEnd
	4.	The request parameter [ <b>showObjectMeter</b> ] values must be: <ul style="list-style-type: none"> <li>• <b>True</b> or</li> <li>• <b>False</b></li> </ul>	-	-	showObjectMeter
	5.	The request parameter [ <b>showObjectPower</b> ] values must be: <ul style="list-style-type: none"> <li>• <b>True</b> or</li> <li>• <b>False</b></li> </ul>	-	-	
	6.	The request parameter [ <b>showObjectState</b> ] values must be:	-	-	showObjectState

		<ul style="list-style-type: none"> <li>• <b>True</b> or</li> <li>• <b>False</b></li> </ul>			
--	--	--	--	--	--

### 7.6.1.1 JSON Request structure

The table below describes the structure of the JSON response:

No.	Attribute	type	obligation	description
1.	personCode	String(20)	not required	Contract owner / tenant / company code.
2.	consumerCode	String(20)	not required	Contract owner / tenant consumer code.
3.	objectNumber	String(20)	not required	Object number.
4.	meterNumber	String(20)	not required	Meter number.
5.	showObjectMeter	Boolean	not required	Indication of whether meter information should be retrieved.
6.	showObjectPower	Boolean	not required	Indication of whether power information should be retrieved.
7.	showObjectState	Boolean	not required	Indication of whether object status information should be retrieved.

### 7.6.1.2 JSON Response structure

The table below describes the structure of the JSON response:

No	Attribute	type	obligation	description
1	objectNumber	String(20)	required	Object number.
3	objectAddress	String(4000)	required	Full address of the object.
5	objectName	String(200)	not required	Object name.

No	Attribute	type	obligation	description
6	objectType	String(200)	not required	Object type name.
7	timeLimitedObjectValidTo	Date	not required	Expire date of the term object.
8	ownershipDocumentNumber	String(20)	not required	Ownership document number.
9	ownershipDocumentDate	Date	not required	Ownership document date of number.
10	auctionDate	Date	not required	Date of acquisition of the object from the auction.
11	technologicalCosts	Boolean	not required	Indicator or object according to the latest data is accounted for technological costs.
12	productAmount	Number	not required	Products' amounts are counted at the level of the object.
13	scalesAmount	Number	not required	Scales' amounts are counted at the level of the object.
14	metersAmount	Number	not required	Meters' amounts are counted at the level of the object.
15	autoMetersAmount	Number	not required	Automated meters' amounts are counted at the level of the object.
16	supplier: {}			
16.1	supplierType	String(2)	required	<p>Current supplier type. Possible meanings:</p> <ul style="list-style-type: none"> <li>• VT - public supplier;</li> <li>• GT - warranty supplier;</li> <li>• NT - independent supplier.</li> </ul>



No	Attribute	type	obligation	description
16.2	contractStart	Date	required	Start date of entry into force of the object at a supplier. (NT/VT/GT)
16.3	contractEnd	Date	not required	End date of entry into force of the object at a supplier. (NT/VT/GT)
16.4	contractModel	String(10)	required	Contract model of the object at a supplier (NT/VT/GT). Contract model of the current object. Possible meanings: <ul style="list-style-type: none"> <li>• BSS - General contract bills;</li> <li>• 2S2S - Two contracts – Two bills.</li> </ul>
17	objectStates: {}			
17.1	stateType	String(3)	not required	Object state type. Possible meanings: <ul style="list-style-type: none"> <li>• ETB - Supply state;</li> <li>• VBS - Consumption state.</li> </ul>
17.2	state	String	not required	Power supply state of the object. Possible meanings: <ul style="list-style-type: none"> <li>• T - Supply;</li> <li>• P - Disconnected on request;</li> <li>• A - Disconnected under sanction;</li> <li>• R - Limited by sanction.</li> </ul> Power consumption state of the object. Possible meanings: <ul style="list-style-type: none"> <li>• N – Temporarily inactive;</li> <li>• V - Consuming;</li> <li>• A - Alleged.</li> </ul>
17.3	stateValidFrom	Date	not required	Object state valid from.

No	Attribute	type	obligation	description
17.4	stateValidTo	Date	not required	Object state valid to.
18	voltage	Double(5,2)	not required	Object voltage, kV.
19	powerPlantType	String(1)	not required	Type of the power plant. Possible meanings: <ul style="list-style-type: none"> <li>• A - Waist</li> <li>• B - Biomass</li> <li>• H - Hydroelectric</li> <li>• K - Other</li> <li>• S - Solar</li> <li>• T - TEC</li> <li>• V - Wind</li> </ul>
20	objectPowers:[]			
20.1	powerType	String(3)	not required	Object power type. Possible meanings: <ul style="list-style-type: none"> <li>• LOG - Permissible power consumption.;</li> <li>• LGG - Permissible power generation;</li> <li>• IOG - Installed usable power;</li> <li>• IGG - Installed to generate power.</li> </ul>
20.2	power	Double(10,3)	not required	Object power.
20.3	powerValidFrom	Date	not required	Object power valid from.
20.4	powerValidTo	Date	not required	Object power valid to.
20.5	reliabilityCategoryType	String(1)	not required	Type of credibility of supply category. Possible meanings:

No	Attribute	type	obligation	description
				<ul style="list-style-type: none"> <li>• 1 - 1 category;</li> <li>• 2 - 2 category;</li> <li>• 3 - 3 category.</li> </ul>
21	generatingObject: {}			
21.1	generatingObjectType	String(1)	not required	Generating consumer type. Possible meanings: <ul style="list-style-type: none"> <li>• G – GV (Generating consumer);</li> <li>• N – NGV (Distant generating consumer).</li> </ul>
21.2	generatingObjectTypeFrom	Date	not required	Generating consumer type valid from.
21.3	generatingObjectTypeTo	Date	not required	Generating consumer type valid to.
21.4	payoffMethod	String(1)	not required	Generating consumer payoff method. Possible meanings: <ul style="list-style-type: none"> <li>• E – kWh – Recovered el. energy;</li> <li>• G - kW – Power plant installed capacity;</li> <li>• M - kWh ir kW – Mixed;</li> <li>• P - % - Payment percentage.</li> </ul>
22	tariff: {}			
22.1	tariffPlan	String(200)	not required	Tariff plan name.
<del>22.2</del>	<del>tariffPlanCategory</del>	<del>String(200)</del>	<del>not required</del>	<del>Tariff plan category name.</del>
22.3	timeZone	String	not required	Object time zone. Possible meaning:

No	Attribute	type	obligation	description
				<ul style="list-style-type: none"> <li>• 1 - One;</li> <li>• 2 - Two;</li> <li>• VR - One with reactive;</li> <li>• 4 - Four (Smart);</li> <li>• DR - Differentiated with reactive;</li> <li>• N - Not established.</li> </ul>
22.4	tariffPlanChangeDate	Date	not required	Date of the tariff plan change.
23	meters:[]			
23.1	meterNumber	String(20)	required	Object meter number.
23.3	meterTypeName	String	not required	Meter type name.
23.4	meterScaleLength	Number	not required	Maximum number of scale marks installed (programmable) in the meter.
23.5	conversionPoss	Boolean	required	Indication of whether conversion of the total readings of the meter scales is possible.
23.6	meterAutomated	Boolean	required	Indication of whether the meter has automated accounting.
24	contract:{"}			
24.1	consumerCode	String(20)	required	Contract owner consumer code.
24.2	contractType	String(10)	required	Contract type. Possible meanings: <ul style="list-style-type: none"> <li>• SBTS - Household contract;</li> <li>• SKMS - Commercial contract.</li> </ul>
24.3	personName	String(200)	required	Contract owner name / company name.

No	Attribute	type	obligation	description
24.4	personSurname	String(50)	not required	Contract owner surname.
24.5	personCode	String(20)	not required	Contract owner person / company code If the subject is individual, that person code must be encrypted: [*****][person code's 3 last symbols]
24.6	personType	String(10)	required	Contract owner / tenant person type. Possible meaning: <ul style="list-style-type: none"> <li>• FAS - individual;</li> <li>• JAS - Juridical.</li> </ul>
24.7	personIndividual	Boolean	required	Indication of whether the contract owner / tenant is individual person.
25	contact: {}			
25.1	mobPhoneNoNetwork	String(12)	not required	Mobile phone number for network.
25.2	mobPhoneNo2Network	String(12)	not required	Extra mobile phone number for the network.
25.3	phoneNoNetwork	String(12)	not required	Phone number for network.
25.4	mobPhoneInvoice	String(12)	not required	Mobile phone number for invoice. Data has been returned if contract type is SKMS.
25.5	emailNetwork	String(49)	not required	Email address for the network.
25.6	email2Network	String(49)	not required	Extra email address for the network.
26.7	emailInvoice	String(50)	not required	Email address for the invoice.

No	Attribute	type	obligation	description
				Data has been returned if the contract type is SKMS.
26.7	correspondenceAddress	String(4000)	not required	Correspondence address full name.
26.8	mobPhoneNoObject	String(12)	not required	Extra mobile phone number for failures. Data has been returned if the contract type is SKMS.

### 7.6.1.3 Error Response structure

The following table describes the JSON structure in the event of a response error:

No.	Attribute	type	obligation	description
1.	code	number	required	Error code.
2.	text	string(4000)	required	Error message.

### 7.6.2 POST /gateway/object/all/active/list?first={integer}&count={integer}&sortKey={string}&sortOrder={ASC/DSC}

<b>URI</b>	POST /gateway/object/all/active/list?first={integer}&count={integer}&sortKey={string}&sortOrder={ASC/DSC}
<b>Description</b>	<p>The method is to obtain a list of objects at the time of awarding the contract, according to the selection criteria.</p> <p>The method will be used before performing:</p> <ul style="list-style-type: none"> <li>• Owner and supplier change process</li> <li>• Supply change process</li> </ul>
<b>Parameters</b>	<b>URL:</b>

- **changeType**— type of contract type
  - SK— Owner change
  - STK— Owner and supplier change
- **first** - index (starting from 0) of the object that must be presented first in the return list. Optional. The default value is 0.
- **count** - number of objects in the return list. Optional. The default value is 30.
- **sort** - possible values ASC, DSC.

The data of the JSON form request are presented in the HTTP request body (**BODY**) (Query JSON structure, below).

**Header**

After decrypting the supplier authentication key, the supplier ID is used to select the data.

**JSON request**

```
{
  "personCode": "string",
  "consumerCode": "string",
  "objectNumber": "string",
  "meterNumber": "string"
  "objectDataConsentSign": "boolean"
}
```

**Response HTTP code**

HTTP status code	Reason	Description
200	OK	Request completed successfully
204	No Content	No data found according to the given parameters.
400	Bad Request	Request error. The HTTP response body provides a list of errors in JSON format. ( <i>Error response of the JSON structure below</i> ).
401	Unauthorized	An attempt was made to connect to a non-public method that requires authentication, but no user credentials were provided.
403	Forbidden	According to the access control policy, the current user does not have access to perform the requested action.
404	Not Found	Either there is no API method associated with the request URL path, or the request contains one or more parameters that did not return the data.

**JSON  
response**

```
[
{
  "personName": "string",
  "personSurname": "string",
  "personCode": "string",
  "consumerCode": "string",
  "objectNumber": "string",
  "metersAmount": "integer",
  "autoMetersAmount": "integer",
  "smartMeterInstallationDate": "date",
  "meters": [
    {
      "meterNumber": "string",
      "meterAutomated": "boolean",
      "automationSystem": "string"
    }
  ],
  "objectAddress": "string",
  "contractType": "string",
  "contractModel": "string",
  "supplierType": "string",
  "timeLimitedObjectValidTo": "datetime",
  "tariffPlan": "string",
  "timeZone": "string",
  "generatingObjectType": "string",
  "payoffMethod": "string",
  "ownershipDocumentNumber": "string",
  "supplyOwnership": "string",
  "contractStart": "date",
  "contractEnd": "date",
  "objectFutureSuppliers": [
    {
      "supplierCode": "string",
      "supplierName": "string",
      "contractStart": "date",
      "contractEnd": "date"
    }
  ],
},
]
```



	<pre> "powerPlantType": "string", "objectPowers": [   {     "powerType": "string",     "power": "double",      "powerValidFrom": "date",     "powerValidTo": "date"    } ] } ] </pre>				
<b>JSON error response</b>	<pre> {   "errorMessages": [     {       "code": 0,       "text": "string"     }   ] } </pre>				
<b>Rules</b>	<b>No.</b>	<b>Rule description</b>	<b>Error code</b>	<b>Error message</b>	<b>Attributes</b>
	0.	If an attribute has defined possible values, the value index can be specified by specifying the value of the attribute in the request. Indices of all possible values start from 0.	-	-	All attributes with specified values.
	1.	One or more request parameters are required.	1001	One or more request parameters are required.	personCode, consumerCode, objectNumber, meterNumber
	2.	No data found according to the given parameters.  The returned set of objects is defined: <ul style="list-style-type: none"> <li>Valid contract objects of all suppliers' must be returned.</li> </ul>	HTTP 204	-	contract.conclusion_date

	3.	The request parameter [objectDataConsentSign] =TRUE is required.	47	It is mandatory to specify a request parameter in order to obtain consent to see object information.	objectDataConsentSign
	4.	The attribute [objectDataConsentSign] values must be: <ul style="list-style-type: none"> <li>• True or</li> <li>• False.</li> </ul>	-	-	objectDataConsentSign
	5.	A maximum of 500 objects can be specified.	2021	A maximum of 500 objects can be specified.	objectNumbers

#### 7.6.2.1 JSON Request structure

The table below describes the structure of the JSON response:

No.	Attribute	type	obligation	description
1.	personCode	String(20)	not required	Person / company code.
2.	consumerCode	String(20)	not required	Consumer code.
3.	objectNumbers	["string"]	not required	Object number. A maximum of 500 objects can be specified
4.	meterNumber	String(20)	not required	Meter number.
5.	objectDataConsentSign	Boolean	not required	Object data consent sing. True or False.

#### 7.6.2.2 JSON Response structure

The table below describes the structure of the JSON response:

No.	Attribute	type	obligation	description
1.	personName	String(200)	required	Contract owner / tenant name / company name.

No.	Attribute	type	obligation	description
2.	personSurname	String(50)	not required	Contract owner / tenant surname.
3.	personCode	String(20)	not required	Contract owner / tenant person / company code. If the subject is individual, that person code must be encrypted: [*****][person code's 3 last symbols]
4.	consumerCode	String(20)	required	Contract owner / tenant consumer code.
5.	objectNumber	String(20)	required	Object number.
6.	meterAmount	Number	not required	The number of meters is calculated at the object level.
7.	autoMetersAmount	Number	not required	The number of automated meters is calculated at the object level.
8.	smartMeterInstallationDate	Date	not required	Date of installation of the object's smart meter.
9.	meters:[]			
9.1.	meterNumber	String(20)	required	Number of the object meter.
9.2.	meterAutomated	Boolean	required	An indication of whether the meter has automated accounting.
9.3.	automationSystem	String(20)	not required	Automated meter system. Possible values: <ul style="list-style-type: none"> <li>MDM (new MDM system, smart meters)</li> <li>EMCOS (existing EMCOS system, automated meters)</li> <li>NULL</li> </ul>
10.	objectAddress	String(4000)	required	Full title of the object address.
11.	contractType	String(10)	required	Contract type of the current object. Possible meanings: <ul style="list-style-type: none"> <li>SBTS - Household customer;</li> <li>SKMS - Commercial customer.</li> </ul>

No.	Attribute	type	obligation	description
12.	contractModel	String(10)	required	Contract model of the current object. Possible meanings: <ul style="list-style-type: none"> <li>• BSS - General contract bills;</li> <li>• 2S2S - Two contracts – Two bills.</li> </ul>
13.	supplierType	String(2)	not required	Current supplier type. Possible meanings: <ul style="list-style-type: none"> <li>• VT - public supplier;</li> <li>• GT - warranty supplier;</li> <li>• NT - independent supplier.</li> </ul>
14.	timeLimitedObjectValidTo	DateTime	not required	Expiry date of the time-limited object
15.	tariffPlan	String(200)	required	Current tariff plan of the object.
16.	timeZone	String(2)	required	Current time zone of the object. Possible meanings: <ul style="list-style-type: none"> <li>• 1 - One;</li> <li>• 2 - Two;</li> <li>• VR - One with reactive;</li> <li>• 4 - Four (Smart);</li> <li>• DR - Differentiated with reactive;</li> <li>• N - Not established.</li> </ul>
17.	generatingObjectType	String(1)	not required	Generating consumer type. Possible meanings: <ul style="list-style-type: none"> <li>• G – GV (Generating consumer);</li> <li>• N – NGV (Distant generating consumer).</li> </ul>
18.	payoffMethod	String(1)	not required	Current pay of method of the generating consumer. Possible meanings: <ul style="list-style-type: none"> <li>• E – kWh – Recovered electricity;</li> <li>• G - kW – Power plant installed power;</li> <li>• M - kWh and kW – Mixed;</li> <li>• P - % - Payment percentage.</li> </ul>

No.	Attribute	type	obligation	description
19.	ownershipDocumentNumber	String(20)	not required	Ownership document number.
20.	supplyOwnership	String(20)	not required	<p>Possible values:</p> <ul style="list-style-type: none"> <li>• MY - the object belongs to the independent supplier;</li> <li>• NOT_MY - the object does not belong to the independent supplier.</li> </ul> <p>Note:</p> <p>For VT / GT case, the value NOT_MY will always be returned.</p> <p>For NT case, the value will be returned according to whether the supplier initiating the action coincides with the supplier of the object.</p>
21.	contractStart	Date	not required	<p>Contract start date with independent supplier.</p> <p>Returns only if supplyOwnership = MY. Otherwise, NULL is returned.</p>
22.	contractEnd	Date	not required	<p>Contract end date with an independent supplier.</p> <p>Returns only if supplyOwnership = MY. Otherwise, NULL is returned.</p>
23.	powerPlantType	String(1)	not required	<p>Type of the power plant. Possible meanings:</p> <ul style="list-style-type: none"> <li>• A - Waist</li> <li>• B - Biomass</li> <li>• H - Hydroelectric</li> <li>• K - Other</li> <li>• S - Solar</li> <li>• T – TEC</li> <li>• V - Wind</li> </ul>
24.	objectPowers:[]			

No.	Attribute	type	obligation	description
24.1	powerType	String(3)	not required	Object power type. Possible meanings: <ul style="list-style-type: none"> <li>• LOG - Permissible power consumption.;</li> <li>• LGG - Permissible power generation;</li> <li>• IOG - Installed usable power;</li> <li>• IGG - Installed to generate power.</li> </ul>
24.2	power	Double(10,3)	not required	Object power.
24.3	powerValidFrom	Date	not required	Object power valid from.
24.4	powerValidTo	Date	not required	Object power valid to.

### 7.6.2.3 Error Response structure

The following table describes the JSON structure in the event of a response error:

No.	Attribute	type	obligation	description
1.	code	number	required	Error code.
2.	text	string(4000)	required	Error message.

## 7.7 Contract controller

### 7.7.1 POST/gateway/contract/list?first={integer}&count={integer}&sortKey={string}&sortOrder={ASC/DSC}

<b>URL</b>	POST/gateway/contract/list?first={integer}&count={integer}&sortKey={string}&sortOrder={ASC/DSC}		
<b>Description</b>	The method is designed to obtain a list of valid contracts according to the selection criteria.		
<b>Parameter</b>	<p><b>URL:</b></p> <ul style="list-style-type: none"> <li>• <b>first</b> - index (starting from 0) of the object that must be presented first in the return list. Optional. The default value is 0.</li> <li>• <b>count</b> - number of objects in the return list. Optional. The default value is 30.</li> <li>• <b>sort</b> - possible value ASD,DSC.</li> </ul> <p>The data of the JSON form request are presented in the HTTP request body (<b>BODY</b>) (Query JSON structure, below).</p>		
<b>Header</b>	After decrypting the supplier authentication key, the supplier ID is used to select the data.		
<b>Request</b>	<pre>{   "personCode": "string",   "consumerCode": "string",   "objectNumber": "string",   "meterNumber": "string" }</pre>		
<b>Response HTTP codes</b>	<b>HTTP status code</b>	<b>Reason</b>	<b>Description</b>
	200	OK	Request completed successfully.
	204	No Content	No data found according to the given parameters.
	400	Bad Request	Request error. The HTTP response body provides a list of errors in JSON format. ( <i>Error response of the JSON structure below</i> ).
	401	Unauthorized	An attempt was made to connect to a non-public method that requires authentication, but no user credentials were provided..

	403	Forbidden	According to the access control policy, the current user does not have access to perform the requested action.
	404	Not Found	Either there is no API method associated with the request URL path, or the request contains one or more parameters that did not return the data.

**Response**

```
[
  {
    "consumerCode":"string",
    "contractType":"string",
    "personName":"string",
    "personSurname":"string",
    "personCode":"string",
    "personType":"string",
    "personIndividual":"boolean",
    "contact":{
      "mobPhoneNoNetwork":"string",
      "mobPhoneNo2Network":"string",
      "mobPhoneInvoice":"string",
      "phoneNoNetwork":"string",
      "emailNetwork":"string",
      "email2Network":"string",
      "emailInvoice":"string",
      "correspondenceAddress":"string"
    },
    "objects":[
      {
        "objectNumber":"string",
        "objectAddress":"string",
        "contractStart":"date",
        "contractEnd":"date",
        "contractModel":"string",
        "mobPhoneNoObject":"string",
```



	<pre> "meters":[   {     "meterNumber":"string"   } ] } ] </pre>				
<b>Error response</b>	<pre> {   "errorMessages": [     {       "code": 0,       "text": "string"     }   ] } </pre>				
<b>Rule</b>	<b>No.</b>	<b>Rule description</b>	<b>Error code</b>	<b>Error message</b>	<b>Atributai / Attributes</b>
	0	If an attribute has defined possible values, the value index can be specified by specifying the value of the attribute in the request. Indices of all possible values start from 0.	-	-	-
	1.	One or more request parameters are required.	1001	One or more request parameters are required.	objectNumber, consumerCode, personCode, meterNumber
	2.	No data found according to the given parameters. The returned set of objects is defined:	HTTP 204	-	-

		Only valid contract of the current supplier must be returned.			
--	--	---	--	--	--

### 7.7.1.1 JSON Response structure

The table below describes the structure of the JSON response:

No.	Attribute	type	obligation	description
1.	personCode	String(20)	not required	Contract owner / tenant / company code.
2.	consumerCode	String(20)	not required	Contract owner / tenant consumer code.
3.	objectNumber	String(20)	not required	Object number.
4.	meterNumber	String(20)	not required	Meter number.

### 7.7.1.2 JSON Response structure

The table below describes the structure of the JSON response:

No	Attribute	type	obligation	description
1.	consumerCode	String(20)	required	Contract owner consumer code.
2.	contractType	String(10)	required	Contract type. Possible meanings: <ul style="list-style-type: none"> <li>• SBTS - Household contract;</li> <li>• SKMS - Commercial contract.</li> </ul>
3.	personName	String(200)	required	Contract owner name / company name.
4.	personSurname	String(50)	not required	Contract owner surname.
5.	personCode	String(20)	not required	Contract owner person / company code

No	Attribute	type	obligation	description
				If the subject is individual (subject. individual=T), that person code must be encrypted: [*****][person code's 3 last symbols]
6.	personType	String(10)	required	Contract owner / tenant person type. Possible meaning: <ul style="list-style-type: none"> <li>• FAS - individual;</li> <li>• JAS - Juridical.</li> </ul>
7.	personIndividual	Boolean	required	Indication of whether the contract owner / tenant is individual person.
object: {}				
8.	objectNumber	String(20)	required	Object number.
9.	objectAddress	String(4000)	required	Full address of the object.
10.	contractStart	Date	required	Start date of entry into force of the object at a supplier. (NT/VT/GT)
11.	contractEnd	Date	not required	End date of entry into force of the object at a supplier. (NT/VT/GT)
12.	contractModel	String(10)	required	Contract model of the object at a supplier (NT/VT/GT). Contract model of the current object. Possible meanings: <ul style="list-style-type: none"> <li>• BSS - General contract bills;</li> <li>• 2S2S - Two contracts – Two bills.</li> </ul>
13.	mobPhoneNoObject	String(12)	not required	Extra mobile phone for failures. Data has been returned if the contract type is SKMS.
meters: []				
14.	meterNumber	String(20)	required	Object meter number.
contact: {}				

No	Attribute	type	obligation	description
15.	mobPhoneNoNetwork	String(12)	not required	Mobile phone number for network.
16.	mobPhoneNo2Network	String(12)	not required	Extra mobile phone number for the network.
17.	phoneNoNetwork	String(12)	not required	Phone number for network.
18.	mobPhoneInvoice	String(12)	not required	Mobile phone number for invoice. Data has been returned if contract type is SKMS.
19.	emailNetwork	String(49)	not required	Email address for the network.
20.	email2Network	String(49)	not required	Extra email address for the network.
21.	emailInvoice	String(50)	not required	Email address for the invoice. Data has been returned if the contract type is SKMS.
22.	correspondenceAddress	String(4000)	not required	Correspondence address full name.

### 7.7.1.3 Error Response structure

The following table describes the JSON structure in the event of a response error:

No.	Attribute	type	obligation	description
1.	code	number	required	Error code.
2.	text	string(4000)	required	Error message.

## 7.8 Notification contract controller - new

### 7.8.1 POST

**/gateway/notification/contract/list?first={integer}&count={integer}&sortOrder={ASC/DSC}**

<b>URI</b>	POST /gateway/notification/contract/list?first={integer}&count={integer}&sortOrder={ASC/DSC}		
<b>Description</b>	Method to obtain change information of the contract owner / contract owner and supplier / <a href="#">supplier</a> .		
<b>Parameters</b>	<p><b>URL:</b></p> <p><b>first</b> - the index of the notification, which must be the first in the return list (starting from 0). Optional. The default value is 0.  <b>count</b> - the number of notification rows in the return list. Optional. The default value is 30.  <b>sort</b> - possible values ASC, DSC.</p> <p>The data of the JSON form request are presented in the HTTP request body (<b>BODY</b>) (Query JSON structure, below).</p>		
<b>Header</b>	After decrypting the supplier authentication key, the supplier ID is used to select the data.		
<b>JSON request</b>	<pre>{   "personCode": "string",   "objectNumber": "string",   "notificationId": "number",   "contractStartFrom": "datetime",   "contractStartTo": "datetime",   "submittedDateFrom": "datetime",   "submittedDateTo": "datetime",   "status": ["string"],   "userNameSearch": "string",   "changeType": ["string"]   "supplierContractNo": "string",   "objectAddressSearch": "string" }</pre>		
<b>Response HTTP code</b>	<b>HTTP status code</b>	<b>Reason</b>	<b>Description</b>
	200	OK	Request completed successfully

	204	No Content	No data found according to the given parameters.
	400	Bad Request	Request error. The HTTP response body provides a list of errors in JSON format. ( <i>Error response of the JSON structure below</i> ).
	401	Unauthorized	An attempt was made to connect to a non-public method that requires authentication, but no user credentials were provided.
	403	Forbidden	According to the access control policy, the current user does not have access to perform the requested action.
	404	Not Found	Either there is no API method associated with the request URL path, or the request contains one or more parameters that did not return the data.
<b>JSON response</b>	<pre>[   {     "notificationId":"number",     "changeType":"string",     "contractType":"string",     "contractStart":"date",     "supplierContractNo":"string",     "notes":"string",     "userName":"string",     "submittedDate":"dateTime",     "latestStatus":"string",     "errorType":"string",     "correspondenceAddress":{       "addressLine":"string",       "street":"string",       "building":"string",       "housingNo":"string",       "apartment":"string",       "locality":"string",       "eldership":"string",</pre>		

```
    "municipality":"string",
    "county":"string"
  },
  "ownerInfo":{
    "subjectType":"string",
    "personName":"string",
    "personSurname":"string",
    "personCode":"string",
    "birthDate":"date",
    "vatCode":"string",
    "representativeName":"string",
    "representativeSurname":"string",
    "representativeDuty":"string",
    "contacts":{
      "mobPhoneNoNetwork":"string",
      "mobPhoneNo2Network":"string",
      "mobPhoneNoInvoice":"string",
      "telPhoneNoNetwork":"string",
      "emailNetwork":"string",
      "email2Network":"string",
      "emailInvoice":"string"
    }
  },
  "contractNotificationStatus":[
    {
      "status":"string",
      "statusDate":"datetime"
    }
  ],
  "objects":[
    {
      "objectNumber":"string",
```

```

        "objectAddress":"string",
        "contractModel":"string",
        "tariffPlan":"string",
        "timeZone":"string",
        "payoffMethod":"string",
        "objectNtr":"string",
        "objectNtrDate":"date",
        "uniqueRoomNo":"string",
        "ntGetCoownerConsent":"boolean",
        "auctionDate":"date",
        "anotherSupplierContractCancellation":"string",
        "cancelledByAnotherSupplier":"boolean"
    }
],
"oldContractInfo":[
    {
        "contractType":"string",
        "consumerCode":"string",
        "object":{
            "objectNumber":"string",
            "meterNumbers":[string],
            "objectAddress":"string",
            "contractModel":"string",
            "tariffPlan":"string",
            "timeZone":"string",
            "ownershipDocumentNumber":"string",
            "ntGetCoownerConsent":"boolean",
            "auctionDate":"datetime",
            "payoffMethod":"string"
        }
    }
]

```



	<pre> } ] </pre>				
<b>JSON error response</b>	<pre> {   "errorMessages": [     {       "code": 0,       "text": "string"     }   ] } </pre>				
<b>Rules</b>	<b>No.</b>	<b>Rule description</b>	<b>Error code</b>	<b>Error message</b>	<b>Attributes</b>
	0.	If an attribute has defined possible values, the value index can be specified by specifying the value of the attribute in the request. Indices of all possible values start from 0.	-	-	All attributes with specified values.
	1.	No data found according to the given parameters.	HTTP 204	-	-
	2.	One or more request parameters are required.	1001	One or more request parameters are required.	personCode, objectNumber, notificationId
	3.	DateFrom cannot be later than DateTo. Equal can be.	1002	DateFrom cannot be later than DateTo.	dateFrom

### 7.8.1.1 JSON Request structure

The table below describes the structure of the JSON response:

No.	Attribute	type	obligation	description
1.	personCode	String(20)	not required	Person / company code.

No.	Attribute	type	obligation	description
2.	objectNumber	String(20)	not required	Object number.
3.	notificationId	Integer	not required	Notification ID.
4.	contractStartFrom	DateTime	not required	Contract start date from.
5.	contractStartTo	DateTime	not required	Contract start date to.
6.	submittedDateFrom	DateTime	not required	Submitted date from.
7.	submittedDateTo	DateTime	not required	Submitted date to.
8.	status	[String]	not required	Notification status. Possible meanings: <ul style="list-style-type: none"> <li>• P – Submitted</li> <li>• I - Sent</li> <li>• A - Cancelled</li> <li>• V - In progress</li> <li>• IV - Completed</li> <li>• K – Error</li> </ul>
9.	userNameSearch	String(240)	not required	The user who created a notification.
10.	changeTye	[String]	not required	Change type. Possible meanings: SK - Owner change; STK - Owner and supplier change; NTK – <a href="#">Supplier change</a> .
11.	supplierContractNo	String(30)	not required	Supplier contract number.
12.	objectAddressSearch	String(4000)	not required	Object full address.

### 7.8.1.2 JSON Response structure

The table below describes the structure of the JSON response:

No.	Attribute	type	obligation	description
1.	notificationId	Integer	required	Notification ID.
2.	changeType	String(10)	required	Change type. Possible meanings:  SK - Owner change; STK - Owner and supplier change; NTK – Supplier change.
3.	contractType	String(10)	required	Contract type. Possible meanings:  SBTS - Household contract; SKMS - Commercial contract.
4.	contractStart	Date	required	Date of entry into force of the notification subject to the independent supplier from.
5.	supplierContractNo	String(30)	not required	Contract number.  Must be completed and is mandatory only in the change of owner and supplier / <a href="#">change of supplier</a> .
6.	notes	String(4000)	not required	Notes.
7.	userName	String(240)	not required	The user, who created the post.
8.	submittedDate	dateTime	required	Submitted date of notification.
9.	latestSatus	String(10)	required	Latest status of notification.
10.	errorType	String(10)	not required	Notification error type if status=K (Error).  Possible meanings: <ul style="list-style-type: none"> <li>• SP - The contract has already been rewritten</li> <li>• KL - Incorrect message</li> <li>• AG - Invalid person code / birth data</li> <li>• SN - Change of owner is not possible because the data in the old contract does not match</li> </ul>

No.	Attribute	type	obligation	description
				<ul style="list-style-type: none"> <li>• SK - The owner has a contract, the change of owner is not possible for the same person</li> <li>• DL - The owner has a contract, the independent supplier is assigned to the object.</li> <li>• NT - Cancellation at the Supplier's request</li> <li>• NO - client is not the owner of the object</li> </ul> <p>*Will be supplemented by the causes of errors of NTK process.</p>
correspondenceAddress				
11.	addressLine	String(4000)	not required	Not structured full address title.
12.	street	String(200)	not required	Street.
13.	building	String(100)	not required	House.
14.	housingNo	String(100)	not required	Housing.
15.	apartment	String(20)	not required	Flat.
16.	locality	String(200)	not required	Town / Village.
17.	eldership	String(200)	not required	Eldership.
18.	municipality	String(200)	not required	Municipality.
19.	county	String(200)	not required	Country.
ownerInfo				
20.	subjectType	String(10)	required	<p>Contract owner / tenant person type. Possible meanings:</p> <p>FAS - individual; JAS - Juridical.</p>

No.	Attribute	type	obligation	description
21.	personName	String(200)	required	Contract owner / tenant / company name.
22.	personSurname	String(50)	not required	Contract owner / tenant surname.
23.	personCode	String(20)	not required	Contract owner / tenant person / company code
24.	birthDate	Date	not required	Contract owner / tenant birth date.
25.	vatCode	String(15)	not required	Contract owner / tenant VAT code.
26.	representativeName	String(50)	not required	Representative name.
27.	representativeSurname	String(50)	not required	Representative surname.
28.	representativeDuty	String(100)	not required	Representative duty.
ownerInfo.contacts				
29.	mobPhoneNoNetwork	String(12)	not required	Mobile phone number for networks. Contact details for information on network work (accounting maintenance, electrical disconnections and faults).
30.	mobPhoneNo2Network	String(12)	not required	Mobile phone number 2 for networks. Contact details for information on network work (accounting maintenance, electrical disconnections and faults).
31.	mobPhoneNoInvoice	String(12)	not required	Mobile phone number for bills. Contact details for informing about formed invoices and provided services.
32.	telPhoneNoNetwork	String(12)	not required	Phone number for networks. Contact details for information on network work (accounting maintenance, electrical disconnections and faults).
33.	emailNetwork	String(49)	not required	An email address for networks. Contact details for information on network work (accounting maintenance, electrical disconnections and faults).

No.	Attribute	type	obligation	description
34.	email2Network	String(49)	not required	An email address 2 for networks. Contact details for information on network work (accounting maintenance, electrical disconnections and faults).
35.	emailInvoice	String(100)	not required	An email address for bills. Contact details for informing about formed invoices and provided services.
contractNotificationStatus(Status of the contract change notification)				
36.	status	String(10)	required	Notification status. Possible meanings: P – Submitted I - Sent A - Cancelled V - In progress IV - Completed K - Error.
37.	statusDate	DateTime	required	Status date.
objects[]				
38.	objectNumber	String(20)	required	Object number.
39.	objectAddress	String(4000)	required	Object address.
40.	contractModel	String(10)	required	Contract model of the current object. Possible meanings: BSS - General contract bills; 2S2S - Two contracts – Two bills.
41.	tariffPlan	String(200)	not required	Chosen tariff plane of the object.
42.	timeZone	String(2)	not required	Current time zone of the object. Possible meanings: 1 - One; 2 - Two; VR - One with reactive;

No.	Attribute	type	obligation	description
				4 - Four (Smart); DR - Differentiated with reactive; N - Not established.
43.	payoffMethod	String(1)	not required	Chosen pay of method of the generating consumer. Possible meanings:  E – kWh – Recovered electricity; G - kW – Power plant installed power; M - kWh and kW – Mixed; P - % - Payment percentage.
44.	objectNtr	String(20)	not required	Real estate cadaster and register number of the object of the State Enterprise Registers Center.
45.	objectNtrDate	Date	not required	Date of the Real estate cadaster and register number of the object of the State Enterprise Register Center.
46.	uniqueRoomNo	String(20)	not required	Unique room number.
47.	ntGetCoownerConsent	Boolean	required	Indication of whether the independent supplier has obtained the consent of the co-owner. Possible meanings:  <ul style="list-style-type: none"> <li>• True</li> <li>• False</li> </ul>
48.	auctionDate	Date	not required	Date of acquisition of the object from the auction.
49.	anotherSupplierContractCancellation	String(4000)	not required	The field is filled in when contracts with another supplier are canceled with this notification. "Ši užklausa atšauké objekto sutartį su [independentSupplierName] datai [contractStart]"
50.	cancelledByAnotherSupplier	boolean	not required	The field is filled in if the object of the notification was canceled with a notification from another supplier. Possible meanings: <ul style="list-style-type: none"> <li>• True - "Ši objekto sutartis atšaukta kito tiekėjo"</li> <li>• False</li> </ul>
oldContractInfo[]				

No.	Attribute	type	obligation	description
51.	contractType	String(10)	required	Contract type of the current object. Possible meanings: <ul style="list-style-type: none"> <li>• SBTS - Household customer;</li> <li>• SKMS - Commercial customer.</li> </ul>
52.	consumerCode	String(20)	required	Consumer code.
oldContractInfo.object				
53.	objectNumber	String(20)	required	Object number.
54.	meterNumbers	String(200)	not required	Object meter (meters).
55.	objectAddress	String(4000)	required	Object address.
56.	contractModel	String(10)	required	Contract model of the current object. Possible meanings: <p>BSS - General contract bills; 2S2S - Two contracts – Two bills.</p>
57.	tariffPlan	String(200)	required	Tariff plan of the object.
58.	timeZone	String(2)	required	Current time zone of the object. Possible meanings: <p>1 - One; 2 - Two; VR - One with reactive; 4 - Four (Smart); DR - Differentiated with reactive; N - Not established.</p>
59.	ownershipDocumentNumber	String(20)	not required	Ownership document number.
60.	ntGetCoownerConsent	Boolean	required	Indication of whether the independent supplier has obtained the consent of the co-owner. Possible meanings: <p>True False</p>



No.	Attribute	type	obligation	description
61.	auctionDate	DateTime	not required	Date of acquisition of the object from the auction.
62.	payoffMethod	String(1)	not required	Pay of method of the generating consumer. Possible meanings:  E – kWh – Recovered electricity; G - kW – Power plant installed power; M - kWh and kW – Mixed; P - % - Payment percentage.

### 7.8.1.3 Error Response structure

The following table describes the JSON structure in the event of a response error:

No.	Attribute	type	obligation	description
1.	code	number	required	Error code.
2.	text	string(4000)	required	Error message.

### 7.8.2 POST /gateway/notification/contract

<b>URI</b>	<a href="#">POST /gateway/notification/contract</a>
<b>Description</b>	The method is for NT to transfer contract owner / contract owner and supplier / <a href="#">supplier changes</a> to DataHub.
<b>Parameters</b>	<b>URL:</b>  The data of the JSON form request are presented in the HTTP request body ( <b>BODY</b> ) (Query JSON structure, below).
<b>Header</b>	After decrypting the supplier authentication key, the supplier ID is used to select the data.

**JSON  
request**

```
{
  "changeType": "string",
  "contractType": "string",
  "contractStart": "date",
  "consentSign": "boolean",
  "supplierContractNo": "string",
  "notes": "string",
  "correspondenceAddress":
  {
    "street": "string",
    "building": "string",
    "housingNo": "string",
    "appartement": "string",
    "locality": "string",
    "eldership": "string",
    "municipality": "string",
    "county": "string"
  },
  "ownerInfo":
  {
    "subjectType": "string",
    "personName": "string",
    "personSurname": "string",
    "personCode": "string",
    "birthDate": "date",
    "vatCode": "string",
    "representativeName": "string",
    "representativeSurname": "string",
    "representativeDuty": "string",
    "contacts":
    {
      "mobPhoneNoNetwork": "string",
```

```

        "mobPhoneNo2Network": "string",
        "mobPhoneNoInvoice": "string",
        "telPhoneNoNetwork": "string",
        "emailNetwork": "string",
        "email2Network": "string",
        "emailInvoice": "string"
    }
},
"objects": [
    {
        "objectNumber": "string",
        "tariffPlan": "string",
        "contractModel": "string",
        "timeZone": "string",
        "payoffMethod": "string",
        "objectNtr": "string",
        "objectNtrDate": "date",
        "uniqueRoomNo": "string",
        "ntGetCoownerConsent": "boolean",
        "auctionDate": "date"
    }
]
}

```

Response HTTP code	HTTP status code	Reason	Description
	201	Created	Request completed successfully
	400	Bad Request	Request error. The HTTP response body provides a list of errors in JSON format. ( <i>Error response of the JSON structure below</i> ).
	401	Unauthorized	An attempt was made to connect to a non-public method that requires authentication, but no user credentials were provided.

	403	Forbidden	According to the access control policy, the current user does not have access to perform the requested action.					
	404	Not Found	Either there is no API method associated with the request URL path, or the request contains one or more parameters that did not return the data.					
<b>JSON response</b>	<pre>{   "notificationId": "number" }</pre>							
<b>JSON error response</b>	<pre>{   "errorMessages": [     {       "code": 0,       "text": "string"     }   ] }</pre>							
<b>Rules</b>	<b>No.</b>	<b>Rule description</b>	<b>*SK</b>	<b>**STK</b>	<b>***NTK</b>	<b>Error code</b>	<b>Error message</b>	<b>Attributes</b>
<p>*SK - the relevant rule for change of owner</p> <p>**STK - the relevant rule for change of owner and supplier</p> <p>***NTK – the relevant rule for change of supplier</p>								
	0.	If an attribute has defined possible values, the value index can be specified by specifying the value of the attribute in the request. Indices of all possible values start from 0.	+	+	+	-	If an attribute has defined possible values, the value index can be specified by specifying the value of the attribute in the request. Indices of all possible values start from 0.	-
	1.	Time-limited objects cannot be changed if they are expired.  Ex.: If the time-limited object expiry date is 12-20 and the current date is	+	+	-	5	Change not possible. Time-limited objects: <b>[objectNumber (if there is more than one object, objects</b>	object.time_limited_object_vali d_to, object.object_number, object.object_id,

	<p>12-20 then 12-20=12-20 → the system displays error message;</p> <p>Ex.: If the time-limited object expiry date is 12-20 and the current date is 12-22 then 12-20&lt;12-22 → the system displays error message;</p> <p>Ex.: If the time-limited object expiry date is 12-21 and the current date is 12-20 then 12-21&gt;12-20 → there is no error.</p>					<p><b>must be separated by the semicolon)]</b> are expired.</p>	objectNumber
2.	Submitted object cannot have the same / matching meters numbers.	+	+	+	6	<p>Change not possible. Objects: <b>[objectNumber (if there is more than one object, objects must be separated by the semicolon)]</b> have the same / matching meter number.</p>	object_meter.meter_number, object_meter.valid_from, object_meter.valid_to, object.object_number, object.object_id, objectNumber
3.	The attribute <b>[ObjectNumber]</b> is mandatory.	+	+	+	-	-	objectNumber
4.	The meaning of the <b>[ObjectNumber]</b> notification cannot be repeated.	+	+	+	7	<p>The object: <b>[objectNumber (if there is more than one object, objects must be separated by the semicolon)]</b> is repeating.</p>	objectNumber
5.	Must be specified valid object.	+	+	+	8	<p>The object: <b>[objectNumber (if there is more than one object, objects must be separated by</b></p>	objectNumber

						the semicolon)] not found in the system.	
6.	If <b>changeType=SK</b> , then the object must belong to a valid supplier contract that provides the notification and the object must have at least one valid meter.	+	-	-	9	The object: <b>[objectNumber (if there is more than one object, objects must be separated by the semicolon)]</b> does not belong to a valid supplier contract.	objectNumber, independentSupplierId, independent_supplier_objects. valid_from independent_supplier_objects. valid_to contract.conclusion_date
7.	The attribute <b>[subjectType]</b> meaning must be:  - <b>FAS</b> or - <b>JAS</b> .	+	+	+	-	-	subjectType
8.	The attribute <b>[contractType]</b> meaning must be:  - <b>SBTS</b> or - <b>SKMS</b> .	+	+	+	-	-	contractType
9.	If the attribute <b>[subjectType] = JAS</b> , the attribute <b>[contractType]</b> meaning must be equal to <b>SKMS</b> .	+	+	+	10	If the contract owner / tenant person type is "Juridical", the contract type must be "SKMS"	subjectType, contractType
9.1.	If the attribute <b>[changeType] = NTK</b> , the values of the attribute <b>[contractType]</b> and <b>[subjectType]</b> must match the current contract type of the object and the person type of the owner.	-	-	+	129	The contract type and the contract owner's person type must match the current contract type and the contract owner type.	contractType, subjectType, changeType
10.	If <b>changeType=SK/STK</b> , then the attribute <b>[contractStart]</b> can be equal	+	+	-	11	Date of the contract start <b>[contractStart]</b> can	contractStart, objectNumber, changeType

	<p>to the current date or later than current.</p> <p>Ex.: If the current date is 2021-02-08 , then [contractStart] start date can be any date inclusive from 2021-02-08 to X date in the future.</p>					be equal to the current date or later then current.	
10.1.	If <b>changeType=NTK</b> , then the attribute <b>[contractStart]</b> must be equal to the first day of the month.	-	-	+	111	Date of the contract start <b>[contractStart]</b> must be equal to the first day of the month.	contractStart, objectNumber, changeType
11.	<del>If <b>changeType=NTK</b>: during the submission of the notification, it is checked whether a contract for another or the same real estate has not been concluded for the object from a later date than the date of entry into force of the contract. If the contract for the object has already been concluded, an error message must occur and the date of submission of the concluded contract shall be indicated.</del>	-	-	+	112	<del>An information of the conclusion of the contract since <b>[independent_supplier_object.valid_from]</b> has already been submitted to the object <b>[objectNumber]</b>.</del>	contractStart, objectNumber, changeType
12.	<p>If <b>changeType=NTK</b>, it is checked whether the date of entry into force of the contract is given correctly:</p> <p>Notifications of the concluded contract must be submitted by the day of the month specified in the configuration, and the contract may enter into force</p>	-	-	+	113	The effective date of the contract must not be less than <b>[date]</b> .	contractStart, objectNumber, changeType

	<p>at the earliest from the first day of the following month.</p> <p>Ex.: configuration date is 18 d.</p> <p>current date 2021-09-17 this is the earliest contract that can be concluded on October 1.</p> <p>current date 2021-09-20 this is the earliest contract that can be concluded on November 1.</p>						
13.	<p>If <b>changeType=NTK</b>: when submitting a new supplier change notification, the system must be checked for the presence of supplier change notification with a status not Canceled and not Error.</p>	-	-	+	116	<p>Due to possible duplication of information, such a notification to object <b>[objectNumber]</b> is not possible. Please try after 30 minutes.</p>	<p>contractStart, objectNumber, changeType</p>
14.	<p>If <b>changeType=NTK</b>, then a change of supplier notice shall not be permitted if a change of owner and supplier notice is in progress. It should not be allowed only if the object number and the date of contract start force of the contract coincide in the notifications.</p>	-	-	+	117	<p>For object <b>[object number (if more than one is separated by a semicolon)]</b>, a change of supplier is already in progress with the owner and supplier change request</p>	<p>contractStart, objectNumber, changeType</p>
15.	<p>In the context of the object, one irrevocable / infallible change of owner (<b>SK</b>) / owner and supplier (<b>STK</b>) request is possible for the same contract entry date. Another request can be submitted from the day following the entry into force of the latest request agreement found.</p>	+	+	-	12	<p>The request to change owner / owner and supplier for objects <b>[objectNumber (if more than one is separated by a semicolon)]</b> has already been submitted.</p>	<p>objectNumber, contract_object_change_notification.object_number, contractStart, contract_object_change_notification.contract_start, changeType=SK,</p>



- If the object X does not have the notification of the owner / owner and supplier in the system with the status "Įvykdytas" / "Vykdomas" / "Pateiktas" / "Išsiųstas", then:
- The contract start date for the new notification must be chosen from the current day to X date in the future.
  - ex.: current date 2021-05-12, then the notification date can be 2021-05-12 to X date in the future;
- If the object X has the notification of the owner / owner and supplier in the system with the status "Įvykdytas" / "Vykdomas" / "Išsiųstas" / "Pateiktas", then:
- The latest date of entry into force of the contract from the notification must be checked AND
- the notification may be submitted from the date of entry into force of the latest notification contract found from the following day to X date in the future.
  - ex.: current 2021-05-12, found a message for the date 2021-05-14, and a message for the date 2021-05-21, this can provide dates from 2021-05-22 to X date in the future;

contract\_change\_notification.c  
 hange\_type=SK,  
 contract\_change\_status.status  
 =Priimtas

	<ul style="list-style-type: none"> <li>ex.: current 2021-05-12, found a message for the date 2021-05-14 and a message for the date 2021-06-01, this message can provide dates from 2021-06-02 to X date in the future.</li> </ul>						
16.	The attribute <b>[contractStart]</b> format must be: yyyy-mm-dd. yyyy - year; mm - month; dd - day.	+	+	+	-	-	contractStart
17.	Mandatory attributes are: <ul style="list-style-type: none"> <li>[subjectType] and</li> <li>[contractType] and</li> <li>[contractStart].</li> </ul>	+	+	+	-	-	subjectType, contractType, contractStart
18.	If the attribute <b>[changeType]=STK/NTK</b> then mandatory attribute is:  - [supplierContractNo]	-	+	+	14	"Contract No." is mandatory.	supplierContractNo
19.	The <b>[contractModel]</b> attribute must be:  - <b>BSS</b> or - <b>2S2S</b> .	+	+	+	-	-	contractModel, changeType
20.	If the attribute <b>[contractType]=SBTS</b> then meaning of the <b>[contractModel]</b> attribute must be equal to <b>BSS</b> .	+	+	+	16	If the contract type is equal to "SBTS" then the contract model must be "BSS".	contractType, contractModel

21.	If the attribute <b>[changeType]=NTK</b> , <b>[contractType]=SBTS</b> , It is possible to change the tariff plan of the object, if the possible date of changing the tariff plan is earlier than or equal to the date of "Contract start".	-	-	+	131	Change not possible. The object: <b>[objectNumber]</b> possible tariff plan change [date] date is later than the date of contract start.	tariffPlan, changeType, contractType, objectnumber
22.	If <b>changeType=STK/NTK</b> , then the object may be included in no more than one contract with the supplier, which indicates the same date of entry into force of the contract.	-	+	-	108	An information of the conclusion of the contract with <b>[independent_supplier.name]</b> since <b>[independent_supplier_object.valid_from]</b> has already been submitted to the object <b>[objectNumber]</b> .	changeType, objectNumber, independent_supplier_object
23.	If the attribute <b>[subjectType]=FAS</b> then the mandatory attributes are:  - [personName] and - [personSurname] and - [personCode] or [birthDate].	+	+	+	18	If the person type of the contract owner / tenant is "Physical", the "Name" and "Surname" and "Personal identification code" or "Date of birth" are mandatory.	personName, personSurname, personCode, birthDate, subjectType
24.	If the attribute <b>[subjectType]=JAS</b> then the mandatory attributes are:  - [personName] and - [personCode].	+	+	+	19	If the person type of the contract owner / tenant is "Juridical", then "Company Name" and "Company Code" are mandatory.	personName, personCode, subjectType
25.	The attribute <b>[birthDate]</b> format must be: yyyy-mm-dd. yyyy - year; mm - month; dd - day.	+	+	+	-	-	birthDate

26.	<p>If <b>changeType=SK/STK/NTK</b> and if the attribute <b>[contractType] = SBTS</b>, then must be at least one contact attribute:</p> <ul style="list-style-type: none"> <li>• [mobPhoneNoNetwork] or</li> <li>• [telPhoneNoNetwork] or</li> <li>• [emailNetwork].</li> </ul>	+	+	+	20	<p>If the contract type is "SBTS", it is mandatory to specify at least one attribute for network work: "Mobile phone no." or "Phone no." or "Email address".</p>	<p>mobPhoneNoNetwork, emailNetwork, contractType, <a href="#">changeType</a></p>
27.	<p>If changeType=SK/STK/NTK and attribute <b>[contractType] = SKMS</b> then must be at least one contact attribute:</p> <p>- [mobPhoneNoNetwork] or - [telPhoneNoNetwork] or - [emailNetwork].</p> <p>and <b>at least one</b> contact attribute of the bills from:</p> <p>- [mobPhoneNoInvoice] <b>or</b> - [emailInvoice].</p>	+	+	+	21	<p>If the contract type is "SKMS", it is mandatory to specify one of the contacts for network work: "Mobile phone no." or "Phone no." or "Email Address" and <b>one of</b> the contact for accounts: "Mobile Phone no." <b>or</b> "Email Address".</p>	<p>mobPhoneNoNetwork, telPhoneNoNetwork, emailNetwork, mobPhoneNoInvoice, emailInvoice, contractType, changeType</p>
28.	<p>The format of the attributes <b>[mobPhoneNoNetwork]</b>, <b>[mobPhoneNo2Network]</b>, <b>[mobPhoneNoInvoice]</b> must be : +3706XXXXXXXX, X - an integer (0 must be included)</p> <p>The format of the attribute <b>[telPhoneNoNetwork]</b> must be : +370XXXXXXXX, X - an integer (0 must be included)</p>	+	+	+	22	<p>Mob. tel. No., mob. tel. No. (optional) and phone no. incorrect format.</p>	<p>mobPhoneNoNetwork, mobPhoneNo2Network, telPhoneNoNetwork, mobPhoneNoInvoice</p>
29.	<p>The format of the attributes <b>[emailNetwork]</b>, <b>[email2Network]</b>, <b>[emailInvoice]</b> must be</p>	+	+	+	23	<p>An email address, optional email address and invoice email address incorrect format.</p>	<p>emailNetwork, email2Network, emailInvoice</p>

	[text][@][text][.domain], letters in the text must be Latin. Can be at most 49 characters up to @ symbol.						
30.	If <b>changeType=SK/STK</b> , then in the context of an object, one irrevocable / infallible change of owner / owner and supplier change request is possible for the same owner. The current contract owner cannot match the newly submitted owner.	+	+	-	24	The owner [personName personSurname (personSurname is displayed if subjectType = FAS)] has already been queried or the owner coincides with the owner of the current contract.	subjectType, personSurname, personName, personCode, birthDate, contractStart
30.1.	If <b>changeType = NTK</b> , then in the context of the object, the provided owner must match the owner of the current contract.	-	-	+	121	The owner [personName personSurname (personSurname is displayed if subjectType = FAS)] does not match the owner of the current contract. Request a change of owner and supplier.	changeType, personCode, personName, personSurname, birthDate
31.	If the attribute <b>[contractType] = SBTS</b> , then the meaning of the <b>[tariffPlan]</b> attribute must be:  - Namai or - Namai plius or - Standartinis or - Išmanusis or - Vidutinė įtampa.	+	+	+	27	If the contract type is SBTS, then the tariff plan must be "Namai" / "Namai plius" / "Standartinis" / "Išmanusis" / "Vidutinė įtampa".	tariffPlan, contractType
32.	If the attribute <b>[changeType]=SK/STK</b> and <b>[contractType] = SBTS</b> , then the mandatory attributes are:	+	+	-	28	If the contract type is "SBTS", it is mandatory to indicate "Tariff Plan" and "Time Zone".	tariffPlan, timeZone, contractType

	- [tariffPlan] and - [timeZone].						
32.1.	If the attribute <b>[changeType]=NTK</b> , <b>[contractType] = SBTS</b> and if at least one attribute is specified:  - <b>[tariffPlan]</b> or  - <b>[timeZone]</b>  Then both must be specified.	-	-	+	122	If the contract type is "SBTS" and "Tariff Plan" or "Time Zone" is specified, then both must be specified.	tariffPlan, timeZone, contractType
33.	If the attribute <b>[contractType] = SBTS</b> and attribute <b>[tariffPlan] = Išmanysis</b> , then the attribute <b>[timeZone]</b> meaning must be: <ul style="list-style-type: none"><li>• 4.</li></ul>	+	+	+	29	If the contract type is SBTS and the tariff plan is "Išmanysis", then the time zone must be "4 (Smart)".	timeZone, contractType, tariffPlan
34.	If the attribute <b>[contractType] = SBTS</b> and attribute <b>[tariffPlan] = Namai / Namai plius / Standartinis / Vidutinė įtampa</b> , then the attribute <b>[timeZone]</b> meaning must be:  - 1 or - 2.	+	+	+	30	If the contract type is SBTS and the tariff plan is "Namai" or "Namai plius" or "Standartinis" or "Vidutinė įtampa", then the time zone must be One or Two.	timeZone, contractType, tariffPlan
35.	The meaning of the <b>[ntGetCoownerConsent]</b> attribute must be:  - <b>True</b> or - <b>False</b> .	+	+	-	-	-	ntGetCoownerConsent

36.	The format of the <b>[auctionDate]</b> attribute must be: yyyy-mm-dd, yyyy - years, mm - month, dd - day.	+	+	-	-	-	auctionDate
37.	The format of the <b>[ObjectNtrDate]</b> attribute must be: <b>yyyy-mm-dd</b> , yyyy - years, mm - month, dd - day.	+	+	-	-	-	objectNtrDate
38.	The meaning of the <b>[payoffMethod]</b> attribute must be:  - E or - G or - P.	+	+	+	-	-	payoffMethod
39.	If the attribute <b>[objectNtr]</b> is filled then the <b>[objectNtrDate]</b> attribute is mandatory.	+	+	-	31	If the Real estate cadaster and register of the State Enterprise Centre of Registers object is filled in, the Real estate cadaster and register date of the State Enterprise Centre of Registers object must be indicated.	objectNtr, objectNtrDate
40.	The meaning of the <b>[consentSign]</b> must be:  - <b>True</b> or - <b>False</b> .	+	+	+	-	-	consentSign
41.	If the attribute <b>[consentSign] = False</b> , then the modification must be disabled.	+	+	+	32	It is necessary to confirm that the data provided is correct.	consentSign

42.	Upon successful creation of a change of owner / owner and supplier / <a href="#">supplier</a> request, the status of the request becomes "Submitted".	+	+	+	-	-	contract_change_status.status, contract_change_status.status_date
43.	Meaning of the mandatory attribute [ <b>changeType</b> ] must be: <ul style="list-style-type: none"> <li>• <b>SK</b> or</li> <li>• <b>STK</b> or</li> <li>• <b>NTK</b></li> </ul>	+	+	+	-	-	changeType
44.	The supplier will be identified by the authentication key.	+	+	+	1003	The independent supplier cannot be found in the system or supplier is not active.	independent_supplier.id, contract_change_notification.independent_supplier_id
45.	The [ <b>contractModel</b> ] attribute is mandatory.	+	+	+	-	-	contractModel, changeType
46.	The attribute [ <b>contractModel</b> ] must match for all objects.	+	+	+	148	The contract model must match for all objects.	objectNumber, contractModel
47.	If attribute <b>changeType=NTK</b> , then the attributes must not be specified: <ul style="list-style-type: none"> <li>• <b>objectNtr</b></li> <li>• <b>objectNtrDate</b></li> <li>• <b>auctionDate</b></li> <li>• <b>ntGetCoownerConsent</b></li> <li>• <b>uniqueRoomNo</b></li> </ul>	-	-	+	130	If the change type is "Supplier change", the attributes must not be specified: "Object ntr", "Object ntr date", "Auction date", "NT get coowner consent", "Unique room No.".	objectNtr, objectNtrDate, auctionDate, ntGetCoownerConsent, uniqueRoomNo, changeType
48.	If the attribute [ <b>contractType</b> ] = <b>SBTS</b> , must be specified valid [ <b>tariffPlan</b> ].	+	+	+	35	There is no tariff plan [ <b>tariffPlan (if there is more than one object, objects must be</b>	tariffPlan, tariff_plan_category.tariff_plan_category_id, contract_object_change_notification.tar



							<b>separated by the semicolon)].</b>	iff_plan_category_id, contractType
49.	The value of attribute <b>[birthDate]</b> cannot be later than the current date.	+	+	+	37	A birth date cannot be later than the current date.		birthdate
50.	If the attribute <b>[objectNtrDate]</b> is filled then the <b>[objectNtr]</b> attribute is mandatory.	+	+	+	38	If date of the Real estate cadaster and register number of the object of the State Enterprise Register is filled, the Real estate cadaster and register number of the object of the State Enterprise Registers Center must be included.		objectNtr, objectNtrDate
51.	<del>If the attribute <b>[changeType]=SK</b> then attribute <b>[supplierContractNo]</b> cannot be filled.</del>	+	-		39	<del>If the contract type "SK", then supplier contract No. cannot be filled.</del>		<del>changeType, supplierContractNo</del>
52.	If <b>changeType=SK/STK/NTK</b> and If the attribute <b>[contractType]=SBTS</b> then attributes <b>[mobPhoneNoInvoice]</b> and <b>[emailInvoice]</b> cannot be filled.	+	+	+	41	If the contract type "SBTS", then invoice mob. tel. No. and invoice email address cannot be filled.		contractType, mobPhoneNoInvoice, emailInvoice
53.	The attribute <b>[payoffMethod]</b> cannot be field if consumer type is not generating consumer <b>[generatingObjectType is not G]</b> or <b>[contractType is not SBTS]</b> .	+	+	+	42	Generating consumer payoff method cannot be field, if consumer type is not generating consumer or contract type is not SBTS.		payoffMethod, generatingObjectType

54.	The attribute <b>[timeZone]</b> must be: <ul style="list-style-type: none"> <li>• 1;</li> <li>• 2;</li> <li>• VR;</li> <li>• 4;</li> <li>• DR.</li> </ul>	+	+	+	-	-	timeZone
55.	All objects of the notification must belong to the same contract.	+	+	+	43	Change not possible. Different contracts for submitted objects.	objectNumber, consumerCode
56.	If the attribute <b>[subjectType]</b> = FAS, then the attribute <b>[personCode]</b> must be 11 digits.  If the attribute <b>[subjectType]</b> = JAS, then the attribute <b>[personCode]</b> must be 9 digits.	+	+	+	44	The personal code must consist of 11 digits, the company code - 9 digits.	subjectType, personCode
57.	If the attribute <b>[subjectType]</b> = JAS, then the attributes <b>[birthDate]</b> and <b>[personSurname]</b> cannot be specified.	+	+	+	45	If the contract owner / tenant person type is "Juridical", the birth date and surname cannot be specified.	subjectType, birthDate, personSurname
58.	If the attribute <b>[subjectType]</b> = FAS, then the attribute <b>[personName]</b> must be up to 50 symbols.	+	+	+	46	If the contract owner / tenant person type is "Individual", the name must be up to 50 symbols.	subjectType, personName
59.	If the attribute <b>[contractType]</b> = SKMS and at least one of the attributes <b>[representativeName]</b> ,	+	+	+	141	If the contract type is "SKMS" and at least one attribute of the	contractType, representativeName,

	[representativeSurname], [representativeDuty] is specified, all three attributes must be filled in.					representative is specified, all three attributes must be indicated: "Representative name", "Representative surname", "Representative duty".	representativeSurname, representativeDuty
65.	If the attribute [contractType] = SBTS, then the attributes [representativeName], [representativeSurname] and [representativeDuty] cannot be specified.	+	+	+	147	If the contract type is "SBTS", the name, surname and the duty of the representative cannot be specified.	contractType, representativeName, representativeSurname, representativeDuty
66.	If the attribute [contractType] = <b>SBTS</b> and the current tariff plan of object is "Vidutinė įtampa", then the new [tariffPlan] must be "Vidutinė įtampa".	+	+	+	48	If the contract type is "SBTS" and the current tariff plan of object [objectNumber] is "Vidutinė įtampa", then the new tariff plan must be "Vidutinė įtampa"	tariffPlan, contractType
67.	If the attribute [contractType]= <b>SBTS</b> , then object tariffPlan=Vidutinė įtampa cannot be specified, if current tariffPlan of object is not "Vidutinė įtampa".	+	+	+	49	If the contract type "SBTS" and the current tariff plan of object [objectNumber] is not "Vidutinė įtampa", then the new tariff plan can be "Namai" / "Namai plius" / "Standartinis" / "Išmanusis".	tariffPlan, contractType

68.	If the attribute <b>[changeType]=SK/STK</b> , <b>[contractType]=SKMS</b> , then attribute <b>[timeZone]</b> is required.	+	+	-	123	If the contract type is "SKMS" it is mandatory to indicate "Time zone".	contractType, changeType, timeZone
69.	If the object <b>contractType=SKMS</b> and <b>PermittablePowerConsumption &lt;=30 kw</b> , the attribute's <b>[timeZone]</b> possible values: <ul style="list-style-type: none"> <li>• 1 or;</li> <li>• 2.</li> </ul>	+	+	+	124	If the contract type is "SKMS" of the object: <b>[objectNumber]</b> and <b>PermittablePowerConsumption &lt;= 30 kw</b> , then the time zone must be "One" or "Two".	contractType, changeType, timeZone, power
70.	If the object <b>contractType=SKMS</b> and <b>PermittablePowerConsumption &gt; 30 kw</b> , the attribute's <b>[newTimeZone]</b> possible values: <ul style="list-style-type: none"> <li>• VR or;</li> <li>• DR.</li> </ul>	+	+	+	125	If the contract type is "SKMS" of the object: <b>[objectNumber]</b> and <b>permittable power consumption &gt; 30 kw</b> , then the time zone must be "One with reactive" or "Differentiated with reactive ones".	contractType, changeType, timeZone, power
71.	If the attribute <b>[changeType] = SK / STK</b> , <b>[contractType] = SKMS</b> and the object failed to determine the valid usable power, the change is not possible.  If the attribute <b>[changeType] = NTK</b> , <b>[contractType] = SKMS</b> and the attribute <b>[timeZone]</b> is specified, then if the object failed to determine the	+	+	+	127	Failed to set usable power for the object <b>[objectNumber]</b> .	changeType, contractType, timeZone

	valid usable power, then the change is not possible.							
72.	If the <b>contractType=SKMS</b> , then the attribute <b>[tariffPlan]</b> cannot be specified.	+	+	+	126	If the contract type is "SKMS", then the tariff plan cannot be specified.	contractType, changeType, tariffPlan	
73.	If the <b>changeType=SK/STK</b> , then the attribute <b>[ntGetCoownerConsent]</b> is required.  The meaning of the <b>[ntGetCoownerConsent]</b> attribute must be: <ul style="list-style-type: none"> <li>• True or</li> <li>• False.</li> </ul>	+	+	-	140	The attribute "NT get coowner consent" is required.	ntGetCoownerConsent	
74.	<del>The provided effective date of the object contract cannot be equal to the effective date of the existing object contract.</del>	+	+		51	<del>For objects [objectNumber (if there is more than one object, objects must be separated by the semicolon)] the provided effective date is equal to the effective date of the existing object contract.</del>	contractStart, contract_object.valid_from, independent_supplier_object.valid_from	
75.	Attribute <b>[changeType]</b> is required.  Values of attribute <b>[changeType]</b> : <ul style="list-style-type: none"> <li>• SK</li> <li>• STK</li> <li>• NTK</li> </ul>	+	+	+	-	-	changeType	

	76.	If the attribute <b>[changeType] = NTK</b> and <b>[contractType] = SBTS</b> and the object is a <b>generating user = G (GV)</b> and the attribute <b>[payoffMethod]</b> (not null) is specified, the payoff method can be changed if the date of the change in the GV payoff method is earlier or equal to the date of "Contract start".	-	-	+	134	Change not possible. Object: <b>[objectNumber]</b> possible generating capacity user payoff method change <b>[date]</b> date is later than the date of contract start.	changeType, contractType, payoffMethod
--	-----	--	---	---	---	-----	--	--

### 7.8.2.1 JSON Request structure

The table below describes the structure of the JSON request:

No.	Attribute	type	obligation	description
1.	changeType	String(10)	required	Change type. Possible meanings: <ul style="list-style-type: none"> <li>• SK - Owner change;</li> <li>• STK - Owner and supplier change.</li> </ul>
2.	contractType	String(10)	required	Contract type. Possible meanings: <ul style="list-style-type: none"> <li>• SBTS - Household customer;</li> <li>• SKMS - Commercial customer.</li> </ul>
3.	contractStart	Date	required	Start date of entry into force of the contract at an independent supplier.
4.	consentSign	Boolean	required	Indication of whether the data provided by the contract owner / owner and supplier are correct. Possible meanings: <ul style="list-style-type: none"> <li>- True;</li> <li>- False.</li> </ul>
5.	supplierContractNo	String(30)	not required	Contract number.
6.	notes	String(4000)	not required	Notes.

No.	Attribute	type	obligation	description
correspondenceAddress				
7.	street	String(200)	not required	Street.
8.	building	String(100)	not required	Building.
9.	housingNo	String(100)	not required	Housing.
10.	apartment	String(20)	not required	Flat.
11.	locality	String(200)	not required	Town / Village.
12.	eldership	String(200)	not required	Eldership.
13.	municipality	String(200)	not required	Municipality.
14.	county	String(200)	not required	County.
ownerInfo				
15.	subjectType	String(10)	required	Contract owner / tenant person type. Possible meaning:  FAS - individual; JAS - Juridical.
16.	personName	String(200)	required	Contract owner / tenant / company name.
17.	personSurname	String(50)	not required	Contract owner / tenant surname.
18.	personCode	String(20)	not required	Contract owner / tenant person / company code
19.	birthDate	Date	not required	Contract owner / tenant birth date.
20.	vatCode	String(15)	not required	Contract owner / tenant VAT code.
ownerInfo.contacts				
21.	mobPhoneNoNetwork	String(12)	not required	Mobile phone number for networks.

No.	Attribute	type	obligation	description
				Contact details for information on network work (accounting maintenance, electrical disconnections and faults).
22.	mobPhoneNo2Network	String(12)	not required	Mobile phone number 2 for networks. Contact details for information on network work (accounting maintenance, electrical disconnections and faults).
23.	mobPhoneNoInvoice	String(12)	not required	Mobile phone number for bills. Contact details for informing about formed invoices and provided services.
24.	telPhoneNoNetwork	String(12)	not required	Phone number for networks. Contact details for information on network work (accounting maintenance, electrical disconnections and faults).
25.	emailNetwork	String(49)	not required	An email address for networks. Contact details for information on network work (accounting maintenance, electrical disconnections and faults).
26.	email2Network	String(49)	not required	An email address 2 for networks. Contact details for information on network work (accounting maintenance, electrical disconnections and faults).
27.	emailInvoice	String(100)	not required	An email address 2 for networks. Contact details for information on network work (accounting maintenance, electrical disconnections and faults).
objects[]				
28.	objectNumber	String(20)	required	Object number.
29.	tariffPlan	String(200)	not required	Chosen tariff plan of the SBTS contract
30.	contractModel	String(10)	required	Contract model of the current object. Possible meanings:



No.	Attribute	type	obligation	description
				BSS - General contract bills; 2S2S - Two contracts – Two bills.
31.	timeZone	String(2)	not required	Current time zone of the object. Possible meanings:  1 - One; 2 - Two; VR - One with reactive; 4 - Four (Smart); DR - Differentiated with reactive.
32.	payoffMethod	String(1)	not required	Chosen pay of method of the generating consumer. Possible meanings:  <ul style="list-style-type: none"> <li>• E – kWh – Recovered electricity;</li> <li>• G - kW – Power plant installed power;</li> <li>• <del>M - kWh or kW – Mixed;</del></li> <li>• P - % - Payment percentage.</li> </ul>
33.	objectNtr	String(20)	not required	Real estate cadaster and register number of the object of the State Enterprise Registers Center.
34.	objectNtrDate	Date	not required	Date of the Real estate cadaster and register number of the object of the State Enterprise Register Center.
35.	uniqueRoomNo	String(20)	not required	Unique room number.
36.	ntGetCoownerConsent	Boolean	required	The feature or independent supplier has received the consent of the co-owners. Possible meanings:  <ul style="list-style-type: none"> <li>• True;</li> <li>• False</li> </ul>
37.	auctionDate	Date	not required	Date of acquisition of the object from the auction.

### 7.8.2.2 JSON Response structure

The following table describes the JSON structure in the event of a response:

No.	Attribute	type	obligation	description
1.	notificationId	Integer	required	Notification ID.

### 7.8.2.3 Error Response structure

The following table describes the JSON structure in the event of a response error:

No.	Attribute	type	obligation	description
1.	code	number	required	Error code.
2.	text	string(4000)	required	Error message.

### 7.8.3 POST /gateway/notification/{notificationId}/contract/cancel

<b>URI</b>	POST /gateway/notification/{notificationId}/contract/cancel		
<b>Description</b>	The method is to cancel the change of contract owner / contract owner and supplier / <a href="#">supplier</a> notification.		
<b>Parameters</b>	<b>URL:</b> <i>notificationId</i> - message identifier. Mandatory.		
<b>Header</b>	After encrypting the supplier authentication key, the supplier ID is used to verify that the supplier is revoking its message.		
<b>Request</b>	POST request does not have the BODY part.		
<b>Response HTTP code</b>	<b>HTTP status code</b>	<b>Reason</b>	<b>Description</b>
	201	Created	Request completed successfully.

	400	Bad Request	Request error. The HTTP response body provides a list of errors in JSON format. ( <i>Error response of the JSON structure below</i> ).		
	401	Unauthorized	An attempt was made to connect to a non-public method that requires authentication, but no user credentials were provided.		
	403	Forbidden	According to the access control policy, the current user does not have access to perform the requested action.		
	404	Not Found	Either there is no API method associated with the request URL path, or the request contains one or more parameters that did not return the data.		
<b>Response</b>					
<b>JSON error response</b>	<pre>{   "errorMessages": [     {       "code": 0,       "text": "string"     }   ] }</pre>				
<b>Rules</b>	<b>No.</b>	<b>Rule description</b>	<b>Error code</b>	<b>Error message</b>	<b>Attributes</b>
	0.	If an attribute has defined possible values, the value index can be specified by specifying the value of the attribute in the request. Indices of all possible values start from 0.	-	-	All attributes with specified values.
	1.	The request can be canceled:	50	According to the given parameters, the	contract_change_status.status, contract_change_status.status.date

		only one time; when the notification state is "Pateiktas"; when the cancellation deadline has not passed (Initial value - 1 hour).		message to be canceled could not be found / the cancellation deadline has expired / the message has already been canceled.	
	2.	Upon successful cancellation of the owner / owner and supplier change request, the status of the request becomes "Atšauktas".	-	-	contract_change_status.status, contract_change_status.status.date

### 7.8.3.1 Error Response structure

The following table describes the JSON structure in the event of a response error:

No.	Attribute	type	obligation	description
1.	code	number	required	Error code.
2.	text	string(4000)	required	Error message.

## 7.9 Notification contract termination controller

### 7.9.1 POST /gateway/notification/contract/termination/list?first={integer}&count={integer}&sortOrder={ASC/DSC}

<b>URI</b>	POST /gateway/notification/contract/termination/list?first={integer}&count={integer}&sortOrder={ASC/DSC}		
<b>Description</b>	Method to obtain information of the contract termination.		
<b>Parameters</b>	<p><b>URL:</b></p> <p><b>first</b> - the index of the notification, which must be the first in the return list (starting from 0). Optional. The default value is 0.  <b>count</b> - the number of notification rows in the return list. Optional. The default value is 30.  <b>sort</b> - possible values ASC, DSC.</p> <p>The data of the JSON form request are presented in the HTTP request body (<b>BODY</b>) (Query JSON structure, below).</p>		
<b>Header</b>	After decrypting the supplier authentication key, the supplier ID is used to select the data.		
<b>JSON request</b>	<pre>{   "personCode": "string",   "objectNumber": "string",   "notificationId": "number",   "contractTerminationDateFrom": "datetime",   "contractTerminationDateTo": "datetime",   "submittedDateFrom": "datetime",   "submittedDateTo": "datetime",   "status": "string",   "contractTerminationReason": "string",   "userNameSearch": "string" }</pre>		
<b>Response HTTP code</b>	<b>HTTP status code</b>	<b>Reason</b>	<b>Description</b>
	200	OK	Request completed successfully
	204	No Content	No data found according to the given parameters.
	400	Bad Request	Request error. The HTTP response body provides a list of errors in JSON format. ( <i>Error response of the JSON structure below</i> ).

	401	Unauthorized	An attempt was made to connect to a non-public method that requires authentication, but no user credentials were provided.
	403	Forbidden	According to the access control policy, the current user does not have access to perform the requested action.
	404	Not Found	Either there is no API method associated with the request URL path, or the request contains one or more parameters that did not return the data.

**JSON response**

```
[
  {
    "notificationId":"number",
    "contractTerminationDate":"date",
    "contractTerminationReason":"string",
    "userName":"string",
    "submittedDate":"datetime",
    "latestStatus":"string",
    "errorType":"string",
    "objects":[
      {
        "personName":"string",
        "personSurname":"string",
        "personCode":"string",
        "consumerCode":"string",
        "objectNumber":"string",
        "objectAddress":"string",
        "contractType":"string",
        "contractModel":"string",
        "contractStart":"date",
        "coowner":"boolean",
        "coownerConsentDate":"date"
      }
    ],
    "contractTerminationNotificationStatus":[
      {
```

	<pre>                 "status": "string",                 "statusDate": "datetime"             }         ]     } ] </pre>				
<b>JSON error response</b>	<pre> {   "errorMessages": [     {       "code": 0,       "text": "string"     }   ] } </pre>				
<b>Rules</b>	<b>No.</b>	<b>Rule description</b>	<b>Error code</b>	<b>Error message</b>	<b>Attributes</b>
	0.	If an attribute has defined possible values, the value index can be specified by specifying the value of the attribute in the request. Indices of all possible values start from 0.	-	-	All attributes with specified values.
	1.	No data found according to the given parameters.	HTTP 204	-	-
	2.	One or more request parameters are required.	1001	One or more request parameters are required.	-
	3.	DateFrom cannot be later than DateTo. Equal can be.	1002	DateFrom cannot be later than DateTo.	dateFrom

### 7.9.1.1 JSON Request structure

The table below describes the structure of the JSON response:

No.	Attribute	type	obligation	description
1.	personCode	String(20)	not required	Person / company code.
2.	objectNumber	String(20)	not required	Object number.
3.	notificationId	Integer	not required	Notification ID.
4.	contractTerminationDateFrom	DateTime	not required	Contract termination date from.
5.	contractTerminationDateTo	DateTime	not required	Contract termination date to.
6.	submittedDateFrom	DateTime	not required	Submitted date from.
7.	submittedDateTo	DateTime	not required	Submitted date to.
8.	status	String(10)	not required	Notification status. Possible meanings: <ul style="list-style-type: none"> <li>• P - Submitted</li> <li>• A – Cancelled</li> <li>• I – Sent</li> <li>• V - In progress</li> <li>• IV – Completed</li> <li>• K - Error.</li> </ul>
9.	contractTerminationReason	String(1)	not required	Contract termination reason. Possible meanings: <ul style="list-style-type: none"> <li>• N - The termination of the contract between customer and the supplier;</li> <li>• P - The termination of the contract between customer and the supplier in cases of sale or termination / end of the lease;</li> <li>• L – Closure of the object in case of liquidation.</li> </ul>



No.	Attribute	type	obligation	description
				<ul style="list-style-type: none"> <li>M – Termination due to death</li> </ul>
10.	userNameSearch	String(240)	not required	The user who created a notification.

### 7.9.1.2 JSON Response structure

The table below describes the structure of the JSON response:

No.	Attribute	type	obligation	description
contractTerminationNotification				
1.	notificationId	Integer	required	Notification ID
2.	contractTerminationDate	Date	required	Date of the contract termination
3.	contractTerminationReason	String(1)	required	Contract termination reason. Possible meanings: <ul style="list-style-type: none"> <li>N - The termination of the contract between customer and the supplier;</li> <li>P - The termination of the contract between customer and the supplier in cases of sale or termination / end of the lease;</li> <li>L – Closure of the object in case of liquidation.</li> <li>M – Termination due to death</li> </ul>
4.	userName	String(240)	not required	The user who created the post.
5.	submittedDate	DateTime	required	Submitted date of notification.

No.	Attribute	type	obligation	description
6.	latestStatus	String(10)	required	Notification latest status. Possible meanings: <ul style="list-style-type: none"> <li>• P - Submitted</li> <li>• A – Cancelled</li> <li>• I - Sent</li> <li>• V - In progress</li> <li>• IV – Completed</li> <li>• K - Error.</li> </ul>
7.	errorType	String(10)	not required	Notification error type if status=K (Error). Possible meanings: <ul style="list-style-type: none"> <li>▪ KT - Other works performed, the contract is not terminated, the object is not liquidated</li> <li>▪ NL - Failed to access object, object not liquidated</li> <li>▪ NP - The contract has already been terminated</li> <li>▪ KL - Incorrect message</li> <li>▪ NN - Termination is not possible because the data of the old contract does not match</li> <li>▪ NS - Termination is not possible, the contract will be terminated with a change of the owner / owner and supplier notification</li> <li>▪ ND – It is not possible to carry out liquidation work</li> <li>▪ NA - Termination not possible, owner has not been changed</li> </ul>
objects[]				
8.	personName	String(200)	required	Contract owner / tenant name.
9.	personSurname	String(50)	not required	Contract owner / tenant name surname.

No.	Attribute	type	obligation	description
10.	personCode	String(20)	not required	Contract owner / tenant person / company code.
11.	consumerCode	String(20)	required	Contract owner / tenant consumer code.
12.	objectNumber	String(20)	required	Object number.
13.	objectAddress	String(4000)	required	Object address.
14.	contractType	String(10)	required	Contract type. Possible meanings: <ul style="list-style-type: none"> <li>• SBTS - Household contract;</li> <li>• SKMS - Commercial contract.</li> </ul>
15.	contractModel	String(10)	required	Contract model of the current object. Possible meanings: <ul style="list-style-type: none"> <li>• BSS - General contract bills;</li> <li>• 2S2S - Two contracts – Two bills.</li> </ul>
16.	contractStart	Date	required	Date of entry into force of the notification subject to the independent supplier from.
17.	coowner	Boolean	not required	Indication that there is co-owner.
18.	coownerConsentDate	Date	not required	Date of co-owner's consent.
<b>contractTerminationNotificationStatus</b>				
19.	status	String(10)	required	Notification status. Possible meanings:

No.	Attribute	type	obligation	description
				<ul style="list-style-type: none"> <li>• P - Submitted</li> <li>• A – Cancelled</li> <li>• I - Sent</li> <li>• V - In progress</li> <li>• IV - Completed</li> <li>• K - Error.</li> </ul>
20.	statusDate	DateTime	required	Status date.

### 7.9.1.3 Error Response structure

The following table describes the JSON structure in the event of a response error:

No.	Attribute	type	obligation	description
1.	code	number	required	Error code.
2.	text	string(4000)	required	Error message.

### 7.9.2 POST /gateway/notification/contract/termination

<b>URI</b>	POST /gateway/notification/contract/termination
<b>Description</b>	The method is for NT to transfer contract termination to DataHub.
<b>Parameters</b>	<p><b>URL:</b></p> <p>The data of the JSON form request are presented in the HTTP request body (<b>BODY</b>) (Query JSON structure, below).</p>

<b>Header</b>	After decrypting the supplier authentication key, the supplier ID is used to select the data.		
<b>JSON request</b>	<pre>{   "contractTerminationDate":"date",   "contractTerminationReason":"string",   "consentSign":"boolean",   "objects":[     {       "objectNumber":"string",       "coowner":"boolean",       "coownerConsentDate":"date"     }   ] }</pre>		
<b>Response HTTP code</b>	<b>HTTP status code</b>	<b>Reason</b>	<b>Description</b>
	201	Created	Request completed successfully
	400	Bad Request	Request error. The HTTP response body provides a list of errors in JSON format. ( <i>Error response of the JSON structure below</i> ).
	401	Unauthorized	An attempt was made to connect to a non-public method that requires authentication, but no user credentials were provided.
	403	Forbidden	According to the access control policy, the current user does not have access to perform the requested action.
	404	Not Found	Either there is no API method associated with the request URL path, or the request contains one or more parameters that did not return the data.

<b>JSON response</b>	<pre>{   "notificationId": "number" }</pre>				
<b>JSON error response</b>	<pre>{   "errorMessages": [     {       "code": 0,       "text": "string"     }   ] }</pre>				
<b>Rules</b>	<b>No.</b>	<b>Rule description</b>	<b>Error code</b>	<b>Error message</b>	<b>Attributes</b>
	0.	If an attribute has defined possible values, the value index can be specified by specifying the value of the attribute in the request. Indices of all possible values start from 0.	-	-	All attributes with specified values.
	1.	Submitted object cannot have the same / matching meters numbers.	76	Contract termination not possible. Objects: <b>[objectNumber (if there is more than one object, objects must be separated by the semicolon)]</b> have the same / matching meter number.	object_meter.meter_number, object_meter.valid_from, object_meter.valid_to, object.object_number, object.object_id, objectNumber
	2.	The attribute <b>[ObjectNumber]</b> is mandatory.	-	-	objectNumber

	3.	The meaning of the <b>[ObjectNumber]</b> notification cannot be repeated.	7	The object: [objectNumber (if there is more than one object, objects must be separated by the semicolon)] is repeating..	objectNumber
	4.	Must be specified valid object.	8	The object: [objectNumber (if there is more than one object, objects must be separated by the semicolon)] not found in the system.	objectNumber
	5.	The object must belong to a valid supplier contract that provides the notification.	9	The object: [objectNumber (if there is more than one object, objects must be separated by the semicolon)] does not belong to a valid supplier contract.	objectNumber, independentSupplierId, independent_supplier_obj ects.valid_from, independent_supplier_obj ects.valid_to, contract.con clusion_date
	6.	The attribute <b>[contractTerminationDate]</b> format must be: yyyy-mm-dd. yyyy - year; mm - month; dd - day.	-	-	contractTerminationDate
	7.	The attribute <b>[contractTerminationReason]</b> must be: <ul style="list-style-type: none"> <li>▪ N or</li> <li>▪ P or</li> <li>▪ L or</li> <li>▪ M</li> </ul>	-	-	contractTerminationReason

	8.	Attributes [ <b>contractTerminationDate</b> ] and [ <b>contractTerminationReason</b> ] are mandatory.	-	-	contractTerminationDate, contractTerminationReason
	9.	<p>If the attribute [<b>contractTerminationReason</b>] =N, then the attribute [<b>contractTerminationDate</b>] must be:</p> <ul style="list-style-type: none"> <li>▪ the last date of the current month, if the request was made until the config month day (initial value =18);</li> <li>▪ the last date of the next month, if the request was made after the config month day (initial value =18).</li> </ul>	70	Date of the contract termination [ <b>contractTerminationDate</b> ] must be equal to the last date of a current month, if the request was made until a current month [ <b>config day</b> ] day, or must be equal to the last date of a next month, if the request was made after a current month [ <b>config date</b> ] day.	contractTerminationDate
	10.	<p>If the attribute [<b>contractTerminationreason</b>]=P, then the attribute [<b>contractTerminationDate</b>] can be equal to the current date or later.</p> <p>Ex.: If the current date is 2021-02-08 , then [<b>contractTerminationDate</b>] start date can be any date from 2021-02-08 to X day to the future.</p>	71	Date of the contract termination [ <b>contractTerminationDate</b> ] can be equal to the current date or later.	contractTerminationDate



	11.	If the attribute [ <b>contractTerminationreason</b> ]=L or attribute [ <b>contractTerminationreason</b> ]=M, then the attribute [contractTerminationDate] must be equal to the current date .	72	Date of the contract termination [ <b>contractTerminationDate</b> ] must be equal to the current date.	contractTerminationDate
	12.	Date of the contract termination cannot be equal to date of contract start.	73	Date of the contract termination [ <b>contractTerminationDate</b> ] cannot be equal to objects [ <b>objectNumber (if there is more than one object, objects must be separated by the semicolon)</b> ] contract start date.	objectNumber, contract_object.valid_from, independent_supplier_object.valid_from, contractTerminationDate
	13.	The contract cannot be terminated for the object if the termination has already been submitted / in progress/ completed / sent.	74	The contract cannot be terminated for the object [ <b>objectNumber (if there is more than one object, objects must be separated by the semicolon)</b> ] because the termination of the contract has already been submitted.	objectNumber, contract_termination_notification.object_number,  contract_termination_notification_object.contract_object_id,  contract_termination_notification_status
	14.	The meaning of the [ <b>consentSign</b> ] must be: <ul style="list-style-type: none"> <li>▪ True or</li> <li>▪ False.</li> </ul>	-	-	consentSign

	15.	If the attribute <b>[consentSign] = False</b> , then the contract termination must be disabled.	32	It is necessary to confirm that the data provided is correct.	consentSign
	16.	Upon successful creation of a contract termination request, the status of the request becomes "Submitted".	-	-	contract_termination_notification_status.status, contract_termination_notification_status.status_date
	17.	The supplier will be identified by the authentication key.	1003	The independent supplier cannot be found in the system or supplier is not active.	independent_supplier.id, contract_termination_notification.independent_supplier_id
	18.	All objects of the notification must belong to the same contract.	43	Change not possible. Different contracts for submitted objects.	objectNumber, consumerCode
	19.	Date of the contract termination cannot be later than the date of contract end.	120	Date of the contract termination [contractTerminationDate] cannot be later than objects <b>[objectNumber (if there is more than one object, objects must be separated by the semicolon)]</b> the date of contract end.	objectNumber, contract_object.valid_to, independent_supplier_object.valid_to, contractTerminationDate
	20.	If [contractTerminationReason] =L, then one of the fields is required: <ul style="list-style-type: none"> <li>coowner or</li> </ul>	121	If contract termination reason is "Closure of the object in case of liquidation", then one of the attributes is required "No co-owner" or "Co-owner consent date".	contractTerminationReason, coowner, coownerConsentDate

		<ul style="list-style-type: none"> <li>coownerConsentDate</li> </ul> <p>An error occurs when neither is not specified.</p>			
	21.	<p>If [contractTerminationReason] is not equal L, then the fields must not be specified:</p> <ul style="list-style-type: none"> <li>coowner</li> <li>coownerConsentDate</li> </ul>	122	<p>If contract termination reason is not "Closure of the object in case of liquidation", then attributes "No co-owner", "Co-owner consent date" must not be specified.</p>	contractTerminationReason, coowner, coownerConsentDate
	22.	<p>Values of attribute [coowner] must be:</p> <ul style="list-style-type: none"> <li>True</li> <li>False</li> </ul>	-	-	coowner
	23.	<p>The format of attribute [coownerConsentDate] must be yyyy-mm-dd.</p>	-	-	coownerConsentDate
	24.	<p>If the field [ntGetCoownerConsent] is specified, the field [coownerConsentDate] must be specified.</p>	124	<p>If the attribute "NT-get co-owner consent" is specified, then must be specified "Co-owner consent date".</p>	ntGetCoownerConsent, coownerConsentDate
	25.	<p>If the field [ntGetCoownerConsent] is not specified, the field</p>	125	<p>If the attribute "NT-get co-owner consent" is not specified,</p>	ntGetCoownerConsent, coownerConsentDate

		<del>[coownerConsentDate] must be not specified.</del>		<del>then must be not specified "Co-owner consent date".</del>	
	26.	If [contractTerminationReason]=L or P or M, then it can be filed only one object for one termination of contract request.	127	If contract termination reason is "Closure of the object in case of liquidation" or "The termination of the contract between customer and the supplier in cases of sale or termination / end of the lease" or "Termination due to death", then it can be filed only one object for one termination of contract request.	contractTerminationReason, objectNumber
	27.	If the field [coowner]=TRUE, the field [coownerConsentDate] must be specified.  If the field [coowner]=FALSE, the field [coownerConsentDate] must be not specified.	128	If there is a co-owner, the date of the co-owner's consent must be indicated. If there is not a co-owner, the date of consent is not indicated.	coowner, coownerConsentDate

### 7.9.2.1 JSON Request structure

The table below describes the structure of the JSON request:

No.	Attribute	type	obligation	description
1.	contractTerminationDate	Date	required	Date of contract termination.

No.	Attribute	type	obligation	description
2.	contractTerminationReason	String(1)	required	Contract termination reason. Possible meanings: <ul style="list-style-type: none"> <li>• N - The termination of the contract between customer and the supplier;</li> <li>• P - The termination of the contract between customer and the supplier in cases of sale or termination / end of the lease;</li> <li>• L – Closure of the object in case of liquidation</li> <li>• M - Termination due to death.</li> </ul>
3.	consentSign	Boolean	required	Indication of whether the data provided by the contract owner / owner and supplier are correct. Possible meanings: <ul style="list-style-type: none"> <li>• True;</li> <li>• False.</li> </ul>
	objects:[]			
4.	objectNumber	String	required	Object number.
5.	coowner	Boolean	not required	Indication that there is co-owner.
6.	<del>ntGetCoownerConsent</del>	<del>Boolean</del>	<del>not required</del>	<del>Indication of whether the independent supplier has obtained the consent of the co-owner.</del>
7.	coownerConsentDate	Date	not required	Date of co-owner's consent.

### 7.9.2.2 JSON Response structure

The following table describes the JSON structure in the event of a response:

No.	Attribute	type	obligation	description
1.	notificationId	Integer	required	Notification ID.

### 7.9.2.3 Error Response structure

The following table describes the JSON structure in the event of a response error:

No.	Attribute	type	obligation	description
1.	code	number	required	Error code.
2.	text	string(4000)	required	Error message.

### 7.9.3 POST /gateway/notification/{notificationId}/contract/termination/cancel

<b>URI</b>	POST /gateway/notification/{notificationId}/contract/termination/cancel		
<b>Description</b>	The method is to cancel the contract termination notification.		
<b>Parameters</b>	<b>URL:</b> <ul style="list-style-type: none"> <li>• <b>notificationId</b> – message identifier. Mandatory.</li> </ul>		
<b>Header</b>	After encrypting the supplier authentication key, the supplier ID is used to verify that the supplier is revoking its message.		
<b>Request</b>	POST request does not have the BODY part.		
<b>Response HTTP code</b>	<b>HTTP status code</b>	<b>Reason</b>	<b>Description</b>

	201	Created	Request completed successfully.		
	400	Bad Request	Request error. The HTTP response body provides a list of errors in JSON format. ( <i>Error response of the JSON structure below</i> ).		
	401	Unauthorized	An attempt was made to connect to a non-public method that requires authentication, but no user credentials were provided.		
	403	Forbidden	According to the access control policy, the current user does not have access to perform the requested action.		
	404	Not Found	Either there is no API method associated with the request URL path, or the request contains one or more parameters that did not return the data.		
<b>Response</b>					
<b>JSON error response</b>		<pre> {   "errorMessages":   [     {       "code": 0,       "text": "string"     }   ] } </pre>			
<b>Rules</b>					
	<b>No.</b>	<b>Rule description</b>	<b>Error code</b>	<b>Error message</b>	<b>Attributes</b>
	0.	If an attribute has defined possible values, the value index can be specified by specifying the value of the attribute in the request. Indices of all possible values start from 0.	-	-	All attributes with specified values.

	1.	<p>The request can be canceled:</p> <ul style="list-style-type: none"> <li>• only one time;</li> <li>• when the notification state is "Pateiktas";</li> <li>• when the cancellation deadline has not passed (Initial value - 1 hour).</li> </ul>	50	<p>According to the given parameters, the message to be canceled could not be found / the cancellation deadline has expired / the message has already been canceled.</p>	<p>contract_termination_notification_status.status, contract_termination_notification_status.date</p>
	2.	<p>Upon successful cancellation of the contract termination request, the status of the request becomes "Atšauktas".</p>	-	-	<p>contract_termination_notification_status.status, contract_termination_notification_status.date</p>

### 7.9.3.1 Error Response structure

The following table describes the JSON structure in the event of a response error:

No.	Attribute	type	obligation	description
1.	code	number	required	Error code.
2.	text	string(4000)	required	Error message.

## 7.10 Notification contract tariff plan controller *(will be deployed in the future)*

### 7.10.1 POST /gateway/notification/contract/tariff-plan/list?first={integer}&count={integer}&sortKey={string}&sortOrder={ASC/DSC}



<b>URL</b>	POST /gateway/notification/contract/tariff-plan/list??first={integer}&count={integer}&sortKey={string}&sortOrder={ASC/DSC}		
<b>Description</b>	The method is designed to obtain an information of tariff change		
<b>Parameters</b>	<p><b>URL:</b></p> <ul style="list-style-type: none"> <li>• <b>first</b> - index (starting from 0) of the notification that must be presented first in the return list. Optional. The default value is 0.</li> <li>• <b>count</b> - number of objects in the return list. Optional. The default value is 30.</li> <li>• <b>sort</b> - possible values ASC, DSC.</li> </ul> <p>The data of the JSON form request are presented in the HTTP request body (<b>BODY</b>) (Query JSON structure, below).</p>		
<b>Header</b>	After decrypting the supplier authentication key, the supplier ID is used to select the data.		
<b>Request</b>	<pre>{   "notificationId":"number",   "personCode":"string",   "consumerCode":"string",   "objectNumber":"string",   "objectAddressSearch":"string",   "status":"string",   "submittedDateFrom":"datetime",   "submittedDateTo":"datetime",   "newTariffPlanSearch":"string",   "newTimeZone":"string",   "contractType":"string",   "contractModel":"string",   "userNameSearch":"string" }</pre>		
<b>Response HTTP codes</b>	<b>HTTP status code</b>	<b>Reason</b>	<b>Description</b>
	200	OK	Request completed successfully.

	204	No Content	No data found according to the given parameters.
	400	Bad Request	Request error. The HTTP response body provides a list of errors in JSON format. ( <i>Error response of the JSON structure below</i> ).
	401	Unauthorized	An attempt was made to connect to a non-public method that requires authentication, but no user credentials were provided.
	403	Forbidden	According to the access control policy, the current user does not have access to perform the requested action.
	404	Not Found	Either there is no API method associated with the request URL path, or the request contains one or more parameters that did not return the data.

**Response**

```
[
  {
    "notificationId":"number",
    "latestStatus":"string",
    "errorType":"string",
    "submittedDate":"datetime",
    "userName":"string",
    "objects":[
      {
        "personName":"string",
        "personSurname":"string",
        "personCode":"string",
        "consumerCode":"string",
        "objectNumber":"string",
        "objectAddress":"string",
        "contractType":"string",
        "contractModel":"string",
        "tariffPlan":"string",
        "timeZone":"string",
        "newTariffPlan":"string",
        "newTimeZone":"string"
      }
    ],
    "status":[
      {
        "status":"string",
```

	<pre>       "statusCode": "datetime"     }   ] } ] </pre>				
<b>JSON error response</b>	<pre> {   "errorMessagees": [     {       "code": 0,       "text": "string"     }   ] } </pre>				
<b>Rules</b>	<b>No.</b>	<b>Rule description</b>	<b>Error code</b>	<b>Error message</b>	<b>Attributes</b>
	0.	If an attribute has defined possible values, the value index can be specified by specifying the value of the attribute in the request. Indices of all possible values start from 0.	-	-	-
	1.	No data found according to the given parameters.	HTTP 204	-	-
	2.	DateFrom cannot be later than DateTo. Equal can be.	1002	DateFrom cannot be later than DateTo.	submittedDateFrom, submittedDateTo

### 7.10.1.1 JSON Request structure

The table below describes the structure of the JSON request:

No.	Attribute	type	obligation	Description
1.	notificationId	Integer	not required	Tariff plan change notification ID
2.	personCode	String(20)	not required	Contract owner / tenant person / company code.
3.	consumerCode	String(20)	not required	Contract owner / tenant consumer code.
4.	objectNumber	String(20)	not required	Object number.
5.	objectAddressSearch	String(4000)	not required	Object address. The search by the fragment.
6.	status	String(20)	not required	Notification newest status. Possible meanings: <ul style="list-style-type: none"> <li>• P - Submitted</li> <li>• A - Cancelled</li> <li>• I - Sent</li> <li>• V – In progress</li> <li>• IV - Completed</li> <li>• K - Error</li> </ul>
7.	submittedDateFrom	DateTime	not required	<ul style="list-style-type: none"> <li>• The submission date from of the notification.</li> <li>• Format: yyyy-mm-dd</li> </ul>
8.	submittedDateTo	DateTime	not required	<ul style="list-style-type: none"> <li>• The summation date to of the notification.</li> <li>• Format: yyyy-mm-dd</li> </ul>
9.	contractType	String(20)	not required	Contract type of the current object. Possible meanings: <ul style="list-style-type: none"> <li>• SBTS - Household customer;</li> <li>• SKMS - Commercial customer.</li> </ul>
10.	contractModel	String(10)	not required	Contract model of the current object. Possible meanings: <ul style="list-style-type: none"> <li>• BSS - General contract bills;</li> <li>• 2S2S - Two contracts – Two bills.</li> </ul>
11.	newTariffPlanSearch	String(200)	not required	<ul style="list-style-type: none"> <li>• Object's full name of the tariff plan;</li> <li>• Search by the fragment.</li> </ul>
12.	newTimeZone	String(4)	not required	Current time zone of the object. Possible meanings:

No.	Attribute	type	obligation	Description
				<ul style="list-style-type: none"> <li>• 1 - One;</li> <li>• 2 - Two;</li> <li>• VR - One with reactive;</li> <li>• 4 - Four (Smart);</li> <li>• DR - Differentiated with reactive;</li> <li>• N - Not established.</li> </ul>
13.	userNameSearch	String(240)	not required	The user who created a notification. Search by the fragment.

### 7.10.1.2 JSON Response structure

The table below describes the structure of the JSON response:

No.	Attribute	type	obligation	description
1.	notificationId	Integer	required	Tariff plan change notification ID.
2.	latestStatus	String(20)	required	Notification newest status. Possible meanings: <ul style="list-style-type: none"> <li>• P - Submitted</li> <li>• A - Cancelled</li> <li>• I - Sent</li> <li>• V – In progress</li> <li>• IV - Completed</li> <li>• K - Error</li> </ul>
3.	errorType	String(10)	not required	Notification error type if status=K (Error).
4.	submittedDate	DateTime	required	The submission date of the notification
5.	userName	String(240)	not required	The user who initiates the tariff plan change notification
6.	name	String(200)	required	Contract owner / tenant / company name.

No.	Attribute	type	obligation	description
7.	surname	String(50)	not required	Contract owner / tenant surname.
8.	personCode	String(20)	not required	Person / tenant / company code.  If the subject is an individual than person code must be returned encrypted: [*****][the last 3 symbols of the person code]
9.	consumerCode	String(20)	required	Contract owner / tenant consumer code.
10.	objectNumber	String(20)	required	Object number.
11.	objectAddress	String(4000)	required	Object address.
12.	contractType	String(10)	required	Contract type of the current object. Possible meanings: <ul style="list-style-type: none"> <li>• SBTS - Household customer;</li> <li>• SKMS - Commercial customer.</li> </ul>
13.	contractModel	String(10)	required	Contract model of the current object. Possible meanings: <ul style="list-style-type: none"> <li>• BSS - General contract bills;</li> <li>• 2S2S - Two contracts – Two bills.</li> </ul>
14.	tariffPlan	String(200)	required	The object tariff plan. The tariff plan was saved as current during the notification submission.
15.	timeZone	String(4)	required	Time zone of the object which was saved as current. Possible meanings: <ul style="list-style-type: none"> <li>• 1 - One;</li> <li>• 2 - Two;</li> <li>• VR - One with reactive;</li> <li>• 4 - Four (Smart);</li> <li>• DR - Differentiated with reactive;</li> <li>• N - Not established.</li> </ul>
16.	newTariffPlan	String(200)	required	The new tariff plan of the object

No.	Attribute	type	obligation	description
17.	newTimeZone	String(4)	required	The new time zone of the object. Possible meanings: <ul style="list-style-type: none"> <li>• 1 - One;</li> <li>• 2 - Two;</li> <li>• VR - One with reactive;</li> <li>• 4 - Four (Smart);</li> <li>• DR - Differentiated with reactive;</li> <li>• N - Not established.</li> </ul>
18.	status	String(10)	required	Notification all status. Possible meanings: <ul style="list-style-type: none"> <li>• P - Submitted</li> <li>• A - Cancelled</li> <li>• I - Sent</li> <li>• V – In progress</li> <li>• IV - Completed</li> <li>• K - Error</li> </ul>
19.	statusDate	DateTime	required	Date of the status.

### 7.10.1.3 Error Response structure

The following table describes the JSON structure in the event of a response error:

No.	Attribute	type	obligation	description
1.	code	number	required	Error code.
2.	text	string(4000)	required	Error message.

### 7.10.2 POST /gateway/notification/contract/tariff-plan

<b>URL</b>	POST /gateway/notification/contract/tariff-plan		
<b>Description</b>	The method is for independent supplier to transfer the tariff plan change to DataHub.		
<b>Parameters</b>	<b>URL:</b> The data of the JSON form request are presented in the HTTP request body ( <b>BODY</b> ) (Query JSON structure, below).		
<b>Header</b>	After decrypting the supplier authentication key, the supplier ID is used to select the data.		
<b>Request</b>	<pre> {   "consentSign":"boolean",   "objects":[     {       "objectNumber":"string",       "newTariffPlan":"string",       "newTimeZone":"string"     }   ] } </pre>		
<b>Response HTTP codes</b>	<b>HTTP status code</b>	<b>Reason</b>	<b>Description</b>
	201	Created	Request completed successfully
	204	No Content	No data found according to the given parameters.
	400	Bad Request	Request error. The HTTP response body provides a list of errors in JSON format. ( <i>Error response of the JSON structure below</i> ).
	401	Unauthorized	An attempt was made to connect to a non-public method that requires authentication, but no user credentials were provided.
	403	Forbidden	According to the access control policy, the current user does not have access to perform the requested action.



	404	Not Found	Either there is no API method associated with the request URL path, or the request contains one or more parameters that did not return the data.		
<b>Response</b>	<pre>{   "notificationId": "number" }</pre>				
<b>JSON error response</b>	<pre>{   "errorMessages": [     {       "code": 0,       "text": "string"     }   ] }</pre>				
<b>Rules</b>	<b>No.</b>	<b>Rule description</b>	<b>Error code</b>	<b>Error message</b>	<b>Attributes</b>
	0.	If an attribute has defined possible values, the value index can be specified by specifying the value of the attribute in the request. Indices of all possible values start from 0.	-	-	-
	3.	The supplier will be identified by the authentication key.	1003	The independent supplier cannot be found in the system or supplier is not active.	-
	4.	The meaning of the [ObjectNumber] notification cannot be repeated.	7	The object: [objectNumber (if there is more than one object, objects must be separated by the semicolon)] is repeating.	objectNumber

5.	Must be specified valid object.	8	The object: [objectNumber (if there is more than one object, objects must be separated by the semicolon)] not found in the system.	objectNumber
6.	The object must belong to a valid supplier contract that provides the notification.	9	The object: [objectNumber (if there is more than one object, objects must be separated by the semicolon)] does not belong to a valid supplier contract.	objectNumber
7.	All objects of the notification must belong to the same contract.	43	Change not possible. Different contracts for submitted objects.	objectNumber
8.	It is possible to change the tariff plan of the object, if the possible date of changing the tariff plan is earlier than or equal to the current date.	302	Tariff plan changes are not possible. The object: [objectNumber (if there is more than one object, objects must be separated by the semicolon)] possible tariff plan change date is later than the current date.	objectNumber, tariffPlanChangeDate
9.	If the object contract type = SBTS, then the mandatory attribute is [newTariffPlan].	303	For the object: [objectNumber] it is mandatory to indicate the tariff plan.	newTariffPlan
10.	If the object contract type = SBTS, must be specified valid [newTariffPlan].	304	There is no tariff plan [newTariffPlan].	newTariffPlan
11.	If the object contract type = SBTS, then the meaning of the [newTariffPlan] attribute must be: <ul style="list-style-type: none"> <li>Namai or</li> </ul>	305	The object: [objectNumber] tariff plan must be "Namai" / "Namai plius" / "Standartinis" / "Išmanusis" / "Vidutinė įtampa".	newTariffPlan

	<ul style="list-style-type: none"> <li>• Namai plius or</li> <li>• Standartinis or</li> <li>• Išmanusis or</li> <li>• Vidutinė įtampa.</li> </ul>			
12.	If the object contract type = SBTS, then the new tariff plan must not coincide with the current tariff plan.	306	The object: [objectNumber] current tariff plan coincides with new tariff plan.	newTariffPlan
13.	If the object contract type = SBTS and the current tariff plan of object is "Vidutinė įtampa", then the new [newTariffPlan] must be "Vidutinė įtampa".	307	The object: [objectNumber] current tariff plan is "Vidutinė įtampa", then the new tariff plan must be "Vidutinė įtampa".	newTariffPlan
14.	If the object contract type =SBTS, then object tariffPlan=Vidutinė įtampa cannot be specified, if current tariffPlan of object is not "Vidutinė įtampa".	308	The object:[objectNumber] current tariff plan is not "Vidutinė įtampa", then the new tariff plan can be "Namai" / "Namai plius" / "Standartinis" / "Išmanusis".	newTariffPlan
15.	If the contractType=SKMS the attribute [newTariffPlan] must not be specified. The current tariff plan will be assigned to the object.	309	Contract type of the object: [objectNumber] is SKMS, the new tariff plan cannot be specified.	newTariffPlan
16.	The attribute [newTimeZone] is required.	-	-	newTimeZone

17.	<p>If the object contract type = SBTS and attribute [newTariffPlan] = Namai / Namai plius / Standartinis / Vidutinė įtampa, then the attribute [newTimeZone] meaning must be:</p> <ul style="list-style-type: none"> <li>• 1 or</li> <li>• 2.</li> </ul>	310	<p>If the object [objectNumber] the contract type is SBTS and the new tariff plan is "Namai" or "Namai plius" or "Standartinis" or "Vidutinė įtampa", then the new time zone must be One or Two.</p>	newTimeZone, newTariffPlan
18.	<p>If the object contract type = SBTS and attribute [newTariffPlan] = Išmanysis, then the attribute [newTimeZone] meaning must be:</p> <ul style="list-style-type: none"> <li>• 4.</li> </ul>	311	<p>If the object [objectNumber] the contract type is SBTS and the new tariff plan is "Išmanysis", then the new time zone must be "4 (Smart)".</p>	newTimeZone, newTariffPlan
19.	<p>If the object contractType=SKMS and PermissiblePowerConsumption &lt;= 30 kw, the attribute's [newTimeZone] possible values:</p> <ul style="list-style-type: none"> <li>• 1 or;</li> <li>• 2.</li> </ul>	312	<p>If the contractType=SKMS of the object: [objectNumber] and PermissiblePowerConsumption &lt;= 30 kw, than the new time zone must be "One" or "Two".</p>	newTimeZone

20.	<p>If the object contractType=SKMS and PermissiblePowerConsumption &gt; 30 kw, the attribute's [newTimeZone] possible values:</p> <ul style="list-style-type: none"> <li>• VR or;</li> <li>• DR.</li> </ul>	313	<p>If the contractType=SKMS of the object: [objectNumber] and PermissiblePowerConsumption &gt; 30 kw, then the new time zone must be "One with reactive" or "Differentiated with reactive ones".</p>	newTimeZone
21.	<p>The meaning of the [consentSign] must be:</p> <ul style="list-style-type: none"> <li>• True or</li> <li>• False.</li> </ul>	-	-	consentSign
22.	<p>If the attribute [consentSign] = False, then the tariff plan change must be disabled.</p>	32	<p>It is necessary to confirm that the data provided is correct.</p>	consentSign
23.	<p>Upon successful creation of a tariff plan change request, the status of the request becomes "Submitted".</p>	-	-	-
24.	<p>It is possible to change the tariff plan if the supply status of the object is T - Supplied. Otherwise, the change cannot be made.</p>	320	<p>Tariff plan change not possible. The object's: [objectNumber (if there is more than one object, objects must be separated by the semicolon)] supply status is not "T - Supplied".</p>	objectNumber

	25.	It must be checked whether the permissible power for use is specified for the object.	314	Failed to set usable power for the object [objectNumber].	objectNumber
--	-----	---	-----	---	--------------

### 7.10.2.1 JSON Request structure

The table below describes the structure of the JSON request:

No.	Attribute	type	obligation	description
1.	consentSign	Boolean	required	Indication of whether the data provided for the change of the tariff plan are correct. The default value is False.
2.	objects:[]			
3.	objectNumber	String(20)	required	Object number to whom was initiated tariff plan change.
4.	newTariffPlan	String(200)	not required	The new tariff plan can be specified only for the SBTS. In the case of SKMS, the current tariff plan is set automatically.
5.	newTimeZone	String(4)	required	The new time zone of the object. Possible meanings: <ul style="list-style-type: none"> <li>• 1 - One;</li> <li>• 2 - Two;</li> <li>• VR - One with reactive;</li> <li>• 4 - Four (Smart);</li> <li>• DR - Differentiated with reactive;</li> <li>• N - Not established.</li> </ul>

### 7.10.2.2 JSON Response structure

The table below describes the structure of the JSON response:

No.	Attribute	type	obligation	description
1.	notificationId	Integer	required	Identificatory of the notification.

### 7.10.2.3 Error Response structure

The following table describes the JSON structure in the event of a response error:

No.	Attribute	type	obligation	description
1.	code	number	required	Error code.
2.	text	string(4000)	required	Error message.

### 7.10.3 POST /gateway/notification/{notificationId}/contract/tariff-plan/cancel

<b>URL</b>	POST /gateway/notification/{notificationId}/contract/tariff-plan/cancel			
<b>Description</b>	The method is intended to cancel the tariff plan change.			
<b>Parameters</b>	<b>URL:</b> <ul style="list-style-type: none"> <li><b>notificationId</b> – Identificatory of the notification. Parameter is mandatory.</li> </ul>			
<b>Header</b>	After decrypting the supplier authentication key, the supplier ID is used to select the data.			
<b>Request</b>	There is no body in the JSON request.			
<b>Response HTTP codes</b>	<b>HTTP status code</b>	<b>Reason</b>	<b>Description</b>	

	201	Created	Request completed successfully		
	400	Bad Request	Request error. The HTTP response body provides a list of errors in JSON format. ( <i>Error response of the JSON structure below</i> ).		
	401	Unauthorized	An attempt was made to connect to a non-public method that requires authentication, but no user credentials were provided.		
	403	Forbidden	According to the access control policy, the current user does not have access to perform the requested action.		
	404	Not Found	Either there is no API method associated with the request URL path, or the request contains one or more parameters that did not return the data.		
<b>Response</b>					
<b>JSON error response</b>	<pre>{   "errorMessages": [     {       "code": 0,       "text": "string"     }   ] }</pre>				
<b>Rules</b>	<b>No.</b>	<b>Rule description</b>	<b>Error code</b>	<b>Error message</b>	<b>Attributes</b>
	0.	If an attribute has defined possible values, the value index can be specified by specifying the value of the attribute in the request. Indices of all	-	-	-



		possible values start from 0.			
1.	The request can be canceled:	<ul style="list-style-type: none"> <li>only one time;</li> <li>when the notification state is "Pateiktas";</li> <li>when the cancellation deadline has not passed (Initial value - 1 hour).</li> </ul>	50	According to the given parameters, the message to be canceled could not be found / the cancellation deadline has expired / the message has already been canceled.	-
2.	Upon successful cancellation of the tariff plan request, the status of the request becomes "Atšauktas".		-	-	-

### 7.10.3.1 JSON Request structure

The table below describes the structure of the JSON response:

No.	Attribute	type	obligation	description

### 7.10.3.2 JSON Response structure

The table below describes the structure of the JSON response:

No.	Attribute	type	obligation	description

### 7.10.3.3 Error Response structure

The following table describes the JSON structure in the event of a response error:

No.	Attribute	type	obligation	description
1.	code	number	required	Error code.
2.	text	string(4000)	required	Error message.

## 7.11 Notification contract contact controller *(will be deployed in the future)*

### 7.11.1 POST /gateway/notification/contract/contact/list?first={integer}&count={integer}&sortKey={string}&sortOrder={ASC/DSC}

<b>URI</b>	POST /gateway/notification/contract/contact/list?first={integer}&count={integer}&sortKey={string}&sortOrder={ASC/DSC}
<b>Description</b>	The method is to obtain a list of contact changes.
<b>Parameters</b>	<p><b>URL:</b></p> <ul style="list-style-type: none"> <li>• <b>first</b> - index (starting from 0) of the notification that must be presented first in the return list. Optional. The default value is 0.</li> <li>• <b>count</b> - number of objects in the return list. Optional. The default value is 30.</li> <li>• <b>sort</b> - possible values ASC, DSC.</li> </ul> <p>The data of the JSON form request are presented in the HTTP request body (<b>BODY</b>) (Query JSON structure, below).</p>
<b>Header</b>	After decrypting the supplier authentication key, the supplier ID is used to select the data.

<b>JSON request</b>	<pre>{   "notificationId":"number",   "personCode":"string",   "consumerCode":"string",   "objectNumber":"string",   "objectAddressSearch":"string",   "status":"string",   "submittedDateFrom":"datetime",   "submittedDateTo":"datetime",   "contractType":"string",   "newCorrespondenceAddressSearch":"string",   "newPhoneSearch":"string",   "newEmailSearch":"string",   "userNameSearch":"string" }</pre>		
<b>Response HTTP codes</b>	<b>HTTP status code</b>	<b>Reason</b>	<b>Description</b>
	200	OK	Request completed successfully.
	204	No Content	No data found according to the given parameters.
	400	Bad Request	Request error. The HTTP response body provides a list of errors in JSON format. ( <i>Error response of the JSON structure below</i> ).
	401	Unauthorized	An attempt was made to connect to a non-public method that requires authentication, but no user credentials were provided.
	403	Forbidden	According to the access control policy, the current user does not have access to perform the requested action.
	404	Not Found	Either there is no API method associated with the request URL path, or the request contains one or more parameters that did not return the data.
<b>JSON response</b>	<pre>[   {</pre>		

```
"notificationId":"number",
"personName":"string",
"personSurname":"string",
"personCode":"string",
"consumerCode":"string",
"contractType":"string",
"submittedDate":"datetime",
"latestStatus":"string",
"errorType":"string",
"userName":"string",
"newContact":{
  "newCorrespondenceAddress":"string",
  "newMobPhoneNoNetwork":"string",
  "newMobPhoneNo2Network":"string",
  "newPhoneNoNetwork":"string",
  "newMobPhoneNoInvoice":"string",
  "newEmailNetwork":"string",
  "newEmail2Network":"string",
  "newEmailInvoice":"string"
},
"contact":{
  "correspondenceAddress":"string",
  "mobPhoneNoNetwork":"string",
  "mobPhoneNo2Network":"string",
  "phoneNoNetwork":"string",
  "mobPhoneNoInvoice":"string",
  "emailNetwork":"string",
  "email2Network":"string",
  "emailInvoice":"string"
},
"objects":[
  {
```

```

    "objectNumber":"string",
    "objectAddress":"string",
    "newMobPhoneNoObject":"string",
    "mobPhoneNoObject":"string"
  }
],
"status":[
  {
    "status":"string",
    "statusDate":"datetime"
  }
]
}
]

```

**JSON error response**

```

{
  "errorMessages": [
    {
      "code": 0,
      "text": "string"
    }
  ]
}

```

Rules	No.	Rule description	Error code	Error message	Attributes
	0.	If an attribute has defined possible values, the value index can be specified by specifying the value of the attribute in the request. Indices of all possible values start from 0.	-	-	-
	1.	No data found according to the given parameters.	HTTP 204	-	-

	2.	DateFrom cannot be later than DateTo. Equal can be	1002	DateFrom cannot be later than DateTo.	submittedDateFrom, submittedDateTo
--	----	--	------	---------------------------------------	------------------------------------

### 7.11.1.1 JSON Request structure

The table below describes the structure of the JSON request:

No.	Atribute	Type	Obligation	Description
1.	notificationId	Integer	not required	Contact change notification ID.
2.	personCode	String(20)	not required	Contract owner / tenant person / company code.
3.	consumerCode	String(20)	not required	Contract owner / tenant consumer code.
4.	objectNumber	String(20)	not required	Object number.
5.	objectAddressSearch	String(4000)	not required	Object address. The search by the fragment.
6.	status	String(20)	not required	Notification status. Possible meanings: <ul style="list-style-type: none"> <li>• P - Submitted</li> <li>• A - Cancelled</li> <li>• I - Sent</li> <li>• V – In progress</li> <li>• IV - Completed</li> <li>• K - Error</li> </ul>
7.	submittedDateFrom	DateTime	not required	The submission date from of the notification. Format: yyyy-mm-dd
8.	submittedDateTo	DateTime	not required	The summation date to of the notification. Format: yyyy-mm-dd
9.	contractType	String(20)	not required	Contract type of the current object. Possible meanings: <ul style="list-style-type: none"> <li>• SBTS - Household customer;</li> </ul>

No.	Atributte	Type	Obligation	Description
				<ul style="list-style-type: none"> <li>SKMS - Commercial customer.</li> </ul>
10.	newCorrespondenceAddressSearch	String(4000)	not required	<ul style="list-style-type: none"> <li>Contract owner's / tenant's full name of correspondence address.</li> <li>Search by the fragment.</li> </ul>
11.	newPhoneSearch	String(4)	not required	<ul style="list-style-type: none"> <li>Search by the fragment.</li> <li>Searching for these contacts: <ul style="list-style-type: none"> <li>Contract owner's / tenant's new mobile phone number for the network.</li> <li>Contract owner's / tenant's new additional mobile phone number for the network.</li> <li>Contract owner's / tenant's new mobile phone number for the invoice.</li> <li>Contract owner's / tenant's new phone number for the network.</li> <li>Object's new mobile phone number for the network.</li> </ul> </li> </ul>
12.	newEmailSearch	string(100)	not required	<ul style="list-style-type: none"> <li>Search by the fragment.</li> <li>Searching for these contacts: <ul style="list-style-type: none"> <li>Contract owner's / tenant's new email address for the network;</li> <li>Contract owner's / tenant's new additional email address for the network.</li> <li>Contract owner's / tenant's new email address for the invoice;</li> </ul> </li> </ul>
13.	userNameSearch	String(240)	not required	The user who created a notification. Search by the fragment.

### 7.11.1.2 JSON Response structure

The table below describes the structure of the JSON response:

No.	Attribute	Type	Obligation	Description
1.	notificationId	integer	required	Contact change notification ID.
2.	personName	string(200)	required	Contract owner / tenant / company name.
3.	personSurname	string(50)	not required	Contract owner / tenant surname.
4.	personCode	string(15)	required	Contract owner / tenant person / company code.
5.	consumerCode	string(20)	required	Contract owner / tenant consumer code.
6.	contractType	string(10)	required	Contract type of the current object. Possible meanings: <ul style="list-style-type: none"> <li>• SBTS - Household customer;</li> <li>• SKMS - Commercial customer.</li> </ul>
7.	submittedDate	DateTime	required	The submission date of the notification
8.	latestStatus	string(10)	required	Notification newest status. Possible meanings: <ul style="list-style-type: none"> <li>• P - Submitted</li> <li>• A - Cancelled</li> <li>• I - Sent</li> <li>• V – In progress</li> <li>• IV - Completed</li> <li>• K - Error</li> </ul>
9.	errorType	String(10)	not required	Notification error type if status=K (Error).
10.	userName	string(240)	required	The user who initiates the contact change notification
newContact{}				
11.	newCorrespondenceAddress	string(4000)	required	Contract owner's / tenant's full name of new correspondence address.
12.	newMobPhoneNoNetwork	string(12)	not required	Contract owner's / tenant's new mobile phone number for the network.



No.	Attribute	Type	Obligation	Description
13.	newMobPhoneNo2Network	string(12)	not required	Contract owner's / tenant's new additional mobile phone number for the network.
14.	newPhoneNoNetwork	string(12)	not required	Contract owner's / tenant's new phone number for the network.
15.	newMobPhoneNoInvoice	string(12)	not required	Contract owner's / tenant's new mobile phone number for the invoice.
16.	newEmailNetwork	string(49)	not required	Contract owner's / tenant's new email address for the network.
17.	newEmail2Network	string(49)	not required	Contract owner's / tenant's new additional email address for the network.
18.	newEmailInvoice	string(100)	not required	Contract owner's / tenant's new email address for the invoice.
contact: {}				
19.	correspondenceAddress	string(4000)	not required	Contract owner's / tenant's full name of correspondence address.
20.	mobPhoneNoNetwork	string(12)	not required	Contract owner's / tenant's mobile phone number for the network.
21.	mobPhoneNo2Network	string(12)	not required	Contract owner's / tenant's additional mobile phone number for the network.
22.	phoneNoNetwork	string(12)	not required	Contract owner's / tenant's phone number for the network.
23.	mobPhoneNoInvoice	string(12)	not required	Contract owner's / tenant's mobile phone number for the invoice.
24.	emailNetwork	string(49)	not required	Contract owner's / tenant's email address for the network.
25.	email2Network	string(49)	not required	Contract owner's / tenant's additional email address for the network.
26.	emailInvoice	string(100)	not required	Contract owner's / tenant's email address for the invoice.
objects: []				
27.	objectNumber	string(20)	required	Contract object number.
28.	objectAddress	string(4000)	required	Full name of the contract object address.
29.	newMobPhoneNoObject	string(12)	not required	Object's new mobile phone number for the network.

No.	Attribute	Type	Obligation	Description
30.	mobPhoneNoObject	string(12)	not required	Object's mobile phone number for the network.
status:[]				
31.	status	String(10)	required	Notification newest status. Possible meanings: <ul style="list-style-type: none"> <li>• P - Submitted</li> <li>• A - Cancelled</li> <li>• I - Sent</li> <li>• V – In progress</li> <li>• IV - Completed</li> <li>• K - Error</li> </ul>
32.	statusDate	DateTime	required	Notification status date.

### 7.11.1.3 Error Response structure

The following table describes the JSON structure in the event of a response error:

No.	Attribute	Type	Obligation	Description
1.	code	number	required	Error code.
2.	text	string(4000)	required	Error message.

### 7.11.2 POST /gateway/notification/contract/contact

<b>URI</b>	POST /gateway/notification/contract/contact
<b>Description</b>	The method is for independent supplier to transfer the contact change to DataHub.

<b>Parameters</b>	<p><b>URI:</b></p> <p>The data of the JSON form request are presented in the HTTP request body (<b>BODY</b>) (Query JSON structure, below).</p>
<b>Header</b>	<p>After decrypting the supplier authentication key, the supplier ID is used to select the data.</p>
<b>JSON request</b>	<pre> {   "consumerCode":"string",   "consentSign":"boolean",   "newCorrespondenceAddress":{     "newStreet":"string",     "newBuilding":"string",     "newHousingNo":"string",     "newAppartement":"string",     "newLocality":"string",     "newEldership":"string",     "newMunicipality":"string",     "newCounty":"string"   },   "newContact":{     "newMobPhoneNoNetwork":"string",     "newMobPhoneNo2Network":"string",     "newMobPhoneNoInvoice":"string",     "newPhoneNoNetwork":"string",     "newEmailNetwork":"string",     "newEmail2Network":"string",     "newEmailInvoice":"string"   },   "objects":[     {       "objectNumber":"string",       "newMobPhoneNoObject":"string"     }   ] } </pre>

	<pre> ] } </pre>				
Response HTTP codes	HTTP status code	Reason	Description		
	201	Created	Request completed successfully		
	400	Bad Request	Request error. The HTTP response body provides a list of errors in JSON format. ( <i>Error response of the JSON structure below</i> ).		
	401	Unauthorized	An attempt was made to connect to a non-public method that requires authentication, but no user credentials were provided.		
	403	Forbidden	According to the access control policy, the current user does not have access to perform the requested action.		
	404	Not Found	Either there is no API method associated with the request URL path, or the request contains one or more parameters that did not return the data.		
JSON response	<pre> {   "notificationId": "number" } </pre>				
JSON error response	<pre> {   "errorMessages": [     {       "code": 0,       "text": "string"     }   ] } </pre>				
Rules	No.	Rule description	Error	Error message	Attributes

		code		
0.	If an attribute has defined possible values, the value index can be specified by specifying the value of the attribute in the request. Indices of all possible values start from 0.	-	-	-
1.	The supplier will be identified by the authentication key.	1003	The independent supplier cannot be found in the system or supplier is not active.	-
2.	The attribute consumerCode is mandatory.	-	-	consumerCode
3.	The change of contacts can only be performed for the contract that is valid at the moment and the objects of the contract belong to the supplier initiating the change.	410	Change not possible. No valid contract found.	consumerCode
4.	If the contract type = SBTS, then must be at least one contact attribute: <ul style="list-style-type: none"> <li>• [newMobPhoneNoNetwork] or</li> <li>• [newTelPhoneNoNetwork] or</li> <li>• [newEmailNetwork]</li> </ul>	415	If the contract type is "SBTS", it is mandatory to specify at least one attribute: "Mob. phone no." or "Phone no." or "Email address".	newMobPhoneNoNetwork, newEmailNetwork, newTelPhoneNoNetwork
5.	If the contract type = SKMS, then must be at least one contact attribute: <ul style="list-style-type: none"> <li>• [newMobPhoneNoNetwork] or</li> <li>• [newTelPhoneNoNetwork] or</li> <li>• [newEmailNetwork].</li> </ul> and <b>one of</b> contacts for the invoices; <ul style="list-style-type: none"> <li>• [newMobPhoneNoInvoice] or</li> </ul>	416	If the contract type is "SKMS", it is mandatory to specify one of the contacts for network work: "Mob. phone no." or "Phone no." or "Email Address" and <b>one of the</b> contacts for accounts: "Mob. phone no." or "Email Address".	newMobPhoneNoNetwork, newEmailNetwork, newMobPhoneNoInvoice, newEmailInvoice, newTelPhoneNoNetwork

	<ul style="list-style-type: none"> <li>[newEmailInvoice].</li> </ul>			
6.	If the contract type=SBTS then attributes [newMobPhoneNoInvoice] and [newEmailInvoice] cannot be filled.	417	If the contract type "SBTS", then invoice "Mob. phone No." and invoice "Email address" cannot be filled.	newMobPhoneNoInvoice, newEmailInvoice
7.	<p>The format of the attributes [newMobPhoneNoNetwork], [newMobPhoneNo2Network], [newMobPhoneNoInvoice] must be : +3706XXXXXXXX, X - an integer (0 must be included).</p> <p>The format of the attribute [newPhoneNoNetwork] must be : +370XXXXXXXX, X - an integer (0 must be included).</p>	418	"Mob. phone No.", "Mob. phone No. (optional)" and "Phone no." incorrect format.	newMobPhoneNoNetwork, newMobPhoneNo2Network, newMobPhoneNoInvoice, newPhoneNoNetwork
8.	<p>The format of the attributes [newEmailNetwork], [newEmail2Network], [newEmailInvoice] must be [text][@][text][.domain], letters in the text must be Latin.</p> <p>Can be at most 64 characters up to @ symbol.</p>	419	An "Email address" and "Email address (optional)" incorrect format.	newEmailNetwork, newEmail2Network, newEmailInvoice
9.	The attributes [objectNumber] and [newMobPhoneObject] are only filled in if the contract type is SKMS.	411	The contract type is not SKMS, so the attributes "Object No." and "Mobile Phone No." must be left blank.	objectNumber, newMobPhoneNoObject
10.	The attribute [ObjectNumber] is mandatory if the attribute [newMobPhoneNoObject] is not null.	412	Attribute "Object No." is required if the attribute "Mobile phone number" is used.	objectNumber, newMobPhoneNoObject

11.	The meaning of the [ObjectNumber] notification cannot be repeated.	421	The object: <b>[objectNumber]</b> is repeating.	objectNumber
12.	Must be specified valid object.	422	The object: [objectNumber] not found in the system.	objectNumber
13.	The object must belong to a valid supplier contract that provides the notification.	423	The object: [objectNumber] does not belong to a valid supplier contract.	objectNumber
14.	All objects of the notification must belong to the same contract.	413	Change not possible. Different contracts for submitted objects.	objectNumber
15.	All notification's objects must belong to the provided user code.	420	Change not possible. Object [objectNumber] does not belong to user code [consumerCode].	objectNumber, consumerCode
16.	The format of the attribute [newMobPhoneNoObject] must be : +3706XXXXXXX, X - an integer (0 must be included).	414	"Mob. phone No." incorrect format.	newMobPhoneNoObject
17.	The meaning of the [consentSign] must be: <ul style="list-style-type: none"> <li>• True or</li> <li>• False.</li> </ul>	-	-	consentSign
18.	If the attribute [consentSign] = False, then the tariff plan change must be disabled.	32	It is necessary to confirm that the data provided is correct.	consentSign

	19.	Upon successful creation of a contact change request, the status of the request becomes "Submitted".	-	-	-
--	-----	--	---	---	---

### 7.11.2.1 JSON Request structure

The table below describes the structure of the JSON request:

No.	Attribute	Type	Obligation	Description
1.	consumerCode	Strign(20)	required	Contract owner / tenant consumer code.
2.	consentSign	Boolean	required	Indication that the contact change data provided are correct. The default value is False.
newcorrespondenceAddress: {}				
3.	newStreet	Varchar(200)	N	New correspondence address's street.
4.	newBuilding	Varchar(100)	N	New correspondence address's number of the house.
5.	newHousingNo	Varchar(100)	N	New Correspondence Address's Corps Number.
6.	newAppartment	Varchar(20)	N	New correspondence address's apartment number.
7.	newLocality	Varchar(200)	N	New correspondence address's city / village.
8.	newEldership	Varchar(200)	N	New correspondence address's eldership.
9.	newMunicipality	Varchar(200)	N	New correspondence address's municipality.
10.	newCounty	Varchar(200)	N	New Correspondence Address's County.
newContact: {}				
11.	newMobPhoneNoNetwork	Varchar(12)	N	Contract owner's / tenant's new mobile phone number for the network.
12.	newMobPhoneNo2Network	Varchar(12)	N	Contract owner's / tenant's new additional mobile phone number for the network.



No.	Attribute	Type	Obligation	Description
13.	newMobPhoneNoInvoice	Varchar(12)	N	Contract owner's / tenant's new mobile phone number for the invoice.
14.	newPhoneNoNetwork	Varchar(12)	N	Contract owner's / tenant's new phone number for the network.
15.	newEmailNetwork	Varchar(49)	N	Contract owner's / tenant's new email address for the network.
16.	newEmail2Network	Varchar(49)	N	Contract owner's / tenant's new additional email address for the network.
17.	newEmailInvoice	Varchar(100)	N	Contract owner's / tenant's new email address for the invoice.
object:[] Filled in only in case of SKMS				
18.	objectNumber	Varchar(20)	N	Contract object number.
19.	newMobPhoneNoObject	Varchar(12)	N	Object's new mobile phone number for the network.

#### 7.11.2.2 JSON Response structure

The table below describes the structure of the JSON response:

No.	Attribute	Type	Obligation	Description
1.	notificationId	Integer	required	Notification ID.

#### 7.11.2.3 Error Response structure

The following table describes the JSON structure in the event of a response error:

No.	Attribute	Type	Obligation	Description
1.	code	number	required	Error code.

No.	Attribute	Type	Obligation	Description
2.	text	string(4000)	required	Error message.

### 7.11.3 POST /gateway/notification/{notificationId}/contract/contact/cancel

<b>URI</b>	POST /gateway/notification/{notificationId}/contract/contact/cancel			
<b>Description</b>	The method is intended to cancel the contact change.			
<b>Parameters</b>	<b>URL:</b> <ul style="list-style-type: none"> <li>• <b>notificationId</b> – notification identifier. Mandatory</li> </ul>			
<b>Header</b>	The data of the JSON form request are presented in the HTTP request body ( <b>BODY</b> ) (Query JSON structure, below).			
<b>JSON request</b>	There is no body in the JSON request.			
<b>Response HTTP codes</b>	<b>HTTP status codes</b>	<b>Reason</b>	<b>Description</b>	
	201	Created	Request completed successfully	
	400	Bad Request	Request error. The HTTP response body provides a list of errors in JSON format. ( <i>Error response of the JSON structure below</i> ).	
	401	Unauthorized	An attempt was made to connect to a non-public method that requires authentication, but no user credentials were provided.	

	403	Forbidden	According to the access control policy, the current user does not have access to perform the requested action.		
	404	Not Found	Either there is no API method associated with the request URL path, or the request contains one or more parameters that did not return the data.		
<b>JSON response</b>					
<b>JSON error response</b>	<pre> {   "errorMessages":   [     {       "code": 0,       "text": "string"     }   ] } </pre>				
<b>Rule</b>	<b>No.</b>	<b>Rule description</b>	<b>Error code</b>	<b>Error message</b>	<b>Attributes</b>
	0.	If an attribute has defined possible values, the value index can be specified by specifying the value of the attribute in the request. Indices of all possible values start from 0.	-	-	-
	1.	<p>The request can be canceled:</p> <ul style="list-style-type: none"> <li>only one time;</li> <li>when the notification state is "Pateiktas";</li> </ul> <p>when the cancellation deadline has not passed (Initial value - 1 hour).</p>	50	According to the given parameters, the message to be canceled could not be found / the cancellation deadline has expired / the message has already been canceled.	-
	2.	Upon successful cancellation of the contact request, the status of the request becomes "Atšauktas".	-	-	-

### 7.11.3.1 JSON Request structure

The table below describes the structure of the JSON request:

No.	Attribute	Type	Obligation	Description
1.				

### 7.11.3.2 JSON Response structure

The table below describes the structure of the JSON response:

No.	Attribute	Type	Obligation	Description
1.				

### 7.11.3.3 Error Response structure

The following table describes the JSON structure in the event of a response error:

No.	Attribute	Type	Obligation	Description
1.	code	number	required	Error code.
2.	text	string(4000)	required	Error message.

## 7.12 Order controller

### 7.12.1 POST/gateway/order/list?first={integer}&count={integer}&sortKey={string}&sortOrder={ASC/DSC}

<b>URI</b>	POST/gateway/order/list?first={integer}&count={integer}&sortKey={string}&sortOrder={ASC/DSC}
<b>Description</b>	Method will return list of the orders.
<b>Parameters</b>	URL parameters:

	<p>first - the index of the report line, which must be the first in the return list (starting from 0). Optional. The default value is 0.</p> <p>count - the number of order's rows in the return list. Optional. The default value is 30. <a href="#">If no count value is given, the default value count will be 30.</a></p> <p>sort – ASC, DSC sorting.</p> <p>-By default, the reports' orders list must be sorted by the orderId;</p>		
<b>Header</b>	After decrypting the supplier authentication key, the supplier ID is used to select the data.		
<b>JSON request</b>	<pre>{   "orderId": "number",   "orderTypes": ["string"],   "submittedDateFrom": "date",   "submittedDateTo": "date",   "dateFrom": "date",   "dateTo": "date",   "status": "string",   "auto": "boolean",   "userNameSearch": "string",   "orderParametersSearch": "string" }</pre>		
<b>Response</b>	<b>HTTP status code</b>	<b>Reason</b>	<b>Response description</b>
	200	OK	Request completed successfully
	204	No content	No data found according to the given parameters.
	400	Bad Request	Request error. The HTTP response body provides a list of errors in JSON format.
	401	Unauthorized	An attempt was made to connect to a non-public method that requires authentication, but no user credentials were provided.
	403	Forbidden	According to the access control policy, the current user does not have access to perform the requested action.
	404	Not Found	Either there is no API method associated with the request URL path, or the request contains one or more parameters that did not return the data.

<b>JSON Response</b>	<pre>[   {     "orderId": "number",     "orderType": "string",     "submittedDate": "datetime",     "dateFrom": "date",     "dateTo": "date",     "orderParameters": "string",     "latestStatus": "string",     "statusDate": "datetime",     "expireDate": "datetime",     "auto": "boolean",     "userName": "string"   } ]</pre>				
<b>JSON error response</b>	<pre>{   "errorMessages": [     {       "code": 0,       "text": "string"     }   ] }</pre>				
<b>Rules</b>	<b>No.</b>	<b>Rule description</b>	<b>Error code</b>	<b>Error message</b>	<b>Attribute</b>
0.	If an attribute has defined possible values, the value index can be specified by specifying the value of the attribute in the request. Indices of all possible values start from 0.	-	-	All attributes with specified values.	
1.	DateFrom cannot be later than DateTo. Equal can be.	1002	DateFrom cannot be later than DateTo.	dateFrom	
2.	Submitted date cannot be later than the current date but can be equal.	2004	Submitted date cannot be later than the current date.	submittedDateTo	

	3.	Submitted date from cannot be later than the submitted date to, but can be equal.	2005	Submitted date from cannot be later than submitted date to.	submittedDateFrom submittedDateTo
	4.	Date format is incorrect.	-	-	dateFrom dateTo submittedDateFrom submittedDateTo

### 7.12.1.1 JSON Request structure

The table below describes the structure of the JSON response:

Attribute	type	obligation	description
orderId	Integer	Not required	Order ID.
orderTypes	String	Not required	The short name of the order type. Possible meanings: <ul style="list-style-type: none"> <li>• data-hr-15min-mtr-lvl - Automated quantities at the meter level (Automatizuoti kiekiai skaitiklio lygyje);</li> <li>• data-hr-15min-obj-lvl - Automated quantities at the object level (Automatizuoti kiekiai objekto lygyje);</li> <li>• bill-2s2s-b2b - Billing report for 2S2S model B2B (Sąskaitybos ataskaita 2S2S modeliui B2B);</li> <li>• bill-bss-b2b - Billing report for BSS model B2B (Sąskaitybos ataskaita BSS modeliui B2B);</li> <li>• bill-bss-b2c - Billing report for BSS model B2C (Sąskaitybos ataskaita BSS modeliui B2C);</li> <li>• report-obj - Objects report (Objektų ataskaita).</li> </ul>
submittedDateFrom	Date	Not required	Order's submission date from. <ul style="list-style-type: none"> <li>• The format of the date: YYYY-MM-DD.</li> </ul>
submittedDateTo	Date	Not required	Order's submission date to.
dateFrom	Date	Not required	The beginning of the reporting period: <ul style="list-style-type: none"> <li>• The format: YYYY-MM-DD;</li> <li>• The reporting period start date is the first day of the month.</li> </ul>

dateTo	Date	Not required	The end of the reporting period: <ul style="list-style-type: none"> <li>• The format: YYYY-MM-DD;</li> <li>• The reporting period end date is the last day of the month.</li> </ul>
status	String(20)	Not required	The status of the order. Possible meanings: <ul style="list-style-type: none"> <li>• IV – Completed;</li> <li>• V – In progress;</li> <li>• P – Submitted;</li> <li>• K – Error.</li> </ul>
auto	Boolean	Not required	Indication that the order was ordered automatically.
userNameSearch	String(240)	Not required	The user who ordered the order.
orderParametersSearch	String	Not required	The order parameters.

#### 7.12.1.2 JSON Response structure

The table below describes the structure of the JSON response:

Attribute	type	obligation	description
orderId	Integer	required	Order ID.
orderType	String(100)	required	The short name of the order type. Possible meanings: <ul style="list-style-type: none"> <li>• data-hr-15min-mtr-lvl - Automated quantities at the meter level (Automatizuoti kiekiai skaitiklio lygyje);</li> <li>• data-hr-15min-obj-lvl - Automated quantities at the object level (Automatizuoti kiekiai objekto lygyje);</li> <li>• bill-2s2s-b2b - Billing report for 2S2S model B2B (Sąskaitybos ataskaita 2S2S modeliui B2B);</li> <li>• bill-bss-b2b - Billing report for BSS model B2B (Sąskaitybos ataskaita BSS modeliui B2B);</li> <li>• bill-bss-b2c - Billing report for BSS model B2C (Sąskaitybos ataskaita BSS modeliui B2C);</li> <li>• report-obj - Objects report (Objektų ataskaita).</li> </ul>
submittedDate	Datetime	required	The date of the order submission.
dateFrom	Date	required	The beginning of the reporting period:



			<ul style="list-style-type: none"> <li>• The format: YYYY-MM-DD;</li> <li>• The reporting period start date is the first day of the month;</li> <li>• If the ordered report is Object Automated Consumptions, dateFrom can be not only the first day of the month.</li> </ul>
dateTo	Date	required	<p>The end of the reporting period:</p> <ul style="list-style-type: none"> <li>• The format: YYYY-MM-DD;</li> <li>• The reporting period end date is the last day of the month;</li> <li>• If the ordered report is Object Automated Consumptions, dateTo can be not only the last day of the month.</li> </ul>
orderParameters	String(4000)	required	The search parameters by which the data in the ordered order was filtered.
latestStatus	String(20)	required	The current status of the order.
statusDate	Datetime	required	The latest status date.
expireDate	Datetime	required	<p>Date of validity of the order.</p> <ul style="list-style-type: none"> <li>• The ordered report with <b>status = Completed</b> by default, is available only for 24 hours;</li> <li>• The report, which was generated automatically by default, is available for 12 months.</li> </ul>
auto	Boolean	required	Indication that the report order was ordered automatically.
usreName	String(240)	required	The user who ordered the order.

### 7.12.1.3 Error Response Structure

The following table describes the JSON structure in the event of a response error:

No.	Attribute	type	obligation	description
1.	code	number	required	Error code.
2.	text	string(4000)	required	Error message.

### 7.12.2 POST/gateway/order/{hr15OrderShortName}

<b>URI</b>	POST/gateway/order/{hr15OrderShortName}		
<b>Description</b>	Method will order the chosen report.		
<b>Parameters</b>	<p>URL parameters:</p> <ul style="list-style-type: none"> <li>hr15OrderShortName – the method is used for specified report type: <ul style="list-style-type: none"> <li><b>data-hr-15min-mtr-lvl</b> - Automated quantities at the meter level (Automatizuoti kiekiai skaitiklio lygyje);</li> <li><b>data-hr-15min-obj-lvl</b> - Automated quantities at the object level (Automatizuoti kiekiai objekto lygyje);</li> </ul> </li> </ul> <p>The data of the JSON form request are presented in the HTTP request body (BODY) (Query JSON structure, below).</p>		
<b>Header</b>	After decrypting the supplier authentication key, the supplier ID is used to order the report.		
<b>JSON request</b>	<pre>{   "dateFrom": "date",   "dateTo": "date",   "consumptionCategories":[string, string],   "objectNumber":[string, string],   "interval":"string" }</pre>		
<b>Response</b>	<b>HTTP status code</b>	<b>Reason</b>	<b>Response description</b>
	201	Created	Request completed successfully
	400	Bad Request	Request error. The HTTP response body provides a list of errors in JSON format.
	401	Unauthorized	An attempt was made to connect to a non-public method that requires authentication, but no user credentials were provided.
	403	Forbidden	According to the access control policy, the current user does not have access to perform the requested action.
	404	Not Found	Either there is no API method associated with the request URL path, or the request contains one or more parameters that did not return the data.

<b>JSON Response</b>	<pre>{   "orderId": "number" }</pre>				
<b>JSON error response</b>	<pre>{   "errorMessages": [     {       "code": 0,       "text": "string"     }   ] }</pre>				
<b>Rules</b>	<b>No.</b>	<b>Rule description</b>	<b>Error code</b>	<b>Error message</b>	<b>Attribute</b>
	0.	If an attribute has defined possible values, the value index can be specified by specifying the value of the attribute in the request. Indices of all possible values start from 0.	-	-	All attributes with specified values.
	1.	One or more request parameters are required.	1001	One or more request parameters are required.	dateFrom dateTo objectNumber orderDataGroupBy
	2.	DateFrom cannot be later than DateTo. Equal can be.	1002	DateFrom cannot be later than DateTo.	dateFrom
	3.	The date from cannot be later than the current date but can be equal.	2003	Date from cannot be later than the current date.	dateFrom
	4.	Date format is incorrect.	-	-	dateTo dateFrom
	5.	Client information cannot be older than 36 months old.	2012	DateFrom date cannot be older than 36 months old.	dateFrom
	6.	Report can be ordered maximum for 12 months.	2013	The report can only be ordered for 12 months or less.	dateTo

	7.	A maximum of 500 objects can be submitted in a report order	2021	A maximum of 500 objects can be specified.	objectNumber
	8.	The period dateFrom and dateTo must be less than date from configurable parameter.	2015	Data is not currently available for the selected reporting period.	dateFrom dateTo
	9.	Start and end dates are required.	1004	Dates are required.	dateFrom dateTo
	10.	The submitted object number: [...], was not found or the meter of object is not automated.	2007	Object meter must be automated.	objectNumbers

### 7.12.2.1 JSON Request structure

The table below describes the structure of the JSON response:

Attribute	type	obligation	description
dateFrom	Date	Required	The consumption period first day: <ul style="list-style-type: none"> <li>The format: YYYY-MM-DD.</li> </ul>
dateTo	Date	Required	The consumption period last day: <ul style="list-style-type: none"> <li>The format: YYYY-MM-DD.</li> </ul>
consumptionCategory	String(20)	Required	The consumption category. Possible meanings: <ul style="list-style-type: none"> <li>P+;</li> <li>P-;</li> <li>Q+;</li> <li>Q-.</li> </ul>
objectNumber	String(20)	Required	Object number.
interval	String(20)	Required	Consumption interval. Possible meanings: <ul style="list-style-type: none"> <li>- HOUR</li> <li>- QUARTER</li> </ul>

### 7.12.2.2 JSON Response structure

The table below describes the structure of the JSON response:

Attribute	type	obligation	description
orderId	Integer	required	Report's order ID.

### 7.12.2.3 Error Response Structure

The following table describes the JSON structure in the event of a response error:

No.	Attribute	type	obligation	description
1.	code	number	required	Error code.
2.	text	string(4000)	required	Error message.

### 7.12.3 POST/gateway/order/{orderShortName}

<b>URI</b>	POST/gateway/order/{orderShortName}
<b>Description</b>	Method will order the chosen report.
<b>Parameters</b>	<p>URL parameters:</p> <ul style="list-style-type: none"> <li>• <b>orderShortName</b> – the method is used for specified report type. <ul style="list-style-type: none"> <li>• <b>bill-2s2s-b2b</b> - Billing report for 2S2S model B2B (Šąskaitybės ataskaita 2S2S modeliui B2B);</li> <li>• <b>bill-bss-b2b</b> - Billing report for BSS model B2B (Šąskaitybės ataskaita BSS modeliui B2B);</li> <li>• <b>bill-bss-b2c</b> - Billing report for BSS model B2C (Šąskaitybės ataskaita BSS modeliui B2C);</li> <li>• <b>report-obj</b> - Objects report (Objektų ataskaita).</li> </ul> </li> </ul>
<b>Header</b>	After decrypting the supplier authentication key, the supplier ID is used to order the report.
<b>JSON request</b>	<pre>{   "dateFrom": "date",   "dateTo": "date",   "consumerCode": "string",   "personCode": "string",   "objectNumbers":["string"],</pre>

	<pre>"contractType": "string" }</pre>				
<b>Response</b>	<b>HTTP status code</b>	<b>Reason</b>	<b>Response description</b>		
	201	Created	Request completed successfully		
	400	Bad Request	Request error. The HTTP response body provides a list of errors in JSON format.		
	401	Unauthorized	An attempt was made to connect to a non-public method that requires authentication, but no user credentials were provided.		
	403	Forbidden	According to the access control policy, the current user does not have access to perform the requested action.		
	404	Not Found	Either there is no API method associated with the request URL path, or the request contains one or more parameters that did not return the data.		
<b>JSON Response</b>	<pre>{   "orderId": "number" }</pre>				
<b>JSON error response</b>	<pre>{   "errorMessages": [     {       "code": 0,       "text": "string"     }   ] }</pre>				
<b>Rules</b>	<b>No.</b>	<b>Rule description</b>	<b>Error code</b>	<b>Error message</b>	<b>Attribute</b>
	0.	If an attribute has defined possible values, the value index can be specified by specifying the value of the attribute in the request. Indices of all possible values start from 0.	-	-	All attributes with specified values.

1.	The report of the specified object can be ordered only if the object was or is owned for the supplier in the chosen period. Checking whether the objects were valid with the supplier during the specified period.	2001	There are no owned objects for the selected period or other specified search parameters.	dateFrom dateTo consumerCode objectNumber personCode
2.	One or more request parameters are required.	1001	One or more request parameters are required.	dateFrom dateTo
3.	DateFrom cannot be later than DateTo. Equal can be.	1002	DateFrom cannot be later than DateTo.	dateFrom
4.	The date from cannot be later than the current date but can be equal. <i>This rule should not apply to a [report-obj] report, as a result of which the data may be later than the current date.</i>	2003	Date from cannot be later than the current date.	dateFrom
5.	Date format is incorrect.	-	-	dateTo dateFrom
6.	The contract type can be specified only for the Object Data Collection report. The contract type cannot be specified for the other order types.	2008	The search parameter <b>[contractType]</b> is not applicable to the selected report order type.	contractType
7.	The report order can be done only for one reporting period (one month). <ul style="list-style-type: none"> <li>This rule cannot be applies for <b>[report-obj]</b> report.</li> </ul>	2011	The report can be ordered only for one month.	dateFrom dateTo
8.	Client information cannot be older than 36 months old.	2012	DateFrom date cannot be older than 36 months old.	dateFrom
9.	The period dateFrom and dateTo must be less than date from configurable parameter.	2015	Data is not currently available for the selected reporting period.	dateFrom dateTo
10.	Start and end dates are required.	1004	Dates are required.	dateFrom dateTo
11.	The object data pack can be ordered 36 months to the future.	2019	The report can be ordered 36 months to the future.	dateTo

12.	A maximum of 500 objects can be submitted in a report order	2021	A maximum of 500 objects can be specified.	objectNumber
-----	---	------	--	--------------

### 7.12.3.1 JSON Request structure

The table below describes the structure of the JSON response:

Attribute	type	obligation	description
dateFrom	Date	Required	The beginning of the reporting period: <ul style="list-style-type: none"> <li>The format: YYYY-MM-DD;</li> <li>The reporting period start date is the first day of the month.</li> </ul>
dateTo	Date	Required	The end of the reporting period: <ul style="list-style-type: none"> <li>The format: YYYY-MM-DD;</li> <li>The reporting period end date is the last day of the month.</li> </ul>
consumerCode	String(20)	Not required	Consumer code.
personCode	String(20)	Not required	Person or the company code.
objectNumbers	String	Not required	Object numbers.
contractType	String(10)	Not required	Contract type. Possible meanings: <ul style="list-style-type: none"> <li>SKMS;</li> <li>SBTS.</li> </ul>

### 7.12.3.2 JSON Response structure

The table below describes the structure of the JSON response:

Attribute	type	obligation	description
orderId	Integer	required	Report's order ID.

### 7.12.3.3 Error Response Structure

The following table describes the JSON structure in the event of a response error:



No.	Attribute	type	obligation	description
1.	code	number	required	Error code.
2.	text	string(4000)	required	Error message.

#### 7.12.4 GET/gateway/order/{orderId}/data-hr-15min-obj-lvl

<b>URI</b>	GET/gateway/order/{orderId}/data-hr-15min-obj-lvl		
<b>Description</b>	The method is designed to obtain fifteen minute / hour report data.		
<b>Parameters</b>	<p>URL parameters:</p> <p><b>orderId</b> – order identification number</p> <p><b>first</b> - the index of the object, which must be the first in the return list (starting from 0). Optional. The default value is 0.</p> <p><b>count</b> - the number of objects in the return list. Optional. <a href="#">The default value is 10000. If no count value is given, the default value count will be 10000.</a></p>		
<b>Header</b>	After decrypting the supplier authentication key, the supplier ID is used to select the data.		
<b>JSON request</b>	GET request does not have the BODY part.		
<b>Response</b>	<b>HTTP status code</b>	<b>Reason</b>	<b>Response description</b>
	200	OK	Request completed successfully
	204	No content	No data found according to the given parameters.
	400	Bad Request	Request error. The HTTP response body provides a list of errors in JSON format.
	401	Unauthorized	An attempt was made to connect to a non-public method that requires authentication, but no user credentials were provided.

	403	Forbidden	According to the access control policy, the current user does not have access to perform the requested action.		
	404	Not Found	Either there is no API method associated with the request URL path, or the request contains one or more parameters that did not return the data.		
<b>JSON Response</b>	<pre>[   {     "personCode":"string",     "personName":"string",     "personSurname":"string",     "objectId":"number",     "objectNumber":"string",     "categories":[       {         "consumptionCategory":"string",         "consumptions":[           {             "consumptionTime":"datetime",             "amount":"double"           }         ]       }     ]   } ]</pre>				
<b>JSON error response</b>	<pre>{   "errorMessages": [     {       "code": 0,       "text": "string"     }   ] }</pre>				
<b>Rules</b>	<b>No.</b>	<b>Rule description</b>	<b>Error code</b>	<b>Error message</b>	<b>Attribute</b>
	1.	The order status must be Completed.	2010	Invalid report order status.	orderId

	2.	According to the submitted order number: [orderId], the order does not exist.	2016	Report order doesn't exist in the system.	orderId
	3.	Invalid method selected or parameter specified incorrectly. According to the submitted order number: [orderId] report type is: [orderType]	2017	Invalid method selected for report data or incorrect parameter.	orderId orderType
	4.	No data found based on the search parameters submitted in the POST method.	2018	There is no data for the selected search parameters, the response is empty.	orderId

#### 7.12.4.1 JSON Request structure

The table below describes the structure of the JSON request:

Attribute	type	obligation	description

#### 7.12.4.2 JSON Response structure

The table below describes the structure of the JSON response:

Attribute	type	obligation	description
consumerCode	String(20)	required	Consumer code.
personName	String(200)	required	Person name / company name.
personSurname	String(50)	required	Person surname.
objectId	Integer	required	Object ID.
objectNumber	String(20)	required	Object number.
categories:[]			
consumptionCategory	String(20)	required	Consumption category. Possible meanings:

			<ul style="list-style-type: none"> <li>• P+;</li> <li>• P-;</li> <li>• Q+;</li> <li>• Q-.</li> </ul>
consumptions:[]			
consumptionTime	Datetime	required	Consumption time. Example of consumptionTime format: 2022-06-07T00:00:00+02:00 2022-06-07T00:00:00+03:00
amount	Double	required	Consumption amount.

#### 7.12.4.3 Error Response Structure

The following table describes the JSON structure in the event of a response error:

No.	Attribute	type	obligation	description
1.	code	number	required	Error code.
2.	text	string(4000)	required	Error message.

#### 7.12.5 GET/gateway/order/{orderId}/data-hr-15min-mtr-lvl

<b>URI</b>	GET/gateway/order/{orderId}/data-hr-15min-mtr-lvl
<b>Description</b>	The method is designed to obtain fifteen minute / hour report data.
<b>Parameters</b>	URL parameters:  <b>orderId</b> – order identification number <b>first</b> - the index of the object, which must be the first in the return list (starting from 0). Optional. The default value is 0.

	<b>count</b> - the number of objects in the return list. Optional. <a href="#">The default value is 10000. If no count value is given, the default value count will be 10000.</a>		
<b>Header</b>	After decrypting the supplier authentication key, the supplier ID is used to select the data.		
<b>JSON request</b>	GET request does not have the BODY part.		
<b>Response</b>	<b>HTTP status code</b>	<b>Reason</b>	<b>Response description</b>
	200	OK	Request completed successfully
	204	No content	No data found according to the given parameters.
	400	Bad Request	Request error. The HTTP response body provides a list of errors in JSON format.
	401	Unauthorized	An attempt was made to connect to a non-public method that requires authentication, but no user credentials were provided.
	403	Forbidden	According to the access control policy, the current user does not have access to perform the requested action.
	404	Not Found	Either there is no API method associated with the request URL path, or the request contains one or more parameters that did not return the data.
<b>JSON Response</b>	<pre>[   {     "personCode":"string",     "personName":"string",     "personSurname":"string",     "objectId":"number",     "objectNumber":"string",     "meters":[       {         "meterNumber":"string",         "categories":[           {             "consumptionCategory":"string",</pre>		

	<pre> "consumptions":[   {     "consumptionTime":"datetime",     "amount":"double"   } ] </pre>				
<b>JSON error response</b>	<pre> {   "errorMessages": [     {       "code": 0,       "text": "string"     }   ] } </pre>				
<b>Rules</b>	<b>No.</b>	<b>Rule description</b>	<b>Error code</b>	<b>Error message</b>	<b>Attribute</b>
	1.	The order status must be Completed.	2010	Invalid report order status.	orderId
	2.	According to the submitted order number: [orderId], the order does not exist.	2016	Report order doesn't exist in the system.	orderId
	3.	Invalid method selected or parameter specified incorrectly. According to the submitted order number: [orderId] report type is: [orderType]	2017	Invalid method selected for report data or incorrect parameter.	orderId orderType
	4.	No data found based on the search parameters submitted in the POST method.	2018	There is no data for the selected search parameters, the response is empty.	orderId

### 7.12.5.1 JSON Request structure

The table below describes the structure of the JSON request:

Attribute	type	obligation	description

### 7.12.5.2 JSON Response structure

The table below describes the structure of the JSON response:

Attribute	type	obligation	description
consumerCode	String(20)	required	Consumer code.
personName	String(200)	required	Person name / company name.
personSurname	String(50)	required	Person surname.
objectId	Integer	required	Object ID.
objectNumber	String(20)	required	Object number.
meters:[]			
meterNumber	String(20)	required	Meter number of the object.
categories:[]			
consumptionCategory	String(20)	required	Consumption category. Possible meanings: <ul style="list-style-type: none"> <li>• P+;</li> <li>• P-;</li> <li>• Q+;</li> <li>• Q-.</li> </ul>
Consumptions:[]			
consumptionTime	Datetime	required	Consumption time. Example of consumptionTime format: 2022-06-07T00:00:00+02:00 2022-06-07T00:00:00+03:00
amount	Double	required	Consumption amount.

### 7.12.5.3 Error Response Structure

The following table describes the JSON structure in the event of a response error:

No.	Attribute	type	obligation	description
1.	code	number	required	Error code.
2.	text	string(4000)	required	Error message.

### 7.12.6 GET/gateway/order/{orderId}/bill-2s2s-b2b

<b>URI</b>	GET/gateway/order/{orderId}/bill-2s2s-b2b		
<b>Description</b>	The method is used to obtain 2s2s report data.		
<b>Parameters</b>	URL parameters:  <b>orderId</b> – order identification number; <b>first</b> - the index of the invoice, which must be the first in the return list (starting from 0). Optional. The default value is 0. <b>count</b> - the number of invoices in the return list. Optional. <a href="#">The default value is 10000. If no count value is given, the default value count will be 10000.</a>		
<b>Header</b>	After decrypting the supplier authentication key, the supplier ID is used to select the data.		
<b>JSON request</b>	GET request does not have the BODY part.		
<b>Response</b>	<b>HTTP status code</b>	<b>Reason</b>	<b>Response description</b>
	200	OK	Request completed successfully
	204	No content	No data found according to the given parameters.
	400	Bad Request	Request error. The HTTP response body provides a list of errors in JSON format.



	401	Unauthorized	An attempt was made to connect to a non-public method that requires authentication, but no user credentials were provided.
	403	Forbidden	According to the access control policy, the current user does not have access to perform the requested action.
	404	Not Found	Either there is no API method associated with the request URL path, or the request contains one or more parameters that did not return the data.

<b>JSON Response</b>	<pre>[   {     "vatInvoiceNumber":"string",     "vatInvoiceSeries":"string",     "objects":[       {         "contractType":"string",         "consumerCode":"string",         "personCode":"string",         "personName":"string",         "personSurname":"string",         "objectId":"number",         "objectNumber":"string",         "objectName":"string",         "objectType":"string",         "objectAddress":"string",         "autoMetersAmount":"number",         "products":[           {             "billingPeriod":"datetime",             "permissiblePowerConsumption":"double",             "permissiblePowerGeneration":"double",             "generatingObjectType":"string",             "tariffPlan":"string",             "productCode":"string",             "productName":"string",             "productType":"string",</pre>		
----------------------	---	--	--

	<pre> "consumptionCategory":"string", "consumptionAmount":"double", "unit":"string", "oldIndependentSupplier":"string", "productConsumptionType":"string" } ] } ] } ] </pre>				
<b>JSON error response</b>	<pre> {   "errorMessages": [     {       "code": 0,       "text": "string"     }   ] } </pre>				
<b>Rules</b>	<b>No.</b>	<b>Rule description</b>	<b>Error code</b>	<b>Error message</b>	<b>Attribute</b>
	1.	The order status must be Completed.	2010	Invalid report order status.	orderId
	2.	According to the submitted order number: [orderId], the order does not exist.	2016	Report order doesn't exist in the system.	orderId
	3.	Invalid method selected or parameter specified incorrectly. According to the submitted order number: [orderId] report type is: [orderType]	2017	Invalid method selected for report data or incorrect parameter.	orderId orderType
	4.	No data found based on the search parameters submitted in the POST method.	2018	There is no data for the selected search parameters, the response is empty.	orderId

### 7.12.6.1 JSON Response structure

The table below describes the structure of the JSON response:

Attribute	type	obligation	description
contractType	String(10)	required	Contract type. There are 2 possible values:  SKMS SBTS
vatInvoiceNumber	String(25)	required	VAT invoice number.
vatInvoiceSeries	String(10)	required	VAT invoice series.
billingPeriod	datetime	required	Month in which electricity consumption is recorded.
consumerCode	String(20)	required	Consumer code.
generatingObjectType	String(5)	required	Generating consumer type. Possible meanings:  G – GV (Generating consumer); N – NGV (Distant generating consumer).
personCode	String(20)	required	Contract owner / tenant person / company code.
name	String(200)	required	Contract owner / tenant name / company name.
surname	String(50)	Not required	Contract owner / tenant surname.
objectId	Number	required	Object Id.
objectNumber	String(20)	required	Object number.
objectName	String(200)	required	Object name.
objectType	String(200)	required	Object type.
objectAddress	String(4000)	required	Object address.
permissiblePowerConsumption	Double(10,3)	required	Permissible power consumption in the object, kW.
permissiblePowerGeneration	Double(10,3)	required	Permissible power generation in the object, kW.

autoMetersAmount	Number	required	Total number of remotely readable or smart metering devices installed at the object.
oldIndependentSupplier	String(200)	required	Previous supplier of the object.
tariffPlan	String(250)	required	The tariff plan of object.
productCode	String(20)	required	The code of product.
productName	String(4000)	required	The product name.
productType	String(5)	required	Product type.
consumptionCategory	String(2)	required	Category of the consumption energy
consumptionAmount	Number	required	The amount of the consumption
unit	String(255)	required	The unit of the product.
productConsumptionType	String(20)	not required	Type of the product consumption. Possible meanings: <ul style="list-style-type: none"> <li>- AMS - Abonentinis mok. (Subscription fee)</li> <li>- FGS - Sutartiniai fiksuotos galios suvartojimo parametrai (Contractual fixed power consumption parameters)</li> <li>- GGS - Generuojamos galios (Generated power)</li> <li>- LGS - Leistinosios galios (Permissible power)</li> <li>- REPS - Sutartiniai reaktyviosios EE parametrai (Contractual reactive electricity parameters)</li> <li>- SPA - Pagal aktą (According to the act)</li> <li>- SPR - Pagal rodmenis (According to readings)</li> <li>- STA - Pagal taisykles (According to rules)</li> <li>- TSPS - Sutartiniai technologinių sąnaudų parametrai (Contractual technological cost parameters)</li> <li>- VAP - VIAP apskaitos parametrai (VIAP accounting parameters)</li> <li>- SPP - Pagal parametrus (According to parameters)</li> </ul>

### 7.12.6.2 Error Response Structure

The following table describes the JSON structure in the event of a response error:

No.	Attribute	type	obligation	description
1.	code	number	required	Error code.

No.	Attribute	type	obligation	description
2.	text	string(4000)	required	Error message.

### 7.12.7 GET/gateway/order/{orderId}/report-obj

<b>URI</b>	GET/gateway/order/{orderId}/report-obj		
<b>Description</b>	The method is used to obtain objects report data.		
<b>Parameters</b>	URL parameters:  <b>orderId</b> – order identification number; <b>first</b> - the index of the report line, which must be the first in the return list (starting from 0). Optional. The default value is 0. <b>count</b> - the number of report rows in the return list. Optional. <a href="#">The default value is 10000. If no count value is given, the default value count will be 10000.</a>		
<b>Header</b>	After decrypting the supplier authentication key, the supplier ID is used to select the data.		
<b>JSON request</b>	GET request does not have the BODY part.		
<b>Response</b>	<b>HTTP status code</b>	<b>Reason</b>	<b>Response description</b>
	200	OK	Request completed successfully
	204	No content	No data found according to the given parameters.
	400	Bad Request	Request error. The HTTP response body provides a list of errors in JSON format.
	401	Unauthorized	An attempt was made to connect to a non-public method that requires authentication, but no user credentials were provided.
	403	Forbidden	According to the access control policy, the current user does not have access to perform the requested action.

	404	Not Found	Either there is no API method associated with the request URL path, or the request contains one or more parameters that did not return the data.
<b>JSON Response</b>	<pre>[ { "consumerCode":"string", "personCode":"string", "personName":"string", "personSurname":"string", "objectId":"number", "objectNumber":"string", "objectName":"string", "objectType":"string", "objectAddress":"string", "contractType":"string", "contractModel":"string", "contractStart":"date", "contractEnd":"date", "permissiblePowerConsumption":"double", "permissiblePowerGeneration":"double", "metersAmount":"number", "autoMetersAmount":"number", "smartMeterInstallationDate":"date", "supplyState":"string", "supplyStateFrom":"date", "supplyStateTo":"date", "consumptionState":"string", "consumptionStateFrom":"date", "consumptionStateTo":"date", "productsAmount":"number", "scalesAmount":"number", "technologicalCosts":"boolean", "payoffMethod":"string", "generatingObjectType":"string", "generatingObjectTypeFrom":"date", "generatingObjectTypeTo":"date", "powerPlantType":"string", "voltage":"double", "tariffPlan":"string", "tariffPlanChangeDate":"date", "timeZone":"string" }</pre>		

	<pre> } ] </pre>				
<b>JSON error response</b>	<pre> {   "errorMessages": [     {       "code": 0,       "text": "string"     }   ] } </pre>				
<b>Rules</b>	<b>No.</b>	<b>Rule description</b>	<b>Error code</b>	<b>Error message</b>	<b>Attribute</b>
	1.	The order status must be Completed.	2010	Invalid report order status.	orderId
	2.	According to the submitted order number: [orderId], the order does not exist.	2016	Report order doesn't exist in the system.	orderId
	3.	Invalid method selected or parameter specified incorrectly. According to the submitted order number: [orderId] report type is: [orderType]	2017	Invalid method selected for report data or incorrect parameter.	orderId orderType
	4.	No data found based on the search parameters submitted in the POST method.	2018	There is no data for the selected search parameters, the response is empty.	orderId

#### 7.12.7.1 JSON Response structure

The table below describes the structure of the JSON response:

Attribute	type	obligation	description
-	-	-	Response description are provided in <a href="https://datahub.eso.lt/dokumentacija">https://datahub.eso.lt/dokumentacija</a> . In next document version, all fields description will be provided here.

#### 7.12.7.2 Error Response Structure

The following table describes the JSON structure in the event of a response error:

No.	Attribute	type	obligation	description
1.	code	number	required	Error code.
2.	text	string(4000)	required	Error message.

### 7.12.8 GET/gateway/order/{orderId}/bill-bss-b2c

<b>URI</b>	GET/gateway/order/{orderId}/bill-bss-b2c		
<b>Description</b>	The method is used to obtain b2c report data.		
<b>Parameters</b>	URL parameters: <b>orderId</b> – order identification number; <b>first</b> - the index of the report line, which must be the first in the return list (starting from 0). Optional. The default value is 0. <b>count</b> - the number of report rows in the return list. Optional. The default value is 30.		
<b>Header</b>	After decrypting the supplier authentication key, the supplier ID is used to select the data.		
<b>JSON request</b>	GET request does not have the BODY part.		
<b>Response</b>	<b>HTTP status code</b>	<b>Reason</b>	<b>Response description</b>
	200	OK	Request completed successfully
	204	No content	No data found according to the given parameters.
	400	Bad Request	Request error. The HTTP response body provides a list of errors in JSON format.
	401	Unauthorized	An attempt was made to connect to a non-public method that requires authentication, but no user credentials were provided.



	403	Forbidden	According to the access control policy, the current user does not have access to perform the requested action.
	404	Not Found	Either there is no API method associated with the request URL path, or the request contains one or more parameters that did not return the data.
<b>JSON Response</b>	<pre>[ { "CustomerID": "string", "ClientID": "string", "ClientName": "string", "ClientAddress": "string", "ObjectID": 0, "ObjectNumber": "string", "ObjectName": "string", "ObjectType": "string", "GeneratingCustomer": true, "ObjectAddress": "string", "AgreementType": "string", "AgreementModel": "string", "AgreementFrom": "2020-09-21", "AgreementTo": "2020-09-21", "PermittablePowerConsumption": 0, "PermittablePowerGeneration": 0, "InstalledGeneratingPower": 0, "InstalledConsumptionPower": 0, "MetersAmount": 0, "AutoMetersAmount": 0, "ReportingPeriod": "2020-09-21", "BillingPeriod": "2020-09-21", "SupplyState": "string", "SupplyStateFrom": "2020-09-21", "SupplyStateTo": "2020-09-21", "MetersNumber": "string", "ReadingsSource": "string", "ReadingsReceiveDate": "2020-09-21", "PaymentType": "string", "Service": "string", "DeclarationReferenceType": "string", "ReferenceSubmitDate": "2020-09-21", "ReadingsSubmitDate": "2020-09-21",</pre>		

"DeclarationReferenceNumber": 0,  
"UnaccountedConsumptionActNumber": 0,  
"UnaccountedConsumptionActCreateDate": "2020-09-21",  
"UnaccountedConsumptionActFrom": "2020-09-21",  
"UnaccountedConsumptionActTo": "2020-09-21",  
"ConsumptionConversionActNumber": "string",  
"ConsumptionConversionActCreateDate": "2020-09-21",  
"ConsumptionConversionActFrom": "2020-09-21",  
"ConsumptionConversionActTo": "2020-09-21",  
"ConsumptionState": "string",  
"ConsumptionStateFrom": "2020-09-21",  
"ConsumptionStateTo": "2020-09-21",  
"TariffPlan": "string",  
"TariffPlanChangeDate": "2020-09-21",  
"ConsumptionConversionAct": true,  
"PowerPlantCapacityDateFrom": "2020-09-21",  
"EnergyObtainedDateFrom": "2020-09-21",  
"PowerPlantCapacityDateTo": "2020-09-21",  
"EnergyObtainedDateTo": "2020-09-21",  
"EnergyObtainedPowerKw": 0,  
"OperatorGridElectricityPercent": 0,  
"ClientGridElectricityPercent": 0,  
"VkConsumptionAmount": 0,  
"VkViapConsumptionAmount": 0,  
"VkSppdConsumptionAmount": 0,  
"DdConsumptionAmount": 0,  
"DdViapConsumptionAmount": 0,  
"DdSppdConsumptionAmount": 0,  
"NkConsumptionAmount": 0,  
"NkViapConsumptionAmount": 0,  
"NkSppdConsumptionAmount": 0,  
"N2ConsumptionAmount": 0,  
"N2ViapConsumptionAmount": 0,  
"N2SppdConsumptionAmount": 0,  
"D1ConsumptionAmount": 0,  
"D1ViapConsumptionAmount": 0,  
"D1SppdConsumptionAmount": 0,  
"D2ConsumptionAmount": 0,  
"D2ViapConsumptionAmount": 0,  
"D2SppdConsumptionAmount": 0,  
"N1ConsumptionAmount": 0,  
"N1ViapConsumptionAmount": 0,

"N1SppdConsumptionAmount": 0,  
"VkConsumedElectricityConsumptionAmount": 0,  
"DdConsumedElectricityConsumptionAmount": 0,  
"NkConsumedElectricityConsumptionAmount": 0,  
"N2ConsumedElectricityConsumptionAmount": 0,  
"D1ConsumedElectricityConsumptionAmount": 0,  
"D2ConsumedElectricityConsumptionAmount": 0,  
"N1ConsumedElectricityConsumptionAmount": 0,  
"VkPayingRecoveredEnergyConsumptionAmount": 0,  
"DdPayingRecoveredEnergyConsumptionAmount": 0,  
"NkPayingRecoveredEnergyConsumptionAmount": 0,  
"N2PayingRecoveredEnergyConsumptionAmount": 0,  
"D1PayingRecoveredEnergyConsumptionAmount": 0,  
"D2PayingRecoveredEnergyConsumptionAmount": 0,  
"N1PayingRecoveredEnergyConsumptionAmount": 0,  
"VkPayingRecoveredPercentConsumptionAmount": 0,  
"DdPayingRecoveredPercentConsumptionAmount": 0,  
"NkPayingRecoveredPercentConsumptionAmount": 0,  
"N2PayingRecoveredPercentConsumptionAmount": 0,  
"D1PayingRecoveredPercentConsumptionAmount": 0,  
"D2PayingRecoveredPercentConsumptionAmount": 0,  
"N1PayingRecoveredPercentConsumptionAmount": 0,  
"VkPayingRecoveredPowerConsumptionAmount": 0,  
"DdPayingRecoveredPowerConsumptionAmount": 0,  
"NkPayingRecoveredPowerConsumptionAmount": 0,  
"N2PayingRecoveredPowerConsumptionAmount": 0,  
"D1PayingRecoveredPowerConsumptionAmount": 0,  
"D2PayingRecoveredPowerConsumptionAmount": 0,  
"N1PayingRecoveredPowerConsumptionAmount": 0,  
"VkPayingRecoveredMixedConsumptionAmount": 0,  
"DdPayingRecoveredMixedConsumptionAmount": 0,  
"NkPayingRecoveredMixedConsumptionAmount": 0,  
"N2PayingRecoveredMixedConsumptionAmount": 0,  
"D1PayingRecoveredMixedConsumptionAmount": 0,  
"D2PayingRecoveredMixedConsumptionAmount": 0,  
"N1PayingRecoveredMixedConsumptionAmount": 0,  
"VkMissingEnergyConsumptionAmount": 0,  
"VkMissingEnergyViapConsumptionAmount": 0,  
"VkMissingEnergySppdConsumptionAmount": 0,  
"DdMissingEnergyConsumptionAmount": 0,  
"DdMissingEnergyViapConsumptionAmount": 0,  
"DdMissingEnergySppdConsumptionAmount": 0,

"NkMissingEnergyConsumptionAmount": 0,  
"NkMissingEnergyViapConsumptionAmount": 0,  
"NkMissingEnergySppdConsumptionAmount": 0,  
"N2MissingEnergyConsumptionAmount": 0,  
"N2MissingEnergyViapConsumptionAmount": 0,  
"N2MissingEnergySppdConsumptionAmount": 0,  
"D1MissingEnergyConsumptionAmount": 0,  
"D1MissingEnergyViapConsumptionAmount": 0,  
"D1MissingEnergySppdConsumptionAmount": 0,  
"D2MissingEnergyConsumptionAmount": 0,  
"D2MissingEnergyViapConsumptionAmount": 0,  
"D2MissingEnergySppdConsumptionAmount": 0,  
"N1MissingEnergyConsumptionAmount": 0,  
"N1MissingEnergyViapConsumptionAmount": 0,  
"N1MissingEnergySppdConsumptionAmount": 0,  
"GridSuppliedConsumptionAmount": 0,  
"AccumulatedBeginningConsumptionAmount": 0,  
"AccumulatedEndConsumptionAmount": 0,  
"AccumulatedUploadedConsumptionAmount": 0,  
"AccumulatedRaisedConsumptionAmount": 0,  
"CompensatedConsumptionAmount": 0,  
"OldIndependentSupplier": "string",  
"PowerPlantCapacityConsumptionAmount": 0,  
"EnergyObtainedConsumptionAmount": 0,  
"OperatorGridElectricityConsumptionAmount": 0,  
"ClientGridElectricityConsumptionAmount": 0,  
"VkUnit": "string",  
"VkViapUnit": "string",  
"VkSppdUnit": "string",  
"DdUnit": "string",  
"DdViapUnit": "string",  
"DdSppdUnit": "string",  
"NkUnit": "string",  
"NkViapUnit": "string",  
"NkSppdUnit": "string",  
"N2Unit": "string",  
"N2ViapUnit": "string",  
"N2SppdUnit": "string",  
"D1Unit": "string",  
"D1ViapUnit": "string",  
"D1SppdUnit": "string",  
"D2Unit": "string",

"D2ViapUnit": "string",  
"D2SppdUnit": "string",  
"N1Unit": "string",  
"N1ViapUnit": "string",  
"N1SppdUnit": "string",  
"VkConsumedElectricityUnit": "string",  
"DdConsumedElectricityUnit": "string",  
"NkConsumedElectricityUnit": "string",  
"N2ConsumedElectricityUnit": "string",  
"D1ConsumedElectricityUnit": "string",  
"D2ConsumedElectricityUnit": "string",  
"N1ConsumedElectricityUnit": "string",  
"VkPayingRecoveredEnergyUnit": "string",  
"DdPayingRecoveredEnergyUnit": "string",  
"NkPayingRecoveredEnergyUnit": "string",  
"N2PayingRecoveredEnergyUnit": "string",  
"D1PayingRecoveredEnergyUnit": "string",  
"D2PayingRecoveredEnergyUnit": "string",  
"N1PayingRecoveredEnergyUnit": "string",  
"VkPayingRecoveredPercentUnit": "string",  
"DdPayingRecoveredPercentUnit": "string",  
"NkPayingRecoveredPercentUnit": "string",  
"N2PayingRecoveredPercentUnit": "string",  
"D1PayingRecoveredPercentUnit": "string",  
"D2PayingRecoveredPercentUnit": "string",  
"N1PayingRecoveredPercentUnit": "string",  
"VkPayingRecoveredPowerUnit": "string",  
"DdPayingRecoveredPowerUnit": "string",  
"NkPayingRecoveredPowerUnit": "string",  
"N2PayingRecoveredPowerUnit": "string",  
"D1PayingRecoveredPowerUnit": "string",  
"D2PayingRecoveredPowerUnit": "string",  
"N1PayingRecoveredPowerUnit": "string",  
"VkPayingRecoveredMixedUnit": "string",  
"DdPayingRecoveredMixedUnit": "string",  
"NkPayingRecoveredMixedUnit": "string",  
"N2PayingRecoveredMixedUnit": "string",  
"D1PayingRecoveredMixedUnit": "string",  
"D2PayingRecoveredMixedUnit": "string",  
"N1PayingRecoveredMixedUnit": "string",  
"VkMissingEnergyUnit": "string",  
"VkMissingEnergyViapUnit": "string",

"VkMissingEnergySppdUnit": "string",  
"DdMissingEnergyUnit": "string",  
"DdMissingEnergyViapUnit": "string",  
"DdMissingEnergySppdUnit": "string",  
"NkMissingEnergyUnit": "string",  
"NkMissingEnergyViapUnit": "string",  
"NkMissingEnergySppdUnit": "string",  
"N2MissingEnergyUnit": "string",  
"N2MissingEnergyViapUnit": "string",  
"N2MissingEnergySppdUnit": "string",  
"D1MissingEnergyUnit": "string",  
"D1MissingEnergyViapUnit": "string",  
"D1MissingEnergySppdUnit": "string",  
"D2MissingEnergyUnit": "string",  
"D2MissingEnergyViapUnit": "string",  
"D2MissingEnergySppdUnit": "string",  
"N1MissingEnergyUnit": "string",  
"N1MissingEnergyViapUnit": "string",  
"N1MissingEnergySppdUnit": "string",  
"VkReadingsFrom": 0,  
"DdReadingsFrom": 0,  
"NkReadingsFrom": 0,  
"N2ReadingsFrom": 0,  
"D1ReadingsFrom": 0,  
"D2ReadingsFrom": 0,  
"N1ReadingsFrom": 0,  
"VkConsumedElectricityReadingsFrom": 0,  
"DdConsumedElectricityReadingsFrom": 0,  
"NkConsumedElectricityReadingsFrom": 0,  
"N2ConsumedElectricityReadingsFrom": 0,  
"D1ConsumedElectricityReadingsFrom": 0,  
"D2ConsumedElectricityReadingsFrom": 0,  
"N1ConsumedElectricityReadingsFrom": 0,  
"GridSuppliedReadingsFrom": 0,  
"VkReadingsTo": 0,  
"DdReadingsTo": 0,  
"NkReadingsTo": 0,  
"N2ReadingsTo": 0,  
"D1ReadingsTo": 0,  
"D2ReadingsTo": 0,  
"N1ReadingsTo": 0,  
"VkConsumedElectricityReadingsTo": 0,

"DdConsumedElectricityReadingsTo": 0,  
"NkConsumedElectricityReadingsTo": 0,  
"N2ConsumedElectricityReadingsTo": 0,  
"D1ConsumedElectricityReadingsTo": 0,  
"D2ConsumedElectricityReadingsTo": 0,  
"N1ConsumedElectricityReadingsTo": 0,  
"GridSuppliedReadingsTo": 0,  
"VkPriceEur": 0,  
"VkViapPriceEur": 0,  
"VkSppdPriceEur": 0,  
"DdPriceEur": 0,  
"DdViapPriceEur": 0,  
"DdSppdPriceEur": 0,  
"NkPriceEur": 0,  
"NkViapPriceEur": 0,  
"NkSppdPriceEur": 0,  
"N2PriceEur": 0,  
"N2ViapPriceEur": 0,  
"N2SppdPriceEur": 0,  
"D1PriceEur": 0,  
"D1ViapPriceEur": 0,  
"D1SppdPriceEur": 0,  
"D2PriceEur": 0,  
"D2ViapPriceEur": 0,  
"D2SppdPriceEur": 0,  
"N1PriceEur": 0,  
"N1ViapPriceEur": 0,  
"N1SppdPriceEur": 0,  
"VkPayingRecoveredEnergyPriceEur": 0,  
"DdPayingRecoveredEnergyPriceEur": 0,  
"NkPayingRecoveredEnergyPriceEur": 0,  
"N2PayingRecoveredEnergyPriceEur": 0,  
"D1PayingRecoveredEnergyPriceEur": 0,  
"D2PayingRecoveredEnergyPriceEur": 0,  
"N1PayingRecoveredEnergyPriceEur": 0,  
"VkPayingRecoveredMixedPriceEur": 0,  
"DdPayingRecoveredMixedPriceEur": 0,  
"NkPayingRecoveredMixedPriceEur": 0,  
"N2PayingRecoveredMixedPriceEur": 0,  
"D1PayingRecoveredMixedPriceEur": 0,  
"D2PayingRecoveredMixedPriceEur": 0,  
"N1PayingRecoveredMixedPriceEur": 0,

"VkMissingEnergyPriceEur": 0,  
"VkMissingEnergyViapPriceEur": 0,  
"VkMissingEnergySppdPriceEur": 0,  
"DdMissingEnergyPriceEur": 0,  
"DdMissingEnergyViapPriceEur": 0,  
"DdMissingEnergySppdPriceEur": 0,  
"NkMissingEnergyPriceEur": 0,  
"NkMissingEnergyViapPriceEur": 0,  
"NkMissingEnergySppdPriceEur": 0,  
"N2MissingEnergyPriceEur": 0,  
"N2MissingEnergyViapPriceEur": 0,  
"N2MissingEnergySppdPriceEur": 0,  
"D1MissingEnergyPriceEur": 0,  
"D1MissingEnergyViapPriceEur": 0,  
"D1MissingEnergySppdPriceEur": 0,  
"D2MissingEnergyPriceEur": 0,  
"D2MissingEnergyViapPriceEur": 0,  
"D2MissingEnergySppdPriceEur": 0,  
"N1MissingEnergyPriceEur": 0,  
"N1MissingEnergyViapPriceEur": 0,  
"N1MissingEnergySppdPriceEur": 0,  
"PowerPlantCapacityPriceEur": 0,  
"VkPriceEurVAT": 0,  
"VkViapPriceEurVAT": 0,  
"VkSppdPriceEurVAT": 0,  
"DdPriceEurVAT": 0,  
"DdViapPriceEurVAT": 0,  
"DdSppdPriceEurVAT": 0,  
"NkPriceEurVAT": 0,  
"NkViapPriceEurVAT": 0,  
"NkSppdPriceEurVAT": 0,  
"N2PriceEurVAT": 0,  
"N2ViapPriceEurVAT": 0,  
"N2SppdPriceEurVAT": 0,  
"D1PriceEurVAT": 0,  
"D1ViapPriceEurVAT": 0,  
"D1SppdPriceEurVAT": 0,  
"D2PriceEurVAT": 0,  
"D2ViapPriceEurVAT": 0,  
"D2SppdPriceEurVAT": 0,  
"N1PriceEurVAT": 0,  
"N1ViapPriceEurVAT": 0,



"N1SppdPriceEurVAT": 0,  
"VkPayingRecoveredEnergyPriceEurVAT": 0,  
"DdPayingRecoveredEnergyPriceEurVAT": 0,  
"NkPayingRecoveredEnergyPriceEurVAT": 0,  
"N2PayingRecoveredEnergyPriceEurVAT": 0,  
"D1PayingRecoveredEnergyPriceEurVAT": 0,  
"D2PayingRecoveredEnergyPriceEurVAT": 0,  
"N1PayingRecoveredEnergyPriceEurVAT": 0,  
"VkPayingRecoveredMixedPriceEurVAT": 0,  
"DdPayingRecoveredMixedPriceEurVAT": 0,  
"NkPayingRecoveredMixedPriceEurVAT": 0,  
"N2PayingRecoveredMixedPriceEurVAT": 0,  
"D1PayingRecoveredMixedPriceEurVAT": 0,  
"D2PayingRecoveredMixedPriceEurVAT": 0,  
"N1PayingRecoveredMixedPriceEurVAT": 0,  
"VkMissingEnergyPriceEurVAT": 0,  
"VkMissingEnergyViapPriceEurVAT": 0,  
"VkMissingEnergySppdPriceEurVAT": 0,  
"DdMissingEnergyPriceEurVAT": 0,  
"DdMissingEnergyViapPriceEurVAT": 0,  
"DdMissingEnergySppdPriceEurVAT": 0,  
"NkMissingEnergyPriceEurVAT": 0,  
"NkMissingEnergyViapPriceEurVAT": 0,  
"NkMissingEnergySppdPriceEurVAT": 0,  
"N2MissingEnergyPriceEurVAT": 0,  
"N2MissingEnergyViapPriceEurVAT": 0,  
"N2MissingEnergySppdPriceEurVAT": 0,  
"D1MissingEnergyPriceEurVAT": 0,  
"D1MissingEnergyViapPriceEurVAT": 0,  
"D1MissingEnergySppdPriceEurVAT": 0,  
"D2MissingEnergyPriceEurVAT": 0,  
"D2MissingEnergyViapPriceEurVAT": 0,  
"D2MissingEnergySppdPriceEurVAT": 0,  
"N1MissingEnergyPriceEurVAT": 0,  
"N1MissingEnergyViapPriceEurVAT": 0,  
"N1MissingEnergySppdPriceEurVAT": 0,  
"PowerPlantCapacityPriceEurVAT": 0,  
"VkDiscount": 0,  
"VkViapDiscount": 0,  
"VkSppdDiscount": 0,  
"DdDiscount": 0,  
"DdViapDiscount": 0,

"DdSppdDiscount": 0,  
"NkDiscount": 0,  
"NkViapDiscount": 0,  
"NkSppdDiscount": 0,  
"N2Discount": 0,  
"N2ViapDiscount": 0,  
"N2SppdDiscount": 0,  
"D1Discount": 0,  
"D1ViapDiscount": 0,  
"D1SppdDiscount": 0,  
"D2Discount": 0,  
"D2ViapDiscount": 0,  
"D2SppdDiscount": 0,  
"N1Discount": 0,  
"N1ViapDiscount": 0,  
"N1SppdDiscount": 0,  
"VkPayingRecoveredEnergyDiscount": 0,  
"VkPayingRecoveredMixedDiscount": 0,  
"VkMissingEnergyDiscount": 0,  
"VkMissingEnergyViapDiscount": 0,  
"VkMissingEnergySppdDiscount": 0,  
"FixedFeeAmountNoVAT": 0,  
"VkAmountNoVAT": 0,  
"VkViapAmountNoVAT": 0,  
"VkSppdAmountNoVAT": 0,  
"DdAmountNoVAT": 0,  
"DdViapAmountNoVAT": 0,  
"DdSppdAmountNoVAT": 0,  
"NkAmountNoVAT": 0,  
"NkViapAmountNoVAT": 0,  
"NkSppdAmountNoVAT": 0,  
"N2AmountNoVAT": 0,  
"N2ViapAmountNoVAT": 0,  
"N2SppdAmountNoVAT": 0,  
"D1AmountNoVAT": 0,  
"D1ViapAmountNoVAT": 0,  
"D1SppdAmountNoVAT": 0,  
"D2AmountNoVAT": 0,  
"D2ViapAmountNoVAT": 0,  
"D2SppdAmountNoVAT": 0,  
"N1AmountNoVAT": 0,  
"N1ViapAmountNoVAT": 0,

"N1SppdAmountNoVAT": 0,  
"VkPayingRecoveredEnergyAmountNoVAT": 0,  
"DdPayingRecoveredEnergyAmountNoVAT": 0,  
"NkPayingRecoveredEnergyAmountNoVAT": 0,  
"N2PayingRecoveredEnergyAmountNoVAT": 0,  
"D1PayingRecoveredEnergyAmountNoVAT": 0,  
"D2PayingRecoveredEnergyAmountNoVAT": 0,  
"N1PayingRecoveredEnergyAmountNoVAT": 0,  
"VkPayingRecoveredMixedAmountNoVAT": 0,  
"DdPayingRecoveredMixedAmountNoVAT": 0,  
"NkPayingRecoveredMixedAmountNoVAT": 0,  
"N2PayingRecoveredMixedAmountNoVAT": 0,  
"D1PayingRecoveredMixedAmountNoVAT": 0,  
"D2PayingRecoveredMixedAmountNoVAT": 0,  
"N1PayingRecoveredMixedAmountNoVAT": 0,  
"VkMissingEnergyAmountNoVAT": 0,  
"VkMissingEnergyViapAmountNoVAT": 0,  
"VkMissingEnergySppdAmountNoVAT": 0,  
"DdMissingEnergyAmountNoVAT": 0,  
"DdMissingEnergyViapAmountNoVAT": 0,  
"DdMissingEnergySppdAmountNoVAT": 0,  
"NkMissingEnergyAmountNoVAT": 0,  
"NkMissingEnergyViapAmountNoVAT": 0,  
"NkMissingEnergySppdAmountNoVAT": 0,  
"N2MissingEnergyAmountNoVAT": 0,  
"N2MissingEnergyViapAmountNoVAT": 0,  
"N2MissingEnergySppdAmountNoVAT": 0,  
"D1MissingEnergyAmountNoVAT": 0,  
"D1MissingEnergyViapAmountNoVAT": 0,  
"D1MissingEnergySppdAmountNoVAT": 0,  
"D2MissingEnergyAmountNoVAT": 0,  
"D2MissingEnergyViapAmountNoVAT": 0,  
"D2MissingEnergySppdAmountNoVAT": 0,  
"N1MissingEnergyAmountNoVAT": 0,  
"N1MissingEnergyViapAmountNoVAT": 0,  
"N1MissingEnergySppdAmountNoVAT": 0,  
"PowerPlantCapacityAmountNoVAT": 0,  
"FixedFeeAmount": 0,  
"VkAmount": 0,  
"VkViapAmount": 0,  
"VkSppdAmount": 0,  
"DdAmount": 0,

"DdViapAmount": 0,  
"DdSppdAmount": 0,  
"NkAmount": 0,  
"NkViapAmount": 0,  
"NkSppdAmount": 0,  
"N2Amount": 0,  
"N2ViapAmount": 0,  
"N2SppdAmount": 0,  
"D1Amount": 0,  
"D1ViapAmount": 0,  
"D1SppdAmount": 0,  
"D2Amount": 0,  
"D2ViapAmount": 0,  
"D2SppdAmount": 0,  
"N1Amount": 0,  
"N1ViapAmount": 0,  
"N1SppdAmount": 0,  
"VkPayingRecoveredEnergyAmount": 0,  
"DdPayingRecoveredEnergyAmount": 0,  
"NkPayingRecoveredEnergyAmount": 0,  
"N2PayingRecoveredEnergyAmount": 0,  
"D1PayingRecoveredEnergyAmount": 0,  
"D2PayingRecoveredEnergyAmount": 0,  
"N1PayingRecoveredEnergyAmount": 0,  
"VkPayingRecoveredMixedAmount": 0,  
"DdPayingRecoveredMixedAmount": 0,  
"NkPayingRecoveredMixedAmount": 0,  
"N2PayingRecoveredMixedAmount": 0,  
"D1PayingRecoveredMixedAmount": 0,  
"D2PayingRecoveredMixedAmount": 0,  
"N1PayingRecoveredMixedAmount": 0,  
"VkMissingEnergyAmount": 0,  
"VkMissingEnergyViapAmount": 0,  
"VkMissingEnergySppdAmount": 0,  
"DdMissingEnergyAmount": 0,  
"DdMissingEnergyViapAmount": 0,  
"DdMissingEnergySppdAmount": 0,  
"NkMissingEnergyAmount": 0,  
"NkMissingEnergyViapAmount": 0,  
"NkMissingEnergySppdAmount": 0,  
"N2MissingEnergyAmount": 0,  
"N2MissingEnergyViapAmount": 0,

"N2MissingEnergySppdAmount": 0,  
"D1MissingEnergyAmount": 0,  
"D1MissingEnergyViapAmount": 0,  
"D1MissingEnergySppdAmount": 0,  
"D2MissingEnergyAmount": 0,  
"D2MissingEnergyViapAmount": 0,  
"D2MissingEnergySppdAmount": 0,  
"N1MissingEnergyAmount": 0,  
"N1MissingEnergyViapAmount": 0,  
"N1MissingEnergySppdAmount": 0,  
"PowerPlantCapacityAmount": 0,  
"FixedFeeIncludedVAT": "string",  
"VkIncludedVAT": "string",  
"VkViapIncludedVAT": "string",  
"VkSppdIncludedVAT": "string",  
"DdIncludedVAT": "string",  
"DdViapIncludedVAT": "string",  
"DdSppdIncludedVAT": "string",  
"NkIncludedVAT": "string",  
"NkViapIncludedVAT": "string",  
"NkSppdIncludedVAT": "string",  
"N2IncludedVAT": "string",  
"N2ViapIncludedVAT": "string",  
"N2SppdIncludedVAT": "string",  
"D1IncludedVAT": "string",  
"D1ViapIncludedVAT": "string",  
"D1SppdIncludedVAT": "string",  
"D2IncludedVAT": "string",  
"D2ViapIncludedVAT": "string",  
"D2SppdIncludedVAT": "string",  
"N1IncludedVAT": "string",  
"N1ViapIncludedVAT": "string",  
"N1SppdIncludedVAT": "string",  
"VkPayingRecoveredEnergyIncludedVAT": "string",  
"DdPayingRecoveredEnergyIncludedVAT": "string",  
"NkPayingRecoveredEnergyIncludedVAT": "string",  
"N2PayingRecoveredEnergyIncludedVAT": "string",  
"D1PayingRecoveredEnergyIncludedVAT": "string",  
"D2PayingRecoveredEnergyIncludedVAT": "string",  
"N1PayingRecoveredEnergyIncludedVAT": "string",  
"VkPayingRecoveredMixedIncludedVAT": "string",  
"DdPayingRecoveredMixedIncludedVAT": "string",

	<pre> "NkPayingRecoveredMixedIncludedVAT": "string", "N2PayingRecoveredMixedIncludedVAT": "string", "D1PayingRecoveredMixedIncludedVAT": "string", "D2PayingRecoveredMixedIncludedVAT": "string", "N1PayingRecoveredMixedIncludedVAT": "string", "VkMissingEnergyIncludedVAT": "string", "VkMissingEnergyViapIncludedVAT": "string", "VkMissingEnergySppdIncludedVAT": "string", "DdMissingEnergyIncludedVAT": "string", "DdMissingEnergyViapIncludedVAT": "string", "DdMissingEnergySppdIncludedVAT": "string", "NkMissingEnergyIncludedVAT": "string", "NkMissingEnergyViapIncludedVAT": "string", "NkMissingEnergySppdIncludedVAT": "string", "N2MissingEnergyIncludedVAT": "string", "N2MissingEnergyViapIncludedVAT": "string", "N2MissingEnergySppdIncludedVAT": "string", "D1MissingEnergyIncludedVAT": "string", "D1MissingEnergyViapIncludedVAT": "string", "D1MissingEnergySppdIncludedVAT": "string", "D2MissingEnergyIncludedVAT": "string", "D2MissingEnergyViapIncludedVAT": "string", "D2MissingEnergySppdIncludedVAT": "string", "N1MissingEnergyIncludedVAT": "string", "N1MissingEnergyViapIncludedVAT": "string", "N1MissingEnergySppdIncludedVAT": "string", "PowerPlantCapacityIncludedVAT": "string", "PowerPlantCapacityUnit": "string" } ] </pre>				
<b>JSON error response</b>	<pre> {   "errorMessages": [     {       "code": 0,       "text": "string"     }   ] } </pre>				
<b>Rules</b>	<b>No.</b>	<b>Rule description</b>	<b>Error code</b>	<b>Error message</b>	<b>Attribute</b>

	1.	The order status must be Completed.	2010	Invalid report order status.	orderId
	2.	According to the submitted order number: [orderId], the order does not exist.	2016	Report order doesn't exist in the system.	orderId
	3.	Invalid method selected or parameter specified incorrectly. According to the submitted order number: [orderId] report type is: [orderType]	2017	Invalid method selected for report data or incorrect parameter.	orderId orderType
	4.	No data found based on the search parameters submitted in the POST method.	2018	There is no data for the selected search parameters, the response is empty.	orderId

### 7.12.8.1 JSON Response structure

The table below describes the structure of the JSON response:

Attribute	type	obligation	description
-	-	-	Response description are provided in <a href="#">additional documentation</a> . In next document version, all fields description will be provided here.

### 7.12.8.2 Error Response Structure

The following table describes the JSON structure in the event of a response error:

No.	Attribute	type	obligation	description
1.	code	number	required	Error code.
2.	text	string(4000)	required	Error message.

### 7.12.9 GET/gateway/order/{orderId}/bill-bss-b2b

<b>URI</b>	GET/gateway/order/{orderId}/bill-bss-b2b
------------	--

<b>Description</b>	The method is used to obtain b2b report data.		
<b>Parameters</b>	URL parameters:  <b>orderId</b> – order identification number; <b>first</b> - the index of the report line, which must be the first in the return list (starting from 0). Optional. The default value is 0. <b>count</b> - the number of report rows in the return list. Optional. The default value is 30.		
<b>Header</b>	After decrypting the supplier authentication key, the supplier ID is used to select the data.		
<b>JSON request</b>	GET request does not have the BODY part.		
<b>Response</b>	<b>HTTP status code</b>	<b>Reason</b>	<b>Response description</b>
	200	OK	Request completed successfully
	204	No content	No data found according to the given parameters.
	400	Bad Request	Request error. The HTTP response body provides a list of errors in JSON format.
	401	Unauthorized	An attempt was made to connect to a non-public method that requires authentication, but no user credentials were provided.
	403	Forbidden	According to the access control policy, the current user does not have access to perform the requested action.
	404	Not Found	Either there is no API method associated with the request URL path, or the request contains one or more parameters that did not return the data.
<b>JSON Response</b>	<pre>[   {     "CustomerID": 0,     "ClientID": "string",     "ClientName": "string",     "ClientAddress": "string",     "ObjectID": 0,     "ObjectNumber": "string",</pre>		



"ObjectName": "string",  
"ObjectType": "string",  
"GeneratingCustomer": true,  
"ObjectAddress": "string",  
"AgreementType": "string",  
"AgreementModel": "string",  
"AgreementFrom": 0,  
"AgreementTo": 0,  
"PermittablePowerConsumption": 0,  
"PermittablePowerGeneration": 0,  
"InstalledGeneratingPower": 0,  
"InstalledConsumptionPower": 0,  
"MetersAmount": 0,  
"AutoMetersAmount": 0,  
"ReportingPeriod": "2020-09-02",  
"BillingPeriod": "2020-09-02",  
"SupplyState": "string",  
"SupplyStateFrom": "2020-09-02",  
"SupplyStateTo": "2020-09-02",  
"MetersNumber": "string",  
"ReadingsSource": "string",  
"ReadingsReceiveDate": "2020-09-02",  
"PaymentType": "string",  
"DeclarationReferenceType": "string",  
"Service": "string",  
"ReferenceSubmitDate": "2020-09-02",  
"ReadingsSubmitDate": "2020-09-02",  
"DeclarationReferenceNumber": 0,  
"UnaccountedConsumptionActNumber": 0,  
"UnaccountedConsumptionActCreateDate": "2020-09-02",  
"UnaccountedConsumptionActFrom": "2020-09-02",  
"UnaccountedConsumptionActTo": "2020-09-02",  
"ConsumptionConversionActNumber": "string",  
"ConsumptionConversionActCreateDate": "2020-09-02",  
"ConsumptionConversionActFrom": "2020-09-02",  
"ConsumptionConversionActTo": "2020-09-02",  
"ConsumptionState": "string",  
"ConsumptionStateFrom": "2020-09-02",  
"ConsumptionStateTo": "2020-09-02",  
"TariffPlan": "string",  
"PowerPlantCapacityDateFrom": "2020-09-02",  
"EnergyObtainedDateFrom": "2020-09-02",

"PowerPlantCapacityDateTo": "2020-09-02",  
"PowerPlantCapacitySource": "string",  
"PowerPlantCapacitySourceDateFrom": "2020-09-02",  
"PowerPlantCapacitySourceDateTo": "2020-09-02",  
"EnergyObtainedDateTo": "2020-09-02",  
"EnergyObtainedPowerKw": 0,  
"TariffPlanChangeDate": "2020-09-02",  
"ConsumptionConversionAct": true,  
"UnaccountedAct": true,  
"ConversionAct": true,  
"OperatorGridElectricityPercent": 0,  
"ClientGridElectricityPercent": 0,  
"GaConsumptionAmount": 0,  
"VkConsumptionAmount": 0,  
"VkViapConsumptionAmount": 0,  
"VkSppdConsumptionAmount": 0,  
"VkDiscountConsumptionAmount": 0,  
"DdConsumptionAmount": 0,  
"DdViapConsumptionAmount": 0,  
"DdSppdConsumptionAmount": 0,  
"DdDiscountConsumptionAmount": 0,  
"NkConsumptionAmount": 0,  
"NkViapConsumptionAmount": 0,  
"NkSppdConsumptionAmount": 0,  
"NkDiscountConsumptionAmount": 0,  
"MaConsumptionAmount": 0,  
"MaViapConsumptionAmount": 0,  
"VdConsumptionAmount": 0,  
"VdViapConsumptionAmount": 0,  
"SvConsumptionAmount": 0,  
"SvViapConsumptionAmount": 0,  
"MiConsumptionAmount": 0,  
"MiViapConsumptionAmount": 0,  
"RvConsumptionAmount": 0,  
"RgConsumptionAmount": 0,  
"VgConsumptionAmount": 0,  
"Reliability1ConsumptionAmount": 0,  
"Reliability2ConsumptionAmount": 0,  
"Reliability3ConsumptionAmount": 0,  
"TechnologicalCostsViapConsumptionAmount": 0,  
"TechnologicalCostsConsumptionAmount": 0,  
"GeneralInterestConsumptionAmount": 0,

"VkConsumedElectricityConsumptionAmount": 0,  
"DdConsumedElectricityConsumptionAmount": 0,  
"NkConsumedElectricityConsumptionAmount": 0,  
"MaConsumedElectricityConsumptionAmount": 0,  
"VdConsumedElectricityConsumptionAmount": 0,  
"SvConsumedElectricityConsumptionAmount": 0,  
"MiConsumedElectricityConsumptionAmount": 0,  
"VkPayingRecoveredEnergyConsumptionAmount": 0,  
"DdPayingRecoveredEnergyConsumptionAmount": 0,  
"NkPayingRecoveredEnergyConsumptionAmount": 0,  
"MaPayingRecoveredEnergyConsumptionAmount": 0,  
"VdPayingRecoveredEnergyConsumptionAmount": 0,  
"SvPayingRecoveredEnergyConsumptionAmount": 0,  
"MiPayingRecoveredEnergyConsumptionAmount": 0,  
"VkPayingRecoveredPercentConsumptionAmount": 0,  
"DdPayingRecoveredPercentConsumptionAmount": 0,  
"NkPayingRecoveredPercentConsumptionAmount": 0,  
"MaPayingRecoveredPercentConsumptionAmount": 0,  
"VdPayingRecoveredPercentConsumptionAmount": 0,  
"SvPayingRecoveredPercentConsumptionAmount": 0,  
"MiPayingRecoveredPercentConsumptionAmount": 0,  
"VkPayingRecoveredPowerConsumptionAmount": 0,  
"DdPayingRecoveredPowerConsumptionAmount": 0,  
"NkPayingRecoveredPowerConsumptionAmount": 0,  
"MaPayingRecoveredPowerConsumptionAmount": 0,  
"VdPayingRecoveredPowerConsumptionAmount": 0,  
"SvPayingRecoveredPowerConsumptionAmount": 0,  
"MiPayingRecoveredPowerConsumptionAmount": 0,  
"VkPayingRecoveredMixedConsumptionAmount": 0,  
"DdPayingRecoveredMixedConsumptionAmount": 0,  
"NkPayingRecoveredMixedConsumptionAmount": 0,  
"MaPayingRecoveredMixedConsumptionAmount": 0,  
"VdPayingRecoveredMixedConsumptionAmount": 0,  
"SvPayingRecoveredMixedConsumptionAmount": 0,  
"MiPayingRecoveredMixedConsumptionAmount": 0,  
"VkMissingEnergyConsumptionAmount": 0,  
"VkMissingEnergyViapConsumptionAmount": 0,  
"VkMissingEnergySppdConsumptionAmount": 0,  
"DdMissingEnergyConsumptionAmount": 0,  
"DdMissingEnergyViapConsumptionAmount": 0,  
"DdMissingEnergySppdConsumptionAmount": 0,  
"NkMissingEnergyConsumptionAmount": 0,

"NkMissingEnergyViapConsumptionAmount": 0,  
"NkMissingEnergySppdConsumptionAmount": 0,  
"MaMissingEnergyConsumptionAmount": 0,  
"MaMissingEnergyViapConsumptionAmount": 0,  
"VdMissingEnergyConsumptionAmount": 0,  
"VdMissingEnergyViapConsumptionAmount": 0,  
"SvMissingEnergyConsumptionAmount": 0,  
"SvMissingEnergyViapConsumptionAmount": 0,  
"MiMissingEnergyConsumptionAmount": 0,  
"MiMissingEnergyViapConsumptionAmount": 0,  
"VkMissingEnergyDiscountConsumptionAmount": 0,  
"DdMissingEnergyDiscountConsumptionAmount": 0,  
"NkMissingEnergyDiscountConsumptionAmount": 0,  
"GridSuppliedConsumptionAmount": 0,  
"AccumulatedBeginningConsumptionAmount": 0,  
"AccumulatedEndConsumptionAmount": 0,  
"AccumulatedUploadedConsumptionAmount": 0,  
"AccumulatedRaisedConsumptionAmount": 0,  
"CompensatedConsumptionAmount": 0,  
"OldIndependentSupplier": "string",  
"PowerPlantCapacityConsumptionAmount": 0,  
"EnergyObtainedConsumptionAmount": 0,  
"OperatorGridElectricityConsumptionAmount": 0,  
"ClientGridElectricityConsumptionAmount": 0,  
"PowerPlantCapacityUnit": "string",  
"GaUnit": "string",  
"VkUnit": "string",  
"VkViapUnit": "string",  
"VkSppdUnit": "string",  
"VkDiscountUnit": "string",  
"DdUnit": "string",  
"DdViapUnit": "string",  
"DdSppdUnit": "string",  
"DdDiscountUnit": "string",  
"NkUnit": "string",  
"NkViapUnit": "string",  
"NkSppdUnit": "string",  
"NkDiscountUnit": "string",  
"MaUnit": "string",  
"MaViapUnit": "string",  
"VdUnit": "string",  
"VdViapUnit": "string",

"SvUnit": "string",  
"SvViapUnit": "string",  
"MiUnit": "string",  
"MiViapUnit": "string",  
"RvUnit": "string",  
"RgUnit": "string",  
"VgUnit": "string",  
"Reliability1Unit": "string",  
"Reliability2Unit": "string",  
"Reliability3Unit": "string",  
"TechnologicalCostsViapUnit": "string",  
"TechnologicalCostsUnit": "string",  
"GeneralInterestUnit": "string",  
"VkConsumedElectricityUnit": "string",  
"DdConsumedElectricityUnit": "string",  
"NkConsumedElectricityUnit": "string",  
"MaConsumedElectricityUnit": "string",  
"VdConsumedElectricityUnit": "string",  
"SvConsumedElectricityUnit": "string",  
"MiConsumedElectricityUnit": "string",  
"VkPayingRecoveredEnergyUnit": "string",  
"DdPayingRecoveredEnergyUnit": "string",  
"NkPayingRecoveredEnergyUnit": "string",  
"MaPayingRecoveredEnergyUnit": "string",  
"VdPayingRecoveredEnergyUnit": "string",  
"SvPayingRecoveredEnergyUnit": "string",  
"MiPayingRecoveredEnergyUnit": "string",  
"VkPayingRecoveredPercentUnit": "string",  
"DdPayingRecoveredPercentUnit": "string",  
"NkPayingRecoveredPercentUnit": "string",  
"MaPayingRecoveredPercentUnit": "string",  
"VdPayingRecoveredPercentUnit": "string",  
"SvPayingRecoveredPercentUnit": "string",  
"MiPayingRecoveredPercentUnit": "string",  
"VkPayingRecoveredPowerUnit": "string",  
"DdPayingRecoveredPowerUnit": "string",  
"NkPayingRecoveredPowerUnit": "string",  
"MaPayingRecoveredPowerUnit": "string",  
"VdPayingRecoveredPowerUnit": "string",  
"SvPayingRecoveredPowerUnit": "string",  
"MiPayingRecoveredPowerUnit": "string",  
"VkPayingRecoveredMixedUnit": "string",

"DdPayingRecoveredMixedUnit": "string",  
"NkPayingRecoveredMixedUnit": "string",  
"MaPayingRecoveredMixedUnit": "string",  
"VdPayingRecoveredMixedUnit": "string",  
"SvPayingRecoveredMixedUnit": "string",  
"MiPayingRecoveredMixedUnit": "string",  
"VkMissingEnergyUnit": "string",  
"VkMissingEnergyViapUnit": "string",  
"VkMissingEnergySppdUnit": "string",  
"DdMissingEnergyUnit": "string",  
"DdMissingEnergyViapUnit": "string",  
"DdMissingEnergySppdUnit": "string",  
"NkMissingEnergyUnit": "string",  
"NkMissingEnergyViapUnit": "string",  
"NkMissingEnergySppdUnit": "string",  
"MaMissingEnergyUnit": "string",  
"MaMissingEnergyViapUnit": "string",  
"VdMissingEnergyUnit": "string",  
"VdMissingEnergyViapUnit": "string",  
"SvMissingEnergyUnit": "string",  
"SvMissingEnergyViapUnit": "string",  
"MiMissingEnergyUnit": "string",  
"MiMissingEnergyViapUnit": "string",  
"VkMissingEnergyDiscountUnit": "string",  
"DdMissingEnergyDiscountUnit": "string",  
"NkMissingEnergyDiscountUnit": "string",  
"VkReadingsFrom": 0,  
"DdReadingsFrom": 0,  
"NkReadingsFrom": 0,  
"MaReadingsFrom": 0,  
"VdReadingsFrom": 0,  
"SvReadingsFrom": 0,  
"MiReadingsFrom": 0,  
"RvReadingsFrom": 0,  
"RgReadingsFrom": 0,  
"VkConsumedElectricityReadingsFrom": 0,  
"DdConsumedElectricityReadingsFrom": 0,  
"NkConsumedElectricityReadingsFrom": 0,  
"MaConsumedElectricityReadingsFrom": 0,  
"VdConsumedElectricityReadingsFrom": 0,  
"SvConsumedElectricityReadingsFrom": 0,  
"MiConsumedElectricityReadingsFrom": 0,

"GridSuppliedReadingsFrom": 0,  
"VkReadingsTo": 0,  
"DdReadingsTo": 0,  
"NkReadingsTo": 0,  
"MaReadingsTo": 0,  
"VdReadingsTo": 0,  
"SvReadingsTo": 0,  
"MiReadingsTo": 0,  
"RvReadingsTo": 0,  
"RgReadingsTo": 0,  
"VkConsumedElectricityReadingsTo": 0,  
"DdConsumedElectricityReadingsTo": 0,  
"NkConsumedElectricityReadingsTo": 0,  
"MaConsumedElectricityReadingsTo": 0,  
"VdConsumedElectricityReadingsTo": 0,  
"SvConsumedElectricityReadingsTo": 0,  
"MiConsumedElectricityReadingsTo": 0,  
"GridSuppliedReadingsTo": 0,  
"GaPriceEur": 0,  
"VkPriceEur": 0,  
"VkViapPriceEur": 0,  
"VkSppdPriceEur": 0,  
"VkDiscountPriceEur": 0,  
"DdPriceEur": 0,  
"DdViapPriceEur": 0,  
"DdSppdPriceEur": 0,  
"DdDiscountPriceEur": 0,  
"NkPriceEur": 0,  
"NkViapPriceEur": 0,  
"NkSppdPriceEur": 0,  
"NkDiscountPriceEur": 0,  
"MaPriceEur": 0,  
"MaViapPriceEur": 0,  
"VdPriceEur": 0,  
"VdViapPriceEur": 0,  
"SvPriceEur": 0,  
"SvViapPriceEur": 0,  
"MiPriceEur": 0,  
"MiViapPriceEur": 0,  
"RvPriceEur": 0,  
"RgPriceEur": 0,  
"VgPriceEur": 0,

"Reliability1PriceEur": 0,  
"Reliability2PriceEur": 0,  
"Reliability3PriceEur": 0,  
"TechnologicalCostsViapPriceEur": 0,  
"TechnologicalCostsPriceEur": 0,  
"GeneralInterestPriceEur": 0,  
"VkPayingRecoveredEnergyPriceEur": 0,  
"DdPayingRecoveredEnergyPriceEur": 0,  
"NkPayingRecoveredEnergyPriceEur": 0,  
"MaPayingRecoveredEnergyPriceEur": 0,  
"VdPayingRecoveredEnergyPriceEur": 0,  
"SvPayingRecoveredEnergyPriceEur": 0,  
"MiPayingRecoveredEnergyPriceEur": 0,  
"VkPayingRecoveredMixedPriceEur": 0,  
"DdPayingRecoveredMixedPriceEur": 0,  
"NkPayingRecoveredMixedPriceEur": 0,  
"MaPayingRecoveredMixedPriceEur": 0,  
"VdPayingRecoveredMixedPriceEur": 0,  
"SvPayingRecoveredMixedPriceEur": 0,  
"MiPayingRecoveredMixedPriceEur": 0,  
"VkMissingEnergyPriceEur": 0,  
"VkMissingEnergyViapPriceEur": 0,  
"VkMissingEnergySppdPriceEur": 0,  
"DdMissingEnergyPriceEur": 0,  
"DdMissingEnergyViapPriceEur": 0,  
"DdMissingEnergySppdPriceEur": 0,  
"NkMissingEnergyPriceEur": 0,  
"NkMissingEnergyViapPriceEur": 0,  
"NkMissingEnergySppdPriceEur": 0,  
"MaMissingEnergyPriceEur": 0,  
"MaMissingEnergyViapPriceEur": 0,  
"VdMissingEnergyPriceEur": 0,  
"VdMissingEnergyViapPriceEur": 0,  
"SvMissingEnergyPriceEur": 0,  
"SvMissingEnergyViapPriceEur": 0,  
"MiMissingEnergyPriceEur": 0,  
"MiMissingEnergyViapPriceEur": 0,  
"VkMissingEnergyDiscountPriceEur": 0,  
"DdMissingEnergyDiscountPriceEur": 0,  
"NkMissingEnergyDiscountPriceEur": 0,  
"PowerPlantCapacityPriceEur": 0,  
"GaDiscount": 0,



"VkDiscount": 0,  
"VkViapDiscount": 0,  
"VkSppdDiscount": 0,  
"VkDiscountDiscount": 0,  
"DdDiscount": 0,  
"DdViapDiscount": 0,  
"DdSppdDiscount": 0,  
"DdDiscountDiscount": 0,  
"NkDiscount": 0,  
"NkViapDiscount": 0,  
"NkSppdDiscount": 0,  
"NkDiscountDiscount": 0,  
"MaDiscount": 0,  
"MaViapDiscount": 0,  
"VdDiscount": 0,  
"VdViapDiscount": 0,  
"SvDiscount": 0,  
"SvViapDiscount": 0,  
"MiDiscount": 0,  
"MiViapDiscount": 0,  
"RvDiscount": 0,  
"RgDiscount": 0,  
"VgDiscount": 0,  
"Reliability1Discount": 0,  
"Reliability2Discount": 0,  
"Reliability3Discount": 0,  
"TechnologicalCostsViapDiscount": 0,  
"TechnologicalCostsDiscount": 0,  
"GeneralInterestDiscount": 0,  
"VkPayingRecoveredEnergyDiscount": 0,  
"VkPayingRecoveredMixedDiscount": 0,  
"VkMissingEnergyDiscount": 0,  
"VkMissingEnergyViapDiscount": 0,  
"VkMissingEnergySppdDiscount": 0,  
"VkMissingEnergyDiscountDiscount": 0,  
"GaAmountNoVAT": 0,  
"VkAmountNoVAT": 0,  
"VkViapAmountNoVAT": 0,  
"VkSppdAmountNoVAT": 0,  
"VkDiscountAmountNoVAT": 0,  
"DdAmountNoVAT": 0,  
"DdViapAmountNoVAT": 0,

"DdSppdAmountNoVAT": 0,  
"DdDiscountAmountNoVAT": 0,  
"NkAmountNoVAT": 0,  
"NkViapAmountNoVAT": 0,  
"NkSppdAmountNoVAT": 0,  
"NkDiscountAmountNoVAT": 0,  
"MaAmountNoVAT": 0,  
"MaViapAmountNoVAT": 0,  
"VdAmountNoVAT": 0,  
"VdViapAmountNoVAT": 0,  
"SvAmountNoVAT": 0,  
"SvViapAmountNoVAT": 0,  
"MiAmountNoVAT": 0,  
"MiViapAmountNoVAT": 0,  
"RvAmountNoVAT": 0,  
"RgAmountNoVAT": 0,  
"VgAmountNoVAT": 0,  
"Reliability1AmountNoVAT": 0,  
"Reliability2AmountNoVAT": 0,  
"Reliability3AmountNoVAT": 0,  
"TechnologicalCostsViapAmountNoVAT": 0,  
"TechnologicalCostsAmountNoVAT": 0,  
"GeneralInterestAmountNoVAT": 0,  
"VkPayingRecoveredEnergyAmountNoVAT": 0,  
"DdPayingRecoveredEnergyAmountNoVAT": 0,  
"NkPayingRecoveredEnergyAmountNoVAT": 0,  
"MaPayingRecoveredEnergyAmountNoVAT": 0,  
"VdPayingRecoveredEnergyAmountNoVAT": 0,  
"SvPayingRecoveredEnergyAmountNoVAT": 0,  
"MiPayingRecoveredEnergyAmountNoVAT": 0,  
"VkPayingRecoveredMixedAmountNoVAT": 0,  
"DdPayingRecoveredMixedAmountNoVAT": 0,  
"NkPayingRecoveredMixedAmountNoVAT": 0,  
"MaPayingRecoveredMixedAmountNoVAT": 0,  
"VdPayingRecoveredMixedAmountNoVAT": 0,  
"SvPayingRecoveredMixedAmountNoVAT": 0,  
"MiPayingRecoveredMixedAmountNoVAT": 0,  
"VkMissingEnergyAmountNoVAT": 0,  
"VkMissingEnergyViapAmountNoVAT": 0,  
"VkMissingEnergySppdAmountNoVAT": 0,  
"DdMissingEnergyAmountNoVAT": 0,  
"DdMissingEnergyViapAmountNoVAT": 0,

	<pre>"DdMissingEnergySppdAmountNoVAT": 0, "NkMissingEnergyAmountNoVAT": 0, "NkMissingEnergyViapAmountNoVAT": 0, "NkMissingEnergySppdAmountNoVAT": 0, "MaMissingEnergyAmountNoVAT": 0, "MaMissingEnergyViapAmountNoVAT": 0, "VdMissingEnergyAmountNoVAT": 0, "VdMissingEnergyViapAmountNoVAT": 0, "SvMissingEnergyAmountNoVAT": 0, "SvMissingEnergyViapAmountNoVAT": 0, "MiMissingEnergyAmountNoVAT": 0, "MiMissingEnergyViapAmountNoVAT": 0, "VkMissingEnergyDiscountAmountNoVAT": 0, "DdMissingEnergyDiscountAmountNoVAT": 0, "NkMissingEnergyDiscountAmountNoVAT": 0, "PowerPlantCapacityAmountNoVAT": 0, "PermanentHomePlusAmountNoVAT": 0, "PermanentHomeAmountNoVAT": 0 } ]</pre>				
<b>JSON error response</b>	<pre>{   "errorMessages": [     {       "code": 0,       "text": "string"     }   ] }</pre>				
<b>Rules</b>	<b>No.</b>	<b>Rule description</b>	<b>Error code</b>	<b>Error message</b>	<b>Attribute</b>
	1.	The order status must be Completed.	2010	Invalid report order status.	orderId
	2.	According to the submitted order number: [orderId], the order does not exist.	2016	Report order doesn't exist in the system.	orderId
	3.	Invalid method selected or parameter specified incorrectly. According to the submitted order number: [orderId] report type is: [orderType]	2017	Invalid method selected for report data or incorrect parameter.	orderId orderType

	4.	No data found based on the search parameters submitted in the POST method.	2018	There is no data for the selected search parameters, the response is empty.	orderId
--	----	--	------	---	---------

### 7.12.9.1 JSON Response structure

The table below describes the structure of the JSON response:

Attribute	type	obligation	description
-	-	-	Response description are provided in <a href="https://datahub.eso.lt/dokumentacija">https://datahub.eso.lt/dokumentacija</a> . In next document version, all fields description will be provided here.

### 7.12.9.2 Error Response Structure

The following table describes the JSON structure in the event of a response error:

No.	Attribute	type	obligation	description
1.	code	number	required	Error code.
2.	text	string(4000)	required	Error message.

### 7.12.10 GET/gateway/order/{orderId}/count

<b>URI</b>	GET/gateway/order/{orderId}/count
<b>Description</b>	Method which will return count (number), how many items Supplier will get in ordered report (reports could have more than 1 item, so it is List). It should be used when supplier need to split data in few portions. This response should be used in reports' GET methods request, where Supplier can provide method parameters information.
<b>Parameters</b>	URL parameters:  <b>orderId</b> – order identification number
<b>Header</b>	After decrypting the supplier authentication key, the supplier ID is used to select the data.

<b>JSON request</b>	GET request does not have the BODY part.				
<b>Response</b>	<b>HTTP status code</b>	<b>Reason</b>	<b>Response description</b>		
	200	OK	Request completed successfully		
	204	No content	No data found according to the given parameters.		
	400	Bad Request	Request error. The HTTP response body provides a list of errors in JSON format.		
	401	Unauthorized	An attempt was made to connect to a non-public method that requires authentication, but no user credentials were provided.		
	403	Forbidden	According to the access control policy, the current user does not have access to perform the requested action.		
	404	Not Found	Either there is no API method associated with the request URL path, or the request contains one or more parameters that did not return the data.		
	423	Locked	The source or destination resource of a method is locked. This response SHOULD contain an appropriate precondition or postcondition code, such as 'lock-token-submitted' or 'no-conflicting-lock'.		
<b>JSON Response</b>	<pre>{   "count": "number" }</pre>				
<b>JSON error response</b>	<pre>{   "errorMessages": [     {       "code": 0,       "text": "string"     }   ] }</pre>				
<b>Rules</b>	<b>No.</b>	<b>Rule description</b>	<b>Error code</b>	<b>Error message</b>	<b>Attribute</b>

	1.	The order status must be Completed.	2010	Invalid report order status.	orderId
	2.	According to the submitted order number: [orderId], the order does not exist.	2016	Report order doesn't exist in the system.	orderId
	3.	Invalid method selected or parameter specified incorrectly. According to the submitted order number: [orderId] report type is: [orderType]	2017	Invalid method selected for report data or incorrect parameter.	orderId orderType
	4.	No data found based on the search parameters submitted in the POST method.	2018	There is no data for the selected search parameters, the response is empty.	orderId

#### 7.12.10.1 JSON Request structure

The table below describes the structure of the JSON request:

Attribute	type	obligation	description

#### 7.12.10.2 JSON Response structure

The table below describes the structure of the JSON response:

No.	Attribute	type	obligation	description
1.	count	Number(10)	required	Number of rows, objects, accounts, depending on the selected report.

#### 7.12.10.3 Error Response Structure

The following table describes the JSON structure in the event of a response error:

No.	Attribute	type	obligation	description
1.	code	number	required	Error code.

No.	Attribute	type	obligation	description
2.	text	string(4000)	required	Error message.

### 7.12.11 POST/gateway/order/data-hr-15min-mtr-lvl-acr

<b>URI</b>	POST/gateway/order/data-hr-15min-mtr-lvl-acr		
<b>Description</b>	The method is designed for ordering data for automated quantities at the counter level according to the rights granted.		
<b>Parameters</b>	URL: The JSON data is contained in the HTTP request (BODY) ( <i>see JSON structure, below</i> ).		
<b>Header</b>	After decrypting the supplier authentication key, the supplier ID is used to select the data.		
<b>JSON request</b>	<pre>{   "dateFrom": "date",   "dateTo": "date",   "consumptionCategories":[string, string],   "objectNumbers":[string, string],   "interval":"string" }</pre>		
<b>Response HTTP code</b>	<b>HTTP status code</b>	<b>Reason</b>	<b>Description</b>
	201	Created	The request has been successfully completed.
	400	Bad Request	Request error. The HTTP response body provides a list of errors in JSON format. ( <i>Error response of the JSON structure below</i> ).

	401	Unauthorized	An attempt was made to connect to a non-public method that requires authentication, but no user credentials were provided.		
	403	Forbidden	According to the access control policy, the current user does not have access to perform the requested action.		
	404	Not Found	Either there is no API method associated with the request URL path, or the request contains one or more parameters that did not return the data.		
<b>JSON response</b>	<pre>{   "orderId": "number" }</pre>				
<b>JSON error response</b>	<pre>{   "errorMessages": [     {       "code": 0,       "text": "string"     }   ] }</pre>				
<b>Rules</b>	<b>No.</b>	<b>Rule description</b>	<b>Error code</b>	<b>Error message</b>	<b>Attributes</b>
	1.	If an attribute has defined possible values, the value index can be specified by specifying the value of the attribute in the request. Indices of all possible values start from 0.	-	-	All attributes with specified values.
	2.	Date format is incorrect.	-	-	dateFrom dateTo
	3.	The date from cannot be later than the date to, but can be equal.	1002	Date from cannot be later than date to.	dateFrom dateTo



4.	The date from cannot be later than the current date, but can be equal.	2003	Date from cannot be later than the current date.	dateFrom
5.	Object meter must be automated.	2007	The submitted object number: [objectNumber (if there is more than one object, objects must be separated by the semicolon)], was not found or the meter of object is not automated.	objectNumbers
6.	Data cannot be older than 36 months old.	2012	Date from date cannot be older than 36 months old.	dateFrom
7.	Report can be ordered maximum for 12 months.	2013	The report can only be ordered for 12 months or less.	dateFrom dateTo
8.	The period date from and date to must be less than date from configurable parameter.	2015	Data is not currently available for the selected reporting period.	dateFrom dateTo
9.	The object must have a valid access right.	2020	Object [objectNumber (if there is more than one object, objects must be separated by the semicolon)] does not have a access right or access right is expired.	objectNumbers
10.	A maximum of 500 objects can be submitted in a report order	2021	A maximum of 500 objects can be submitted in a report order	objectNumbers

#### 7.12.11.1 JSON Request structure

The table below describes the structure of the JSON request:

No.	Attribute	type	obligation	description
1.	dateFrom	Date	required	The beginning of the reporting period: <ul style="list-style-type: none"> <li>The format: YYYY-MM-DD;</li> </ul> The reporting period start date is the first day of the month.

2.	dateTo	Date	required	The end of the reporting period: <ul style="list-style-type: none"> <li>The format: YYYY-MM-DD;</li> </ul> The reporting period end date is the last day of the month.
3.	consumptionCategory	String(20)	required	The consumption category. Possible meanings: <ul style="list-style-type: none"> <li>P+;</li> <li>P-;</li> <li>Q+;</li> <li>Q-;</li> </ul>
4.	objectNumbers	String	required	Object number.
5.	interval	String	required	Consumption interval. Possible meanings: <ul style="list-style-type: none"> <li>- HOUR</li> <li>- QUARTER</li> </ul>

#### 7.12.11.2 JSON Response structure

The table below describes the structure of the JSON response:

No.	Attribute	type	obligation	description
1.	orderId	Integer	required	The report ordering primary surrogate key.

#### 7.12.11.3 Error Response Structure

The following table describes the JSON structure in the event of a response error:

No.	Attribute	type	obligation	description
1.	code	number	required	Error code.
2.	text	string(4000)	required	Error message.

#### 7.12.12 POST/gateway/order/data-hr-15min-obj-lvl-acr

<b>URI</b>	POST/gateway/order/data-hr-15min-obj-lvl-acr		
<b>Description</b>	The method is designed for ordering data for automated quantities at the object level according to the rights granted.		
<b>Parameters</b>	URL: The JSON data is contained in the HTTP request (BODY) (see <i>JSON structure, below</i> ).		
<b>Header</b>	After decrypting the supplier authentication key, the supplier ID is used to select the data.		
<b>JSON request</b>	<pre>{   "dateFrom": "date",   "dateTo": "date",   "consumptionCategories": [string, string],   "objectNumbers": [string, string],   "interval": "string" }</pre>		
<b>Response HTTP code</b>	<b>HTTP status code</b>	<b>Reason</b>	<b>Description</b>
	201	Created	The request has been successfully completed.
	400	Bad Request	Request error. The HTTP response body provides a list of errors in JSON format. ( <i>Error response of the JSON structure below</i> ).
	401	Unauthorized	An attempt was made to connect to a non-public method that requires authentication, but no user credentials were provided.
	403	Forbidden	According to the access control policy, the current user does not have access to perform the requested action.
	404	Not Found	Either there is no API method associated with the request URL path, or the request contains one or more parameters that did not return the data.
<b>JSON response</b>	<pre>{   "orderId": "number" }</pre>		
<b>JSON error response</b>	<pre>{   "errorMessages": [</pre>		

```

{
  "code": 0,
  "text": "string"
}
]
}

```

Rules	No.	Rule description	Error code	Error message	Attributes
	1.	If an attribute has defined possible values, the value index can be specified by specifying the value of the attribute in the request. Indices of all possible values start from 0.	-	-	All attributes with specified values.
	2.	Date format is incorrect.	-	-	dateFrom dateTo
	3.	The date from cannot be later than the date to, but can be equal.	1002	Date from cannot be later than date to.	dateFrom dateTo
	4.	The date from cannot be later than the current date, but can be equal.	2003	Date from cannot be later than the current date.	dateFrom
	5.	Object meter must be automated.	2007	The submitted object number: [objectNumber (if there is more than one object, objects must be separated by the semicolon)], was not found or the meter of object is not automated.	objectNumbers
	6.	Data cannot be older than 36 months old.	2012	Date from date cannot be older than 36 months old.	dateFrom
	7.	Report can be ordered maximum for 12 months.	2013	The report can only be ordered for 12 months or less.	dateFrom dateTo

	8.	The period date from and date to must be less than date from configurable parameter.	2015	Data is not currently available for the selected reporting period.	dateFrom dateTo
	9.	The object must have a valid access right.	2020	Object [objectNumber (if there is more than one object, objects must be separated by the semicolon)] does not have a access right or access right is expired.	objectNumbers
	10.	A maximum of 500 objects can be submitted in a report order	2021	A maximum of 500 objects can be submitted in a report order	objectNumbers

### 7.12.12.1 JSON Request structure

The table below describes the structure of the JSON request:

No.	Attribute	type	obligation	description
1.	dateFrom	Date	required	The beginning of the reporting period: <ul style="list-style-type: none"> <li>The format: YYYY-MM-DD;</li> </ul> The reporting period start date is the first day of the month.
2.	dateTo	Date	required	The end of the reporting period: <ul style="list-style-type: none"> <li>The format: YYYY-MM-DD;</li> </ul> The reporting period end date is the last day of the month.
3.	consumptionCategory	String(20)	required	The consumption category. Possible meanings: <ul style="list-style-type: none"> <li>P+;</li> <li>P-;</li> <li>Q+;</li> <li>Q-;</li> </ul>
4.	objectNumbers	String	required	Object number.
5.	interval	String	required	Consumption interval. Possible meanings: <ul style="list-style-type: none"> <li>- HOUR</li> <li>- QUARTER</li> </ul>

### 7.12.12.2 JSON Response structure

The table below describes the structure of the JSON response:

No.	Attribute	type	obligation	description
1.	orderId	Integer	required	The report ordering primary surrogate key.

### 7.12.12.3 Error Response Structure

The following table describes the JSON structure in the event of a response error:

No.	Attribute	type	obligation	description
1.	code	number	required	Error code.
2.	text	string(4000)	required	Error message.

### 7.12.13 POST/gateway/order/data-sum-obj-lvl-acr

<b>URI</b>	POST/gateway/order/data-sum-obj-lvl-acr			
<b>Description</b>	The method is for order a report of total quantities according to the granted rights.			
<b>Parameters</b>	URL: The JSON data is contained in the HTTP request (BODY) ( <i>see JSON structure, below</i> ).			
<b>Header</b>	After decrypting the supplier authentication key, the supplier ID is used to select the data.			
<b>JSON request</b>	<pre>{   "dateFrom": "date",   "dateTo": "date",   "objectNumbers": ["string"] }</pre>			
<b>Response HTTP code</b>	<b>HTTP status code</b>	<b>Reason</b>	<b>Description</b>	

201	Created	The request has been successfully completed.
400	Bad Request	Request error. The HTTP response body provides a list of errors in JSON format. ( <i>Error response of the JSON structure below</i> ).
401	Unauthorized	An attempt was made to connect to a non-public method that requires authentication, but no user credentials were provided.
403	Forbidden	According to the access control policy, the current user does not have access to perform the requested action.
404	Not Found	Either there is no API method associated with the request URL path, or the request contains one or more parameters that did not return the data.

<b>JSON response</b>	<pre>{   "orderId": "number" }</pre>				
<b>JSON error response</b>	<pre>{   "errorMessages": [     {       "code": 0,       "text": "string"     }   ] }</pre>				
<b>Rules</b>	<b>No.</b>	<b>Rule description</b>	<b>Error code</b>	<b>Error message</b>	<b>Attributes</b>
	1.	Date format is incorrect.	-	-	dateFrom dateTo
	2.	The date from cannot be later than the date to, but can be equal.	1002	Date from cannot be later than date to.	dateFrom dateTo
	3.	Data cannot be older than 36 months old.	2012	Date from date cannot be older than 36 months old.	dateFrom

	5.	The period date from and date to must be less than date from configurable parameter.	2015	Data is not currently available for the selected reporting period.	dateFrom dateTo
	6.	The object must have a valid access right.	2020	Object [objectNumbers (if there is more than one object, objects must be separated by the semicolon)] does not have a access right or access right is expired.	objectNumbers
	7.	A maximum of 500 objects can be submitted in a report order.	2021	A maximum of 500 objects can be submitted in a report order.	objectNumbers
	8.	The date from and date to cannot be later than the current date, but can be equal.	2025	Date from and date to cannot be later than the current date.	dateFrom dateTo
	9.	dateFrom - must be the first day of the month;  dateTo - must be the last day of the month, unless dateTo coincides with the current month, then must be currentDate	2009	Date from must be the first day of the month. Date to must be the last day of the month, unless date to coincides with the current day.	dateFrom dateTo

### 7.12.13.1 JSON Request structure

The table below describes the structure of the JSON request:

No.	Attribute	type	obligation	description
1.	dateFrom	Date	required	The beginning of the reporting period: <ul style="list-style-type: none"> <li>The format: YYYY-MM-DD;</li> </ul> The reporting period start date is the first day of the month.
2.	dateTo	Date	required	The end of the reporting period: <ul style="list-style-type: none"> <li>The format: YYYY-MM-DD;</li> </ul> The reporting period end date is the last day of the month.



4.	objectNumbers	String	required	Object numbers.
----	---------------	--------	----------	-----------------

### 7.12.13.2 JSON Response structure

The table below describes the structure of the JSON response:

No.	Attribute	type	obligation	description
1.	orderId	Integer	required	The report ordering primary surrogate key.

### 7.12.13.3 Error Response Structure

The following table describes the JSON structure in the event of a response error:

No.	Attribute	type	obligation	description
1.	code	number	required	Error code.
2.	text	string(4000)	required	Error message.

### 7.12.14 POST/gateway/order/report-obj-acr

<b>URI</b>	POST /gateway/order/report-obj-acr
<b>Description</b>	The method is for order a report of objects according to the granted rights.
<b>Parameters</b>	URL: The JSON data is contained in the HTTP request (BODY) ( <i>see JSON structure, below</i> ).
<b>Header</b>	After decrypting the supplier authentication key, the supplier ID is used to select the data.
<b>JSON request</b>	<pre>{   "objectNumbers":["string"] }</pre>

Response HTTP code	HTTP status code	Reason	Description		
	201	Created	The request has been successfully completed.		
	400	Bad Request	Request error. The HTTP response body provides a list of errors in JSON format. ( <i>Error response of the JSON structure below</i> ).		
	401	Unauthorized	An attempt was made to connect to a non-public method that requires authentication, but no user credentials were provided.		
	403	Forbidden	According to the access control policy, the current user does not have access to perform the requested action.		
	404	Not Found	Either there is no API method associated with the request URL path, or the request contains one or more parameters that did not return the data.		
<b>JSON response</b>	<pre>{   "orderId": "number" }</pre>				
<b>JSON error response</b>	<pre>{   "errorMessages": [     {       "code": 0,       "text": "string"     }   ] }</pre>				
Rules	No.	Rule description	Error code	Error message	Attributes
	1.	The object must have a valid access right.	2020	Object [objectNumbers (if there is more than one object, objects must be separated by the semicolon)] does not have a access right or access right is expired.	objectNumbers

	2.	A maximum of 500 objects can be submitted in a report order.	2021	A maximum of 500 objects can be submitted in a report order.	objectNumbers
--	----	--	------	--	---------------

#### 7.12.14.1 JSON Request structure

The table below describes the structure of the JSON request:

No.	Attribute	type	obligation	description
1.	objectNumbers	String	required	Object numbers.

#### 7.12.14.2 JSON Response structure

The table below describes the structure of the JSON response:

No.	Attribute	type	obligation	description
1.	orderId	Integer	required	The report ordering primary surrogate key.

#### 7.12.14.3 Error Response Structure

The following table describes the JSON structure in the event of a response error:

No.	Attribute	type	obligation	description
1.	code	number	required	Error code.
2.	text	string(4000)	required	Error message.

#### 7.12.15 GET /gateway/order/{orderId}/data-hr-15min-obj-lvl-acr?first={integer}&count={integer}

<b>URI</b>	GET /gateway/order/{orderId}/data-hr-15min-obj-lvl-acr?first={integer}&count={integer}
<b>Description</b>	The method for receive the order report "Automated quantities at the object level according to the granted rights".

<b>Parameters</b>	<p>URL parameters:</p> <p><b>orderId</b> – order identification number</p> <p><b>first</b> - the index of the object, which must be the first in the return list (starting from 0). Optional. The default value is 0.</p> <p><b>count</b> - the number of objects in the return list. Optional. <a href="#">The default value is 10000. If no count value is given, the default value count will be 10000.</a></p>		
<b>Header</b>	After decrypting the supplier authentication key, the supplier ID is used to select the data.		
<b>JSON request</b>			
<b>Response HTTP code</b>	<b>HTTP status code</b>	<b>Reason</b>	<b>Description</b>
	200	OK	Request completed successfully.
	204	No content	No data found according to the given parameters.
	400	Bad Request	Request error. The HTTP response body provides a list of errors in JSON format. ( <i>Error response of the JSON structure below</i> ).
	401	Unauthorized	An attempt was made to connect to a non-public method that requires authentication, but no user credentials were provided.
	403	Forbidden	According to the access control policy, the current user does not have access to perform the requested action.
	404	Not Found	Either there is no API method associated with the request URL path, or the request contains one or more parameters that did not return the data.
<b>JSON response</b>	<pre>{   "personCode": "string",   "personName": "string",</pre>		

	<pre> "personSurname": "string", "objectId": number, "objectNumber": "string", "consumptionCategories": [   {     "consumptionCategory": "string",     "consumptions": [       {         "consumptionTime": "datetime",         "amount": number       }     ]   } ] </pre>				
<b>JSON error response</b>	<pre> {   "errorMessages": [     {       "code": 0,       "text": "string"     }   ] } </pre>				
<b>Rules</b>	<b>No.</b>	<b>Rule description</b>	<b>Error code</b>	<b>Error message</b>	<b>Attributes</b>

	1.	The order status must be Completed.		2010	Invalid report order status.	orderId
	2.	According to the submitted order number: [orderId], the order does not exist.		2016	Report order doesn't exist in the system.	orderId
	3.	Invalid method selected or parameter specified incorrectly. According to the submitted order number: [orderId] report type is: [orderType]	2017	Invalid method selected for report data or incorrect parameter.		orderId orderType
	4.	No data found based on the search parameters submitted in the POST method.	2018	There is no data for the selected search parameters, the response is empty.	orderId	

#### 7.12.15.1 JSON Request structure

The table below describes the structure of the JSON request:

No.	Attribute	type	obligation	description

#### 7.12.15.2 JSON Response structure

The table below describes the structure of the JSON response:

No.	Attribute	type	obligation	description
1.	personCode	String(20)	required	Person code.
2.	personName	String(200)	required	Person name / company name.
3.	personSurname	String(50)	required	Person surname.
4.	objectId	Integer	required	Object ID.

5.	objectNumber	String(20)	required	Object number.
consumptionCategories:[]				
8.	consumptionCategory	String(2)	required	Consumption category. Possible meanings: <ul style="list-style-type: none"> <li>• P+;</li> <li>• P-;</li> <li>• Q+;</li> <li>• Q-.</li> </ul>
consumptions:[]				
	consumptionTime	datetime	required	Consumption time. Example of consumptionTime format: 2022-06-07T00:00:00+02:00 2022-06-07T00:00:00+03:00
9.	amount	number	required	Consumption amount.

### 7.12.15.3 Error Response Structure

The following table describes the JSON structure in the event of a response error:

No.	Attribute	type	obligation	description
1.	code	number	required	Error code.
2.	text	string(4000)	required	Error message.

### 7.12.16 GET /gateway/order/{orderId}/data-hr-15min-mtr-lvl-acr?first={integer}&count={integer}

<b>URI</b>	GET /gateway/order/{ orderId }/data-hr-15min-mtr-lvl-acr?first={ integer }&count={ integer }
<b>Description</b>	The method for receive the order report " Automated quantities at the meter level based on granted rights".
<b>Parameters</b>	URL parameters:  <b>orderId</b> – order identification number <b>first</b> - the index of the object, which must be the first in the return list (starting from 0). Optional. The default value is 0.

	<b>count</b> - the number of objects in the return list. Optional. <a href="#">The default value is 10000. If no count value is given, the default value count will be 10000.</a>		
<b>Header</b>	After decrypting the supplier authentication key, the supplier ID is used to select the data.		
<b>JSON request</b>			
<b>Response HTTP code</b>	<b>HTTP status code</b>	<b>Reason</b>	<b>Description</b>
	200	OK	Request completed successfully.
	204	No content	No data found according to the given parameters.
	400	Bad Request	Request error. The HTTP response body provides a list of errors in JSON format. ( <i>Error response of the JSON structure below</i> ).
	401	Unauthorized	An attempt was made to connect to a non-public method that requires authentication, but no user credentials were provided.
	403	Forbidden	According to the access control policy, the current user does not have access to perform the requested action.
	404	Not Found	Either there is no API method associated with the request URL path, or the request contains one or more parameters that did not return the data.
<b>JSON response</b>	<pre>[   {     "personCode":"string",     "personName":"string",     "personSurname":"string",     "objectId":number,     "objectNumber":"string",</pre>		



```
"meters":[
  {
    "meterNumber":"string",
    "categories":[
      {
        "consumptionCategory":"string",
        "consumptions":[
          {
            "consumptionTime":"datetime",
            "amount":number
          }
        ]
      }
    ]
  }
]
```

**JSON error response**

```
{
  "errorMessages": [
    {
      "code": 0,
      "text": "string"
    }
  ]
}
```

	}				
Rules	No.	Rule description	Error code	Error message	Attributes
	1.	The order status must be Completed.	2010	Invalid report order status.	orderId
	2.	According to the submitted order number: [orderId], the order does not exist.	2016	Report order doesn't exist in the system.	orderId
	3.	Invalid method selected or parameter specified incorrectly. According to the submitted order number: [orderId] report type is: [orderType]	2017	Invalid method selected for report data or incorrect parameter.	orderId orderType
	4.	No data found based on the search parameters submitted in the POST method.	2018	There is no data for the selected search parameters, the response is empty.	orderId

#### 7.12.16.1 JSON Request structure

The table below describes the structure of the JSON request:

No.	Attribute	type	obligation	description

#### 7.12.16.2 JSON Response structure

The table below describes the structure of the JSON response:

No.	Attribute	type	obligation	description
1.	personCode	String(20)	required	Person code.
2.	personName	String(200)	required	Person name / company name.
3.	personSurname	String(50)	required	Person surname.

4.	objectId	Integer	required	Object ID.
5.	objectNumber	String(20)	required	Object number.
meters:[]				
6.	meterNumber	String(20)	required	Meter number of the object.
categories:[]				
7.	consumptionCategory	String(2)	required	Consumption category. Possible meanings: <ul style="list-style-type: none"> <li>• P+;</li> <li>• P-;</li> <li>• Q+;</li> <li>• Q-.</li> </ul>
consumptions:[]				
8.	consumptionTime	Datetime	required	Consumption time. Example of consumptionTime format: 2022-06-07T00:00:00+02:00 2022-06-07T00:00:00+03:00
9.	amount	Number	required	Consumption amount.

### 7.12.16.3 Error Response Structure

The following table describes the JSON structure in the event of a response error:

No.	Attribute	type	obligation	description
1.	code	number	required	Error code.
2.	text	string(4000)	required	Error message.

### 7.12.17 GET /gateway/order/{orderId}/report-obj-acr?first={integer}&count={integer}

<b>URI</b>	GET /gateway/order/{orderId}/report-obj-acr?first={integer}&count={integer}
<b>Description</b>	The method for used to the order report "Report of objects by granted rights".

<b>Parameters</b>	<p>URL parameters:</p> <p><b>orderId</b> – order identification number</p> <p><b>first</b> - the index of the object, which must be the first in the return list (starting from 0). Optional. The default value is 0.</p> <p><b>count</b> - the number of objects in the return list. Optional. <a href="#">The default value is 10000. If no count value is given, the default value count will be 10000.</a></p>		
<b>Header</b>	After decrypting the supplier authentication key, the supplier ID is used to select the data.		
<b>JSON request</b>			
<b>Response HTTP code</b>	<b>HTTP status code</b>	<b>Reason</b>	<b>Description</b>
	200	OK	Request completed successfully.
	204	No content	No data found according to the given parameters.
	400	Bad Request	Request error. The HTTP response body provides a list of errors in JSON format. ( <i>Error response of the JSON structure below</i> ).
	401	Unauthorized	An attempt was made to connect to a non-public method that requires authentication, but no user credentials were provided.
	403	Forbidden	According to the access control policy, the current user does not have access to perform the requested action.
	404	Not Found	Either there is no API method associated with the request URL path, or the request contains one or more parameters that did not return the data.
<b>JSON response</b>	<pre>[ { "consumerCode":"string", "personCode":"string", "personName":"string", "personSurname":"string", "objectId":"number",</pre>		

	<pre> "objectNumber": "string", "objectName": "string", "objectType": "string", "objectAddress": "string", "contractType": "string", "contractModel": "string", "permissiblePowerConsumption": "number", "permissiblePowerGeneration": "number", "metersAmount": "number", "autoMetersAmount": "number", "smartMeterInstallationDate": "date", "supplyState": "string", "supplyStateFrom": "date", "supplyStateTo": "date", "consumptionState": "string", "consumptionStateFrom": "date", "consumptionStateTo": "date", "productsAmount": "number", "scalesAmount": "number", "technologicalCosts": "boolean", "payoffMethod": "string", "generatingObjectType": "string", "generatingObjectTypeFrom": "date", "generatingObjectTypeTo": "date", "powerPlantType": "string", "voltage": "number", "tariffPlan": "string", "tariffPlanChangeDate": "date",  "timeZone": "string" } ] </pre>
<b>JSON error response</b>	<pre> {   "errorMessages": [ </pre>

	<pre> {   "code": 0,   "text": "string" } ] } </pre>				
Rules	No.	Rule description	Error code	Error message	Attributes
	1.	The order status must be Completed.	2010	Invalid report order status.	orderId
	2.	According to the submitted order number: [orderId], the order does not exist.	2016	Report order doesn't exist in the system.	orderId
	3.	Invalid method selected or parameter specified incorrectly. According to the submitted order number: [orderId] report type is: [orderType]	2017	Invalid method selected for report data or incorrect parameter.	orderId orderType
	4.	No data found based on the search parameters submitted in the POST method.	2018	There is no data for the selected search parameters, the response is empty.	orderId

#### 7.12.17.1 JSON Request structure

The table below describes the structure of the JSON request:

No.	Attribute	type	obligation	description

#### 7.12.17.2 JSON Response structure

The table below describes the structure of the JSON response:

No.	Attribute	type	obligation	description

1.	-	-	-	Response description are provided in <a href="https://datahub.eso.lt/dokumentacija">https://datahub.eso.lt/dokumentacija</a> . In next document version, all fields description will be provided here.
----	---	---	---	--

### 7.12.17.3 Error Response Structure

The following table describes the JSON structure in the event of a response error:

No.	Attribute	type	obligation	description
1.	code	number	required	Error code.
2.	text	string(4000)	required	Error message.

### 7.12.18 GET /gateway/order/{orderId}/data-sum-obj-lvl-acr?first={integer}&count={integer}

<b>URI</b>	GET /gateway/order/{orderId}/data-sum-obj-lvl-acr?first={integer}&count={integer}		
<b>Description</b>	The method is used to obtain the requested "Aggregate quantities by entitlement" report.		
<b>Parameters</b>	<p>URL parameters:</p> <p><b>orderId</b> – order identification number</p> <p><b>first</b> - the index of the object, which must be the first in the return list (starting from 0). Optional. The default value is 0.</p> <p><b>count</b> - the number of objects in the return list. Optional. <b>The default value is 10000. If no count value is given, the default value count will be 10000.</b></p>		
<b>Header</b>	After decrypting the supplier authentication key, the supplier ID is used to select the data.		
<b>JSON request</b>			
<b>Response HTTP code</b>	<b>HTTP status code</b>	<b>Reason</b>	<b>Description</b>
	200	OK	Request completed successfully.
	204	No content	No data found according to the given parameters.

	400	Bad Request	Request error. The HTTP response body provides a list of errors in JSON format. ( <i>Error response of the JSON structure below</i> ).
	401	Unauthorized	An attempt was made to connect to a non-public method that requires authentication, but no user credentials were provided.
	403	Forbidden	According to the access control policy, the current user does not have access to perform the requested action.
	404	Not Found	Either there is no API method associated with the request URL path, or the request contains one or more parameters that did not return the data.

<b>JSON response</b>	<pre>[   {     "personCode":"string",     "personName":"string",     "personSurname":"string",     "objectId":"number",     "objectNumber":"string",     "products":[       {         "productCode":"string",         "productName":"string",         "productType":"string",         "unit":"string",         "consumptionCategories": [           {             "category":"string",             "consumptions":[               {                 "billingPeriod":"date",                 "consumptionAmount":"number",                 "productConsumptionType":"string"               }             ]           }         ]       }     ]   } ]</pre>		
----------------------	---	--	--





No.	Attribute	type	obligation	description

### 7.12.18.2 JSON Response structure

The table below describes the structure of the JSON response:

No.	Attribute	type	obligation	description
1.	personCode	String(20)	required	Person code.
2.	personName	String(20)	required	Person name.
3.	personSurname	String(50)	not required	Person surname.
4.	objectId	number	required	Object ID.
5.	objectNumber	String	required	Object number.
Products:[]				
6.	productCode	String(20)	not required	Product code.
7.	productName	String(4000)	not required	Product name.
8.	productType	String(5)	required	Product type.
9.	unit	String(255)	not required	The unit of the product.
consumptionCategories:[]				
10.	category	String(2)	required	Consumption category.
Consumptions:[]				

11.	billingPeriod	Datetime	required	Month in which electricity consumption is recorded.
	consumptionAmount	number	required	The amount of the consumption
	productConsumptionType	String(20)	not required	Type of the product consumption. Possible meanings: - AMS - Abonentinis mok. (Subscription fee)

### 7.12.18.3 Error Response Structure

The following table describes the JSON structure in the event of a response error:

No.	Attribute	type	obligation	description
1.	code	number	required	Error code.
2.	text	string(4000)	required	Error message.

## 7.13 Notification cancellation – new

### 7.13.1 POST /gateway/notification/cancellation/list?first={integer}&count={integer}&sortOrder={ASC/DSC}

<b>URI</b>	POST /gateway/notification/cancellation/list?first={integer}&count={integer}&sortOrder={ASC/DSC}
<b>Description</b>	The method is designed to obtain notification cancelation request for NTK
<b>Parameters</b>	<p><b>URL:</b></p> <ul style="list-style-type: none"> <li>• <b>first</b> - index (starting from 0) of the notification that must be presented first in the return list. Optional. The default value is 0.</li> <li>• <b>count</b> - number of notification in the return list. Optional. The default value is 30.</li> <li>• <b>sort</b> - possible values ASC, DSC.</li> </ul>

	<ul style="list-style-type: none"> <li>By default, the list must be sorted by the column "notificationId". The most recent request records must be displayed at the top of the list;</li> <li>It shall be possible to sort the list entries by all fields in the list, except status history;</li> </ul> <p>The data of the JSON form request are presented in the HTTP request body (<b>BODY</b>) (Query JSON structure, below).</p>		
<b>Header</b>	After decrypting the supplier authentication key, the supplier ID is used to select the data.		
<b>JSON request</b>	<pre>{   "notificationId": "number",   "cancelledNotificationId": "number",   "cancelledNotificationType": [     "string"   ],   "objectNumber": "string",   "objectAddressSearch": "string",   "submittedDateFrom": "datetime",   "submittedDateTo": "datetime",   "status": [     "string"   ],   "userNameSearch": "string" }</pre>		
<b>Response HTTP code</b>	<b>HTTP status code</b>	<b>Reason</b>	<b>Description</b>
	200	OK	Request completed successfully
	204	No Content	No data found according to the given parameters.
	400	Bad Request	Request error. The HTTP response body provides a list of errors in JSON format. ( <i>Error response of the JSON structure below</i> ).
	401	Unauthorized	An attempt was made to connect to a non-public method that requires authentication, but no user credentials were provided.
	403	Forbidden	According to the access control policy, the current user does not have access to perform the requested action.

	404	Not Found	Either there is no API method associated with the request URL path, or the request contains one or more parameters that did not return the data.		
<b>JSON response</b>	<pre>[   {     "notificationId":"number",     "cancelledNotificationId":"number",     "cancelledNotificationType":"string",     "cancelledFullNotification":"boolean",     "userName":"string",     "submittedDate":"datetime",     "latestStatus":"string",     "errorType":"string",     "objects":[       {         "objectNumber":"string",         "objectAddress":"string"       }     ],     "notificationStatus":[       {         "status":"string",         "statusDate":"datetime"       }     ]   } ]</pre>				
<b>JSON error response</b>	<pre>{   "errorMessages": [     {       "code": 0,       "text": "string"     }   ] }</pre>				
<b>Rules</b>	<b>No.</b>	<b>Rule description</b>	<b>Error code</b>	<b>Error message</b>	<b>Attributes</b>
	0.	If an attribute has defined possible values, the value index can be specified by specifying the value of the	-	-	-

		attribute in the request. Indices of all possible values start from 0.			
	1.	No data found according to the given parameters.	HTTP 204	-	-
	2.	One or more request parameters are required.	1001	One or more request parameters are required.	-
	3.	DateFrom cannot be later than DateTo. Equal can be.	1002	One or more request parameters are required.	submittedDateFrom

### 7.13.1.1 JSON Request structure

The table below describes the structure of the JSON request:

No.	Attribute	type	obligation	description
1.	notificationId	Integer	not required	Request identifier. Search is possible by full value
2.	cancelledNotificationId	Integer	not required	Identifier of the cancelation request. Search is possible by full value
3.	cancelledNotificationType	String:[]	not required	<p>Cancelation request type. Possible values:</p> <ul style="list-style-type: none"> <li>• STK - owner and supplier change</li> <li>• NTK - supplier change</li> <li>• SK - owner change</li> <li>• SN - termination of contract</li> <li>• KT - change of contacts</li> <li>• TPK - Change of tariff plans</li> <li>• AP - Disconnect / connect</li> </ul> <p>More then one type can be submitted</p>
4.	objectNumber	String(20)	not required	Object number. Search is possible by full value
5.	objectAddressSearch	String(4000)	not required	Object address. Search by the fragment.
6.	submittedDateFrom	DateTime	not required	Date of submission "from".

No.	Attribute	type	obligation	description
7.	submittedDateTo	DateTime	not required	Date of submission "to".
8.	status	String:[]	not required	<p>Message status. The possible values are:</p> <ul style="list-style-type: none"> <li>• P – Submitted</li> <li>• A – Cancelled</li> <li>• I – Sent</li> <li>• V - In progress</li> <li>• IV - Completed</li> <li>• K - Error</li> </ul> <p>More then one type can be submitted.</p>
9.	userNameSearch	String(240)	not required	Search by fragment

### 7.13.1.2 JSON Response structure

The table below describes the structure of the JSON response:

No.	Attribute	type	obligation	description
1.	notificationId	Integer	required	Request identifier.
2.	cancelledNotificationId	Integer	required	Identifier of the cancelation request.
3.	cancelledNotificationType	String(10)	required	<p>Cancelation request type. Possible values are:</p> <ul style="list-style-type: none"> <li>• STK - owner and supplier change</li> <li>• NTK - supplier change</li> <li>• SK - owner change</li> <li>• SN - termination of contract</li> <li>• KT - change of contacts</li> <li>• TPK - Change of tariff plans</li> <li>• AP - Disconnect / connect</li> </ul>

No.	Attribute	type	obligation	description
	cancelledFullNotification	Boolean	required	Attribute indicating whether all objects are canceled with cancelation request. If all – then response “YES”, if no – the response “No”.
4.	userName	String(240)	not required	User, that created entry
5.	submittedDate	DateTime	required	Date of notification
6.	latestStatus	String(10)	required	<p>Latest status of message. The possible values are:</p> <ul style="list-style-type: none"> <li>• P – Submitted</li> <li>• A – Cancelled</li> <li>• I – Sent</li> <li>• V - In progress</li> <li>• IV – Completed</li> <li>• K - Error</li> </ul>
7.	errorType	String(10)	not required	<p>Responde in case of error. The value is returned only if the status is "K – Error"</p> <p>Possible meanings are:</p> <ul style="list-style-type: none"> <li>• KL - Incorrect message</li> <li>• AT - Cancellation of a supplier is not possible because the object has already entered into NT</li> <li>• AN - Supplier cancellation is not possible because the object in the NT does not match the Billing data</li> <li>• AS - Cancellation of a supplier is not possible because the details of the old contract do not match</li> </ul>
objects:[]				
8.	objectNumber	String(20)	not required	Object number
9.	objectAddress	String(4000)	not required	Object address
notificationStatus:[]				



No.	Attribute	type	obligation	description
10.	status	String(10)	required	Message status. The possible values are: <ul style="list-style-type: none"> <li>• P – Submitted</li> <li>• A – Cancelled</li> <li>• I – Sent</li> <li>• V - In progress</li> <li>• IV – Completed</li> <li>• K -Error</li> </ul>
11.	statusDate	DateTime	required	Status date

### 7.13.1.3 Error Response structure

The following table describes the JSON structure in the event of a response error:

No.	Attribute	type	obligation	description
1.	code	number	required	Error code.
2.	text	string(4000)	required	Error message.

### 7.13.2 POST /gateway/notification/cancellation

<b>URI</b>	<b>POST /gateway/notification/cancellation</b>
<b>Description</b>	The method is designed to transfer cancelation request to DataHub for NTK
<b>Parameters</b>	<b>URL:</b> The data of the JSON form request are presented in the HTTP request body ( <b>BODY</b> ) (Query JSON structure, below).

<b>Header</b>	After decrypting the supplier authentication key, the supplier ID is used to save the data.		
<b>JSON request</b>	<pre>{   "cancelledNotificationId": "number",   "cancelledNotificationType": "string",   "consentSign": "boolean",   "objectNumbers": ["string"] }</pre>		
<b>Response HTTP code</b>	<b>HTTP status code</b>	<b>Reason</b>	<b>Description</b>
	201	Created	Request completed successfully
	400	Bad Request	Request error. The HTTP response body provides a list of errors in JSON format. ( <i>Error response of the JSON structure below</i> ).
	401	Unauthorized	An attempt was made to connect to a non-public method that requires authentication, but no user credentials were provided.
	403	Forbidden	According to the access control policy, the current user does not have access to perform the requested action.
	404	Not Found	Either there is no API method associated with the request URL path, or the request contains one or more parameters that did not return the data.
<b>JSON response</b>	<pre>{   „notificationId“: „number“ }</pre>		
<b>JSON error response</b>	<pre>{   "errorMessages": [     {       "code": 0,       "text": "string"     }   ] }</pre>		

Rules	No.	Rule description	Error code	Error message	Attributes
	0.	If an attribute has defined possible values, the value index can be specified by specifying the value of the attribute in the request. Indices of all possible values start from 0.	-	-	-
	1.	The supplier will be identified by the authentication key.	1003	The independent supplier cannot be found in the system or supplier is not active.	Independent_supplier.id, cancellation_notification.independent_supplier_id
	2.	Attributes [ObjectNumber], [cancelledNotificationId], [cancelledNotificationType] are mandatory.	-	One or more request parameters are required.	objectNumber
	3.	<p>The values for the <b>[cancelledNotificationType]</b> attribute must be:</p> <ul style="list-style-type: none"> <li>• STK – Owner and supplier change</li> <li>• NTK – Supplier change</li> <li>• SK – Owner change</li> <li>• SN – Contract termination</li> <li>• KT – Contact change</li> <li>• TPK – Tariff plan change</li> <li>• AP – Supply state change</li> </ul> <p>So far, the cancellation process has been implemented only for the NTK type.</p>	1002	-	cancelledNotificationType

	4.	The meaning of the [ObjectNumber] notification cannot be repeated.	7	The object: [objectNumber (if there is more than one object, objects must be separated by the semicolon)] is repeating	objectNumber
	5.	The Supplier can only cancel requests it has made.	601	The request [cancelledNotificationId] does not belong to the supplier.	objectNumber
	6.	All the objects of the submitted request must belong to the objects of the canceled request.	602	The object: [objectNumber (if there is more than one object, objects must be separated by the semicolon)] does not belong to the cancelled notification [cancelledNotificationId]	objectNumber, cancelledNotificationId
	7.	If the attribute [cancelledNotificationType]=NTK then: <ul style="list-style-type: none"> <li>The latest status of the cancelled request (cancelledNotificationId) must be IV – Completed.</li> </ul>	603	If the cancelled request type is “NTK – Supplier change”, only completed requests can be cancelled.	cancelledNotificationId
	8.	If the attribute [cancelledNotificationType]=NTK , then: <ul style="list-style-type: none"> <li>The cancellation can be made 1 day before the end of the deadline for changing the Supplier.</li> </ul>	604	If the cancelled request type is “NTK – Supplier change”, the cancellation can be made 1 day before the end of the deadline for changing the Supplier.	cancelledNotificationType, cancelledNotificationId

	9	<p>With one cancellation request, it can cancel:</p> <ul style="list-style-type: none"> <li>• a single request, specifying the request and all its objects to be canceled, or</li> <li>• not all objects of a single request, specifying the request to be canceled and its objects to be canceled in that request.</li> </ul>	-	-	-
	10.	<p>Only one non-canceled/non-erroneous cancellation request is possible for the same objectNumber, cancelledNotificationId, cancelledNotificationType, independentSupplierId.</p>	605	<p>The cancellation request for object [<b>objectNumber (if there is more than one object, objects must be separated by the semicolon)</b>] is already submitted to the system</p>	objectNumber, cancelledNotificationId, cancelledNotificationType, independentSupplierId
	11.	<p>The meaning of the [<b>consentSign</b>] must be:</p> <ul style="list-style-type: none"> <li>• <b>True</b> or</li> <li>• <b>False.</b></li> </ul>		-	consentSign
	12.	<p>If the attribute [<b>consentSign</b>] = <b>False</b>, then the cancellation of notification must be disabled.</p>	32	<p>It is necessary to confirm that the data provided is correct.</p>	consentSign
	13.	<p>Upon successful creation of a cancellation request, the status of the request becomes "Submitted".</p>	-	-	-

	13.	If the status of the canceled request [cancelledNotificationId] is IV, then it is checked whether the date_modified of the canceled request is later than the date of the last data import.	606	Due to possible duplication of information, such a notification to object [objectNumber] is not possible. Please try after 30 minutes.	cancelledNotificationId, object number
	14.	It is not possible to cancel if another supplier has already canceled the object contract or independent supplier object valid from date is not equal to contract change notification object's contract start date.	607	A cancellation request for object <b>[objectNumber (if there is more than one object, objects must be separated by the semicolon)]</b> is not possible, another supplier has canceled the contract for the object or the object contract is canceled in the operator's system.	objectNumber, cancelledNotificationId, cancelledNotificationType

### 7.13.2.1 JSON Request structure

The table below describes the structure of the JSON request:

No.	Attribute	type	obligation	description
1.	cancelledNotificationId	Integer	required	Identifier of the cancelation request.
2.	cancelledNotificationType	String(10)	required	<p>Cancelation request type. Possible values are:</p> <ul style="list-style-type: none"> <li>• STK – owner and supplier change</li> <li>• NTK – supplier change</li> <li>• SK – owner change</li> <li>• SN – termination of contract</li> <li>• KT – change of contacts</li> <li>• TPK – Change of tariff plans</li> <li>• AP – Disconnect / connect</li> </ul> <p>For now It is possible submit only type NTK.</p>

No.	Attribute	type	obligation	description
3.	consentSign	Boolean	required	An indication of whether the cancellation data provided is correct.
4.	objectNumbers	String	required	The object number for which the request of object cancellation is performed.

### 7.13.2.2 JSON Response structure

The table below describes the structure of the JSON response:

No.	Attribute	type	obligation	description
1.	notificationId	Integer	required	Request identifier

### 7.13.2.3 Error Response structure

The following table describes the JSON structure in the event of a response error:

No.	Attribute	type	obligation	description
1.	code	number	required	Error code.
2.	text	string(4000)	required	Error message.

### 7.13.3 POST /gateway/notification/{notificationId}/cancellation/cancel

<b>URI</b>	<b>POST /gateway/notification/{notificationId}/cancellation/cancel</b>
<b>Description</b>	The method is designed to cancel cancelation request
<b>Parameters</b>	<b>URL:</b> <ul style="list-style-type: none"> <li><b>notificationId</b> – request identifier. Required</li> </ul>
<b>Header</b>	After decrypting the supplier authentication key, the supplier ID is used to check or supplier cancel his own request

<b>JSON request</b>	In POST request there isn't BODY				
<b>Response HTTP code</b>	<b>HTTP status code</b>	<b>Reason</b>	<b>Description</b>		
	201	Created	Request completed successfully		
	400	Bad Request	Request error. The HTTP response body provides a list of errors in JSON format. ( <i>Error response of the JSON structure below</i> ).		
	401	Unauthorized	An attempt was made to connect to a non-public method that requires authentication, but no user credentials were provided.		
	403	Forbidden	According to the access control policy, the current user does not have access to perform the requested action.		
	404	Not Found	Either there is no API method associated with the request URL path, or the request contains one or more parameters that did not return the data.		
<b>JSON response</b>	-				
<b>JSON error response</b>	<pre>{   "errorMessages":   [     {       "code": 0,       "text": "string"     }   ] }</pre>				
<b>Rules</b>	<b>No.</b>	<b>Rule description</b>	<b>Error code</b>	<b>Error message</b>	<b>Attributes</b>
	0.	If an attribute has defined possible values, the value index can be specified by specifying the value of the	-	-	-



	attribute in the request. Indices of all possible values start from 0.			
1.	<p>The request can be canceled:</p> <ul style="list-style-type: none"> <li>• only one time;</li> <li>• when the notification state is "Pateiktas";</li> <li>• when the cancellation deadline has not passed (Initial value - 1 hour).</li> </ul>	50	According to the given parameters, the message to be canceled could not be found / the cancellation deadline has expired / the message has already been canceled.	-
2.	Upon successful cancellation of the cancellation request, the status of the request becomes "Atšauktas".	-	-	-

### 7.13.3.1 Error Response structure

The following table describes the JSON structure in the event of a response error:

No.	Attribute	type	obligation	description
1.	code	number	required	Error code.
2.	text	string(4000)	required	Error message.

## 7.14 Notification contract object supply state controller *(will be deployed in the future, preliminary date – 10.11)*

### 7.14.1 POST /gateway/notification/contract/object/supply-state/list?first={integer}&count=lation{integer}&sortOrder={ASC/DSC}

<b>URI</b>	POST /gateway/notification/contract/object/supply-state/list?first={integer}&count={integer}&sortOrder={ASC/DSC}
<b>Description</b>	The method is to obtain a list of object's disconnection/connection.

<b>Parameters</b>	<p><b>URL:</b></p> <p><b>first</b> - the index of the notification, which must be the first in the return list (starting from 0). Optional. The default value is 0.  <b>count</b> - the number of notification rows in the return list. Optional. The default value is 30.  <b>sort</b> - possible values ASC, DSC.</p> <ul style="list-style-type: none"> <li>• By default, the list should be sorted by the "notificationId" - the latest request records should be displayed at the top of the list;</li> <li>• Must be able to sort list entries by all list fields except status history;</li> </ul> <p>The data of the JSON form request are presented in the HTTP request body (<b>BODY</b>) (Query JSON structure, below).</p>		
<b>Header</b>	After decrypting the supplier authentication key, the supplier ID is used to select the data.		
<b>JSON request</b>	<pre>{   "notificationId":"number",   "personCode":"string",   "consumerCode":"string",   "objectNumber":"string",   "objectAddressSearch":"string",   "changeType":[     "string"   ],   "status":[     "string"   ],   "submittedDateFrom":"datetime",   "submittedDateTo":"datetime",   "contractType":"string",   "contractModel":"string",   "userNameSearch":"string" }</pre>		
<b>Response HTTP code</b>	<b>HTTP status code</b>	<b>Reason</b>	<b>Description</b>
	200	OK	Request completed successfully
	204	No Content	No data found according to the given parameters.

	400	Bad Request	Request error. The HTTP response body provides a list of errors in JSON format. ( <i>Error response of the JSON structure below</i> ).
	401	Unauthorized	An attempt was made to connect to a non-public method that requires authentication, but no user credentials were provided.
	403	Forbidden	According to the access control policy, the current user does not have access to perform the requested action.
	404	Not Found	Either there is no API method associated with the request URL path, or the request contains one or more parameters that did not return the data.
<b>JSON response</b>	<pre>[   {     "notificationId":"number",     "changeType":"string",     "notes":"string",     "submittedDate":"datetime",     "latestStatus":"string",     "errorType":"string",     "userName":"string",     "currentObjectData":{       "objectNumber":"string",       "objectAddress":"string",       "personName":"string",       "personSurname":"string",       "personCode":"string",       "consumerCode":"string",       "contractType":"string",       "contractModel":"string",       "objectSupplyState":"string",       "objectSupplyStateValidFrom":"date",       "objectSupplyStateValidTo":"date",       "sociallyVulnerable":"boolean"     }   }, </pre>		

	<pre> "supplyStateNotificationStatus":[   {     "status":"string",     "statusDate":"datetime"   } ] } ] </pre>				
<b>JSON error response</b>	<pre> {   "errorMessages": [     {       "code": 0,       "text": "string"     }   ] } </pre>				
<b>Rules</b>	<b>No.</b>	<b>Rule description</b>	<b>Error code</b>	<b>Error message</b>	<b>Attributes</b>
	0.	If an attribute has defined possible values, the value index can be specified by specifying the value of the attribute in the request. Indices of all possible values start from 0.	-	-	All attributes with specified values.
	1.	No data found according to the given parameters.	HTTP 204	-	-

	2.	One or more request parameters are required.	1001	One or more request parameters are required.	-
	3.	DateFrom cannot be later than DateTo. Equal can be.	1002	DateFrom cannot be later than DateTo.	submittedDateFrom, contractTerminationDateFrom

### 7.14.1.1 JSON Request structure

The table below describes the structure of the JSON request:

No.	Attribute	type	obligation	Description
1.	notificationId	Integer	not required	Disconnection/connection notification ID.
2.	personCode	String(20)	not required	Contract owner / tenant person / company code.
3.	consumerCode	String(20)	not required	Contract owner / tenant consumer code.
4.	objectNumber	String(20)	not required	Object number.
5.	objectAddressSearch	String(4000)	not required	Object address. The search by the fragment.
6.	changeType	["string"]	not required	<p>Disconnection/connection change type. Possible meanings:</p> <ul style="list-style-type: none"> <li>• D – Disconnection at the request of the consumer;</li> <li>• DD – Disconnection due to the dept;</li> <li>• C – Connection of the consumer;</li> <li>• CD – Connection of the consumer after payment of the dept.</li> </ul> <p>More than one exchange type can be selected.</p>
7.	status	String(20)	not required	<p>Notification newest status. Possible meanings:</p> <ul style="list-style-type: none"> <li>• P - Submitted</li> <li>• A - Cancelled</li> </ul>

No.	Attribute	type	obligation	Description
				<ul style="list-style-type: none"> <li>• I - Sent</li> <li>• V – In progress</li> <li>• IV - Completed</li> <li>• K - Error</li> </ul> <p>More than one exchange type can be selected.</p>
8.	submittedDateFrom	DateTime	not required	<ul style="list-style-type: none"> <li>• The submission date from of the notification.</li> <li>• Format: yyyy-mm-dd</li> </ul>
9.	submittedDateTo	DateTime	not required	<ul style="list-style-type: none"> <li>• The summation date to of the notification.</li> <li>• Format: yyyy-mm-dd</li> </ul>
10.	contractType	String(20)	not required	<p>Contract type of the current object. Possible meanings:</p> <ul style="list-style-type: none"> <li>• SBTS - Household customer;</li> <li>• SKMS - Commercial customer.</li> </ul>
11.	contractModel	String(10)	not required	<p>Contract model of the current object. Possible meanings:</p> <ul style="list-style-type: none"> <li>• BSS - General contract bills;</li> <li>• 2S2S - Two contracts – Two bills.</li> </ul>
12.	userNameSearch	String(240)	not required	The user who created a notification. Search by the fragment.

#### 7.14.1.2 JSON Response structure

The table below describes the structure of the JSON response:

No.	Attribute	type	obligation	description
1.	notificationId	Integer	required	Disconnection/connection notification ID.
2.	changeType	String(3)	required	<p>Disconnection/connection change type. Possible meanings:</p> <ul style="list-style-type: none"> <li>• D – Disconnection at the request of the consumer;</li> <li>• DD – Disconnection due to the dept;</li> <li>• C – Connection of the consumer;</li> </ul>

No.	Attribute	type	obligation	description
				<ul style="list-style-type: none"> <li>• CD – Connection of the consumer after payment of the dept.</li> </ul>
3.	notes	String(4000)	not required	Notification notes.
4.	submittedDate	DateTime	required	The submission date of the notification.
5.	latestStatus	String(20)	required	Notification newest status. Possible meanings: <ul style="list-style-type: none"> <li>• P - Submitted</li> <li>• A - Cancelled</li> <li>• I - Sent</li> <li>• V – In progress</li> <li>• IV - Completed</li> <li>• K - Error</li> </ul>
6.	errorType	String(10)	not required	Notification error type if status=K (Error). Possible meanings: <ul style="list-style-type: none"> <li>▪ KL - Incorrect message</li> <li>▪ OT – The object has no accounting point</li> <li>▪ BA – Supply state cannot be changed because the data of the old contract does not match</li> <li>▪ KD - Other works completed</li> <li>▪ AD - Unable to perform user on/off operations</li> <li>▪ NB - The facility could not be accessed</li> </ul>
7.	userName	String(240)	not required	The user who created a notification
currentObjectData: {}				
8.	objectNumber	String(20)	required	Object number.
9.	objectAddress	String(4000)	required	Object address.
10.	personName	String(200)	required	Contract owner / tenant / company name.

No.	Attribute	type	obligation	description
11.	personSurname	String(50)	not required	Contract owner / tenant surname.
12.	personCode	String(20)	not required	Person / tenant / company code. If the subject is an individual than person code must be returned encrypted: [*****][the last 3 symbols of the person code]
13.	consumerCode	String(20)	required	Contract owner / tenant consumer code.
14.	contractType	String(10)	required	Contract type of the current object. Possible meanings: <ul style="list-style-type: none"> <li>• SBTS - Household customer;</li> <li>• SKMS - Commercial customer.</li> </ul>
15.	contractModel	String(10)	required	Contract model of the current object. Possible meanings: <ul style="list-style-type: none"> <li>• BSS - General contract bills;</li> <li>• 2S2S - Two contracts – Two bills.</li> </ul>
16.	objectSupplyState	String(3)	not required	Contract object's electricity supply state. Possible meanings: T - Supply; P – Disconnected on request ; A - Disconnected under sanction; R – Limited by sanction.
17.	objectSupplyStateValidFrom	Date	not required	The object's electricity supply status is valid from.
18.	objectSupplyStateValidTo	Date	not required	The object's electricity supply status is valid to.
19.	sociallyVulnerable	Boolean	required	An indication of whether the owner/tenant of the object is socially vulnerable.
supplyStateNotificationStatus:[]				
20.	status	String(10)	required	Notification all status. Possible meanings: <ul style="list-style-type: none"> <li>• P - Submitted</li> <li>• A - Cancelled</li> </ul>



No.	Attribute	type	obligation	description
				<ul style="list-style-type: none"> <li>• I - Sent</li> <li>• V – In progress</li> <li>• IV - Completed</li> <li>• K - Error</li> </ul>
21.	statusDate	DateTime	required	Date of the status.

### 7.14.1.3 Error Response structure

The following table describes the JSON structure in the event of a response error:

No.	Attribute	type	obligation	description
1.	code	number	required	Error code.
2.	text	string(4000)	required	Error message.

### 7.14.2 POST /gateway/notification/contract/object/supply-state

<b>URI</b>	POST /gateway/notification/contract/object/supply-state
<b>Description</b>	The method is for independent supplier to transfer object's disconnection/connection (supply state change) to DataHub.
<b>Parameters</b>	<p><b>URL:</b></p> <p>The data of the JSON form request are presented in the HTTP request body (<b>BODY</b>) (Query JSON structure, below).</p>
<b>Header</b>	After decrypting the supplier authentication key, the supplier ID is used to select the data.

<b>JSON request</b>	<pre>{   "changeType":"string",   "notes":"string",   "consentSign":"boolean",   "objectNumber":"string" }</pre>		
<b>Response HTTP code</b>	<b>HTTP status code</b>	<b>Reason</b>	<b>Description</b>
	201	Created	Request completed successfully
	400	Bad Request	Request error. The HTTP response body provides a list of errors in JSON format. ( <i>Error response of the JSON structure below</i> ).
	401	Unauthorized	An attempt was made to connect to a non-public method that requires authentication, but no user credentials were provided.
	403	Forbidden	According to the access control policy, the current user does not have access to perform the requested action.
	404	Not Found	Either there is no API method associated with the request URL path, or the request contains one or more parameters that did not return the data.
<b>JSON response</b>	<pre>{   "notificationId": "number" }</pre>		
<b>JSON error response</b>	<pre>{   "errorMessages": [     {       "code": 0,       "text": "string"     }   ] }</pre>		

Rules	No.	Rule description	Error code	Error message	Attributes
* Date type fields can be filled with time where it should not be according to the rules below. The time will be clipped automatically and the date will be stored without time.					
	0.	If an attribute has defined possible values, the value index can be specified by specifying the value of the attribute in the request. Indices of all possible values start from 0.	-	-	All attributes with specified values.
	1.	The supplier will be identified by the authentication key.	1003	The independent supplier cannot be found in the system or supplier is not active.	independent_supplier.id, contract_termination_notification. independent_supplier_id
	2.	The attribute [ObjectNumber] is mandatory.	-	-	objectNumber
	3.	Must be specified valid object.	1	Change not possible. The object: [objectNumber] does not found in the system.	objectNumber
	4.	The object must belong to a valid supplier contract that provides the notification.	2	Change not possible. The object: [objectNumber] does not belong to a valid supplier contract.	objectNumber, independentSupplierId, independent_supplier_objects.valid_from, independent_supplier_objects.valid_to, contract.conclusion_date
	5.	If the object does not have a valid electricity	3	Change not possible. The object [objectNumber] does	objectNumber,

	supply status for the current date, the change is not possible.		not have a valid electricity energy supply status.	object_state.state_type
6.	The attribute [changeType] must be: <ul style="list-style-type: none"> <li>• D or</li> <li>• DD or</li> <li>• C or</li> <li>• CD.</li> </ul>	-	-	-
7.	The attribute [changeType] is mandatory.	-	-	changeType
8.	The attribute [changeType] must be = D / DD if the current electricity energy supply state of the object = T - Supply.	4	Change not possible. Object: [objectNumber] current electricity energy supply state is "Supply". Possible change type: "Disconnection at the request of the consumer" or "Disconnection due to the debt".	objectNumber, changeType
9.	The attribute [changeType] must be = C if the current electricity energy supply state of the object = P - Disconnected on request.	5	Change not possible. Object: [objectNumber] current electricity energy supply state is "Disconnected on request". Possible change type: "Connection of the consumer".	objectNumber, changeType
10.	The attribute [changeType] must be = CD if the current electricity energy supply	6	Change not possible. Object: [objectNumber] current electricity energy supply state is "Disconnected under	objectNumber, changeType

	state of the object = A - Disconnected under sanction / R - Limited by sanction.		sanction" or "Limited by sanction". Possible change type: "Connection of the consumer after payment of the debt".	
11.	When submitting a new notification, it must be checked whether the system already has a notification with the status = Completed / In Progress / Sent / Submitted and whose objectNumber, changeType matches the objectNumber, changeType of the newly submitted notification. If such a notification is found, the change is not possible.	7	Change not possible. The notification has already been submitted to [objectNumber].	objectNumber, changeType
12.	The attribute [changeType] must be = C/CC, if attribute [sociallyVulnerable]=True.	8	Change not possible. Object [objectNumber] owner is socially vulnerable.	objectNumber, changeType, sociallyVulnerable
13.	The meaning of the [consentSign] must be: <ul style="list-style-type: none"> <li>• True or</li> <li>• False.</li> </ul>	-	-	consentSign
14.	If the attribute [consentSign] = False, then the contract	32	It is necessary to confirm that the data provided is correct.	consentSign

		termination must be disabled.			
	15.	Upon successful creation of a supply state notification, the status of the notification becomes "Submitted".	-	-	supply_state_notification, supply_state_notification_status

### 7.14.2.1 JSON Request structure

The table below describes the structure of the JSON request:

No.	Attribute	type	obligation	Description
1.	changeType	String(3)	required	Disconnection/connection change type. Possible meanings: <ul style="list-style-type: none"> <li>• D – Disconnection at the request of the consumer;</li> <li>• DD – Disconnection due to the dept;</li> <li>• C – Connection of the consumer;</li> <li>• CD – Connection of the consumer after payment of the dept.</li> </ul> More than one exchange type can be selected.
2.	notes	String(4000)	not required	Notification notes.
3.	consentSign	Boolean	required	The consent sign of the notification. Possible meanings: <ul style="list-style-type: none"> <li>• True or</li> <li>• False.</li> </ul>
4.	objectNumber	String(20)	required	Object number.

### 7.14.2.2 JSON Response structure

The table below describes the structure of the JSON response:

No.	Attribute	type	obligation	description
1.	notificationId	Integer	required	Disconnection/connection notification ID.

### 7.14.2.3 Error Response structure

The following table describes the JSON structure in the event of a response error:

No.	Attribute	type	obligation	description
1.	code	number	required	Error code.
2.	text	string(4000)	required	Error message.

### 7.14.3 POST /gateway/notification/{notificationId}/contract/object/supply-state/cancel

<b>URI</b>	POST /gateway/notification/{notificationId}/contract/object/supply-state/cancel
<b>Description</b>	The method is to cancel the disconnection/connection notification.
<b>Parameters</b>	<b>URL:</b> <i>notificationId</i> – message identifier. Mandatory.
<b>Header</b>	After decrypting the supplier authentication key, the supplier ID is used to select the data.
<b>JSON request</b>	POST request does not have the BODY part.

Response HTTP code	HTTP status code	Reason	Description		
	201	OK	Request completed successfully.		
	400	Bad Request	Request error. The HTTP response body provides a list of errors in JSON format. ( <i>Error response of the JSON structure below</i> ).		
	401	Unauthorized	An attempt was made to connect to a non-public method that requires authentication, but no user credentials were provided.		
	403	Forbidden	According to the access control policy, the current user does not have access to perform the requested action.		
	404	Not Found	Either there is no API method associated with the request URL path, or the request contains one or more parameters that did not return the data.		
<b>JSON response</b>					
<b>JSON error response</b>	<pre>{   "errorMessages": [     {       "code": 0,       "text": "string"     }   ] }</pre>				
Rules	No.	Rule description	Error code	Error message	Attributes
	0.	If an attribute has defined possible values, the value index can be	-	-	All attributes with specified values.



		specified by specifying the value of the attribute in the request. Indices of all possible values start from 0.			
1.	<p>The request can be canceled:</p> <ul style="list-style-type: none"> <li>• only one time;</li> <li>• when the notification state is "Pateiktas";</li> <li>• when the cancellation deadline has not passed (Initial value - 1 hour).</li> </ul>	50	According to the given parameters, the message to be canceled could not be found / the cancellation deadline has expired / the message has already been canceled.	supply_state_notification_status.status, supply_state_notification_status.status.date	
2.	Upon successful cancellation, the status of the notification becomes "Atšauktas".	-	-	supply_state_notification_status.status, supply_state_notification_status.status.date	

### 7.14.3.1 Error Response structure

The following table describes the JSON structure in the event of a response error:

No.	Attribute	type	obligation	description
1.	code	number	required	Error code.
2.	text	string(4000)	required	Error message.

## 7.15 Access rights controller - old

Using this API method, the vendor grants itself the right to access the historical data of the client objects on behalf of the customer. Once the rights have been granted, the supplier can download the customer's historical data for a certain period of time and, on that basis, offer the customer a contract.

### 7.15.1 POST /access-rights/client/data-access-rights

<b>URI</b>	POST /access-rights/client/data-access-rights		
<b>Description</b>	The supplier can grant rights by his self to access clients historical data if has client agreement		
<b>Parameters</b>	none		
<b>Request Body</b>	POST request structure provided in BODY		
<b>Response</b>	<b>HTTP status code</b>	<b>Reason</b>	<b>Response description</b>
	201	Created	Request completed successfully
	400	Bad Request	Request error. The HTTP response body provides a list of errors in JSON format.

	401	Unauthorized	An attempt was made to connect to a non-public method that requires authentication, but no user credentials were provided.
	403	Forbidden	According to the access control policy, the current user does not have access to perform the requested action.
	404	Not Found	Either there is no API method associated with the request URL path, or the request contains one or more parameters that did not return the data.
Rules	No.	Rule description	Attributes
	0.	If an attribute has defined possible values, the value index can be specified by specifying the value of the attribute in the request. Indices of all possible values start from 0.	All attributes with specified values.
	1.	If the object belongs to a household consumer, the term of validity of the right may be a maximum of only 1 year	<b>expires</b>
	2.	If the object belongs to a legal person, the term of validity of the right may be unlimited.  In this software version, expiration time for legal customers is 1 year.	<b>expires</b>
	3.	"clientPermission" field is required and it has only one possible value which is provided in Your agreement/documentation."	<b>clientPermission</b>

### 7.15.1.1 JSON Request structure

The table below describes the JSON structure and elements of the data access rights request:

JSON Request structure
<pre>[   {     "objectNumber": "string",     "customerId": "string",</pre>

```

    "expires": "date",
    "contactEmail": "contactEmail",
    "contactPhone": "contactPhone",
    "contactNotes": "contactNotes",
    "clientPermission": "string"
  }
]

```

Attribute	type	obligation	description
<b>objectNumber</b>	String(20)	required	Object number
<b>customerId</b>	string(32)	required	Customer ID which access right is granted
<b>expires</b>	date	required	The date that determines how long the rights are valid. It is possible to provide a date (in the case of private customer), or "null" (in the case of a legal entity).  ⚠ In this software version, expiration time for legal customers is 1 year.
<b>contactEmail</b>	String(128)	not required	The contact email address of the user who owns the objects.
<b>contactPhone</b>	String(128)	not required	The phone number of the user who owns the items.
<b>contactNotes</b>	String(4000)	not required	Field allowing general type (adjustment) information to be entered.
<b>clientPermission</b>	String(4000)	required	Required value:  "I confirm that the consent of the specified person / company to receive and process personal / company data has been obtained (person's name, surname / company name, person / company code, address, contact details, facility and electricity consumption data)."

### 7.15.1.2 JSON Response structure

If the data access rights request is successful, method will not return any data model, but HTTP 201 Created status.

JSON Response structure

If the request is successful, an **HTTP 201 Created** message is returned

Attribute	type	obligation	description
-	-	-	-

### 7.15.1.3 Response Error codes

Below are the error codes and messages. Response codes and response content in case of error:

Code	Message	Explanation
1	"Object number and customer id combination was not found".	Object number and customer id combination not match any data in DataHub DataBase
2	"Incorrect access right expires date value"	Household customers can have only max 365 days value starting from sysdate when method is calling .
6	" <b>clientPermission</b> field is required and it has only one possible value which is provided in Your agreement/documentation."	The string content in the <b>clientPermission</b> query field does not match the required string content.

#### Response example in case of error

```
{
  "errorMessages": [
    {
      "code": 0,
      "text": "string"
    }
  ]
}
```

### 7.15.2 GET /access-rights/client/granted-objects?first={integer}&count={integer}&sort={ASC/DSC}

<b>URI</b>	GET /access-rights/client/granted-objects?first={integer}&count={integer}&sort={ASC/DSC}
<b>Description</b>	The supplier can get a list of all customers who have granted the rights to the objects.
<b>Parameters</b>	<b>URL</b> parameters:

	<p><b>first</b> - index (starting from 0) of the object that must be presented first in the return list. Optional. The default value is 0.</p> <p><b>count</b> - number of objects in the return list. Optional. The default value is 30.</p> <p><b>sort</b> - sorting by date of grant. Possible values ASC, DSC. The default is ASC.</p>		
<b>Request Body</b>	none		
<b>Response</b>	<b>HTTP status code</b>	<b>Reason</b>	<b>Response description</b>
	204	No Content	Request completed successfully
	400	Bad Request	Request error. The HTTP response body provides a list of errors in JSON format.
	401	Unauthorized	An attempt was made to connect to a non-public method that requires authentication, but no user credentials were provided.
	403	Forbidden	According to the access control policy, the current user does not have access to perform the requested action.
	404	Not Found	Either there is no API method associated with the request URL path, or the request contains one or more parameters that did not return the data.
<b>Rules</b>	<b>No.</b>	<b>Rule description</b>	<b>Attributes</b>
	1.	The vendor authentication key identifies the vendor ID and selects only the rights assigned to that vendor.	<b>Authentication key</b>
	2.	By default, if first, count, sort values are not specified, then the first 30 values of the list of objects and contacts not expired rights are returned according to the most recently granted date.	URL parameters- <b>first, count, sort</b>

### 7.15.2.1 JSON Request structure

The table below describes URL request attributes:

JSON Request structure			
This method has no request data structure.			
Attribute	type	obligation	description
<b>first</b>	integer	not required	Index (starting from 0) of the object that must be presented first in the return list.
<b>count</b>	integer	not required	Number of objects in the return list.
<b>sort</b>	string(3)	not required	Sorting by date of grant. Possible values ASC, DSC. The default is ASC.

### 7.15.2.2 JSON Response structure

The table below describes the JSON structure and elements of client object information response:

JSON Response structure			
<pre>[   {     "customerId": "string",     "objectNumber": "string",     "objectAddress": "string",     "automationLevel": "string",     "clientName": "string",     "expires": "date",     "contactPhone": "contactPhone",     "contactEmail": "contactEmail",     "contactNotes": "contactNotes",     "downloadDate": "date",     "source": "string",     "issueDate": "datetime"   } ]</pre>			
Attribute	type	obligation	description

<b>customerId</b>	string(32)	required	User code of the customer
<b>objectNumber</b>	string(20)	required	Object Number
<b>objectAddress</b>	string(4000)	required	Address of the object
<b>automationLevel</b>	string(7)	not required	Object accounting automation level.
<b>clientName</b>	string(200)	required	Client name:  Name Surname - if household customer Company name - if a legal entity
<b>expires</b>	date	required	The date by which the rights are valid.
<b>contactEmail</b>	string(128)	not required	The contact email address of the user who owns the objects.
<b>contactPhone</b>	string(128)	not required	The phone number of the user who owns the items.
<b>contactNotes</b>	string(4000)	not required	Field allowing general type (adjustment) information to be entered.
<b>downloadDate</b>	datetime	not required	The date and time that tells you when the historical consumption data was last downloaded.
<b>source</b>	string(5)	required	A field describing who granted the rights. Possible values:  "ESO-S" - provided by the customer "NT" - provided by the supplier
<b>issueDate</b>	datetime	required	Date indicating when the right was granted.

### 7.15.3 POST /access-rights/client/data-access-rights/delete

<b>URI</b>	POST /access-rights/client/data-access-rights/delete
<b>Description</b>	The supplier may remove the rights granted to him. He granted the rights himself with the client's permission, or the rights were granted to him by the client through ESO-S. The supplier can remove remove on rights which was granted by himself.
<b>Parameters</b>	none



<b>Request Body</b>	POST request structure provided in BODY		
<b>Response</b>	<b>HTTP status code</b>	<b>Reason</b>	<b>Response description</b>
	204	No Content	Request completed successfully
	400	Bad Request	Request error. The HTTP response body provides a list of errors in JSON format.
	401	Unauthorized	An attempt was made to connect to a non-public method that requires authentication, but no user credentials were provided.
	403	Forbidden	According to the access control policy, the current user does not have access to perform the requested action.
	404	Not Found	Either there is no API method associated with the request URL path, or the request contains one or more parameters that did not return the data.
<b>Rules</b>	<b>No.</b>	<b>Rule description</b>	<b>Attributes</b>
	0.	If an attribute has defined possible values, the value index can be specified by specifying the value of the attribute in the request. Indices of all possible values start from 0.	All attributes with specified values.
	1.	The supplier authentication key determines the supplier ID and selects only the rights assigned to that supplier, selects only those objects for which the rights were granted by the supplier.	<b>Authentication key, source</b>
	2.	The values of customerId and objectNumber are specified. Only the objects for which the rights have been granted by the supplier are selected according to the source field with the value "NT". It is checked whether the specified codes belong to the connected supplier and whether the objects belong to the customer codes and if there is a dependency, the rights are removed from the list.	<b>customerId , objectNumber, supplierId, source</b>

	3.	At least one of the list items (customers or objects) is required to provide to delete rights from DataHub Database rights list.	<b>customers, objects</b>
--	----	--	---------------------------

### 7.15.3.1 JSON Request structure

JSON Request structure			
<pre> [[   "customerId":"string",   "objectNumber":"string" ]] </pre>			
Attribute	type	obligation	description
<b>customerId</b>	string(32)	not required	customer code
<b>objectNumber</b>	String(20)	not required	Object Number

### 7.15.3.2 Response Error codes

Below are the error codes and messages. Response codes and response content in case of error:

Code	Message	Explanation
1	" <b>customerId and objectNumber</b> " do not match. Please check request data.	Could not select matches by specified ID and object codes.
2	"You can not revoke client provided permissions. We can not complete Your request, because access right for <b>customerId or objectNumber</b> was provided from client side."	The supplier specified objects or codes provided by the client that correspond to the ESO-S value in the source field. The supplier cannot remove the customer's consents.

#### Response example in case of error

```

{
  "errorMessages": [
    {

```

```
"code": 0,  
"text": "string"  
}  
]  
}
```